

SIMPLY CLEVER

ŠKODA



ŠKODA Octavia Owner's Manual



Layout of this Owner's Manual (explanations)

This Owner's Manual has been systematically designed to make it easy for you to search for and obtain the information you require.

Chapters, table of contents and subject index

The text of the Owner's manual is divided into relatively short sections which are combined into easy-to-read **chapters**. The chapter you are reading at any particular moment is always specified on the bottom right of the page.

The **Table of contents** is arranged according to the chapters and the detailed **Subject index** at the end of the Owner's Manual helps you to rapidly find the information you are looking for.





Direction indications

All direction indications such as "left", "right", "front", "rear" relate to the direction of travel of the vehicle.

Units of measurement

All values are expressed in metric units.

Explanation of symbols

-  Denotes a reference to a section with important information and safety advice in a chapter.
-  Denotes the end of a section.
-  Denotes the continuation of a section on the next page.
-  Indicates situations where the vehicle must be stopped as soon as possible.
-  Denotes a registered trademark.

Notes

WARNING

The most important notes are marked with the heading **WARNING**. These **WARNING** notes draw your attention to a **serious risk of accident or injury**.

CAUTION

A **Caution** note draws your attention to the possibility of damage to your vehicle (e.g. damage to gearbox), or points out general risks of an accident.



FoR the sake of the environment

An **Environmental** note draws your attention to environmental protection aspects. This is where you will, for example, find tips aimed at reducing your fuel consumption.



Note

A normal **Note** draws your attention to important information about the operation of your vehicle.

Preface

You have opted for a ŠKODA - our sincere thanks for your confidence in us.

You have received a vehicle with the latest technology and range of amenities. Please read this Owner's Manual carefully, because the operation in accordance with these instructions is a prerequisite for proper use of the vehicle.

If you have any questions about your vehicle, please contact a ŠKODA Service Partner.

We wish you much pleasure with your ŠKODA and pleasant motoring at all times.

Your ŠKODA AUTO a.s. (hereinafter referred to as ŠKODA)



The on-board literature

The on-board literature for your vehicle consists of this "**Owner's Manual**" as well as a "**Service schedule**" and the "**Help on the road**" brochure.

Depending on the vehicle model and equipment, other additional operating manuals and instructions may be provided (e.g. an operating manual for the radio).

If one of the publications listed above is missing, please contact a ŠKODA Service Partner.

The Owner's Manual

These operating instructions describe **all possible equipment variants** without identifying them as special equipment, model variants or market-dependent equipment.

Consequently, this vehicle does **not need to contain all of the equipment components** described in this Owner's manual.

The level of equipment of your vehicle refers to your purchase contract of the vehicle. For more information, contact your local ŠKODA retailer.

The **illustrations** can differ in minor details from your vehicle; they are only intended for general information.

The Service Plan:

- includes vehicle data including information on service work performed;
- is a record of services provided;
- is provided for entries relating to the mobility warranty (valid only for some countries);
- serves as warranty certificate of the ŠKODA dealer.

The service records are one of the conditions for warranty claims.

Please always present the Service schedule when you take your car to a ŠKODA specialist garage.

If the Service Schedule is missing or worn, please contact the ŠKODA specialist garage that regularly services your car. You will receive a duplicate, in which the previously carried out service work is confirmed by the ŠKODA specialist garage.

The Help on the Road brochure

The brochure contains the important emergency telephone numbers as well as telephone numbers and contact addresses of ŠKODA Service Partners in different countries.

Table of Contents

Abbreviations

Using the system

Cockpit	7
Overview	6
Instruments and warning lights	8
Instrument cluster	8
Multifunction display (onboard computer)	12
MAXI DOT (information display)	15
Warning lights	18
Unlocking and locking	26
Vehicle key	26
Child safety lock	27
Central locking system	27
Remote control	30
Anti-theft alarm system	31
Boot lid	33
Electric power windows	34
Electric sliding/tilting roof	37
Lights and visibility	39
Lights	39
Interior light	45
Visibility	47
Windscreen wipers and washers	48
Rear window	51
Seats and Stowage	54
Front seats	54
Seat heaters	57
Head restraints	58
Rear seats	59
Boot	60

Variable loading floor in the boot	64
Net partition (Combi)	65
Roof rack system	66
Cup holder	68
Ashtray	68
Cigarette lighter, 12-volt power socket	69
Storage compartments	70
Clothes hooks	77
Parking ticket holder	77

Heating and air conditioning system	79
Heating and air conditioning system	79
Air outlet vents	80
Heating	80
Air conditioning system (manual air conditioning system)	82
Climatronic (automatic air conditioning system)	85
Auxiliary heating (auxiliary heating and ventilation)	87

Starting-off and Driving	91
Starting and stopping the engine	91
Brakes and brake assist systems	93
Shifting (manual gearbox)	97
pedals	97
Parking aid	98
Cruise control system (CCS)	99
START/STOP	100

Automatic gearbox	102
Automatic gearbox	102

Communication	107
Mobile phones and two-way radio systems	107
Operating the phone on the multifunction steering wheel	108
Symbols in the information display	109
Phone Phonebook	109
Universal telephone preinstallation GSM II	109
Universal telephone preinstallation GSM III	112

Voice control	116
Multimedia	118

Safety

Passive Safety	121
General information	121
Correct seated position	122
Seat belts	125
Seat belts	125
Airbag system	129
Description of the airbag system	129
Front airbags	130
Side airbags	131
Head airbags	132
Deactivating airbags	133
Transporting children safely	135
Child seat	135

Driving Tips

Driving and the Environment	139
The first 1 500 km	139
Catalytic converter	139
Economical and environmentally friendly driving	140
Environmental compatibility	142
Driving abroad	143
Avoiding damage to your vehicle	143
Driving through water on the street	144
Towing a trailer	145
Towing a trailer	145

General Maintenance

Taking care of and cleaning the vehicle	148
Taking care of your vehicle	148

Inspecting and replenishing	155
Fuel	155
Engine compartment	158
Vehicle battery	165

Wheels and Tyres	170
Tyres	170

Accessories, changes and replacement of parts	177
Introductory information	177
Changes and impairments of the airbag system	177

Do-it-yourself

Do-it-yourself	178
First-aid kit and warning triangle	178
Fire extinguisher	178
Vehicle tool kit	179
Changing a wheel	179
Breakdown kit	182
Jump-starting	185
Towing the vehicle	186

Fuses and light bulbs	189
Fuses	189
Bulbs	191

Technical data

Technical data	197
Introductory information	197
Data on the vehicle data sticker and the type plate	197
Dimensions	198
Specifications and engine oil capacity	200
Vehicle-specific information depending on engine type	201
Multi-purpose vehicles (AF)	207

Index

Abbreviations

Abbreviation	Definition
rpm	Engine revolutions per minute
ABS	Anti-lock brake system
AF	Multi-purpose vehicles
AG	Automatic gearbox
TCS	Traction control
CO ₂ in g/km	discharged quantity of carbon dioxide in grams per driven kilometer
DPF	Diesel particle filter
DSG	Automatic double clutch gearbox
DSR	Active driver-steering recommendation
EDL	Electronic differential lock
EPC	EPC fault light
ESC	Electronic Stability Control
kW	Kilowatt, measuring unit for the engine output
MG	Manual gearbox
MFD	Multifunction display
N1	Panel van intended exclusively or mainly for the transportation of goods
Nm	Newton meter, measuring unit for the engine torque
TDI CR	Diesel engine with turbocharging and common rail injection system
TDI PD	Diesel engine with injection system and unit injector injection system
TSI	Petrol engine with turbocharging and direct injection

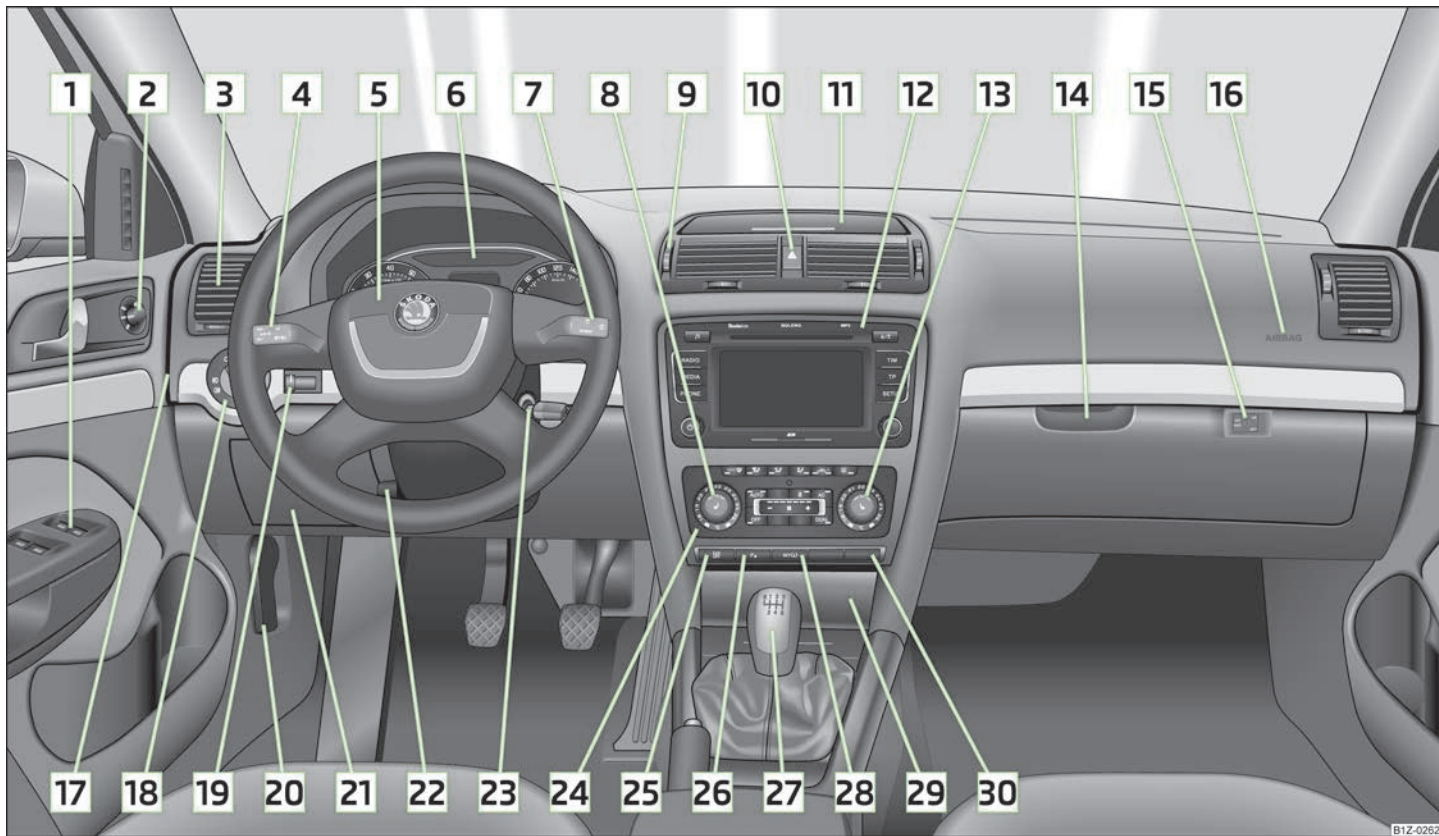

Fig.1 Cockpit

Using the system

Cockpit

Overview

1	Electric windows	34
2	Electric exterior mirror adjustment	52
3	Air outlet vents	80
4	Lever for the multifunction switch: <ul style="list-style-type: none">> Turn signal light, headlight and parking light, headlight flasher> Speed regulating system	45 99
5	Steering wheel: <ul style="list-style-type: none">> With horn> With driver's front airbag> with pushbuttons for radio, navigation system and mobile phone	130 108, 118
6	Instrument cluster: Instruments and warning lights	8
7	Lever for the multifunction switch: <ul style="list-style-type: none">> Multifunction display> Windscreen wiper and wash system	12 48
8	Regulator for front left seat heating	57
9	Air outlet vents	80
10	Switch for hazard warning lights	44
11	Storage compartment on the dash panel	72
12	Depending on equipment fitted: <ul style="list-style-type: none">> Radio> Navigation system	
13	Regulator for front right seat heating	57
14	Storage compartment on the front passenger side	71
15	Key switch for switching off the front passenger airbag (in front passenger storage compartment)	133
16	Front passenger airbag	130
17	Fuse box (on side of dash panel)	190
18	Light switch	40
19	Regulator for the instrument lighting and regulator for the headlight beam range adjustment	43, 44
20	Bonnet release lever	160
21	Storage compartment on the driver's side	71
22	Lever for adjusting the steering wheel	92
23	Ignition lock	93
24	Depending on equipment fitted: <ul style="list-style-type: none">> Operating controls for the heating> Operating controls for the air conditioning system> Operating controls for Climatronic	80 82 85
25	TCS switch	96
26	Front and rear parking aid	98
27	Depending on equipment fitted: <ul style="list-style-type: none">> Gearshift lever (manual gearbox)> Selector lever (automatic gearbox)	97 103
28	Tyre pressure monitoring system	175
29	Depending on equipment fitted: <ul style="list-style-type: none">> Ashtrays> Storage compartment	68 72
30	Warning light for the deactivated front seat passenger airbag	133

i Note

The arrangement of the controls and switches and the location of some items on right-hand drive models may differ from that shown in > Fig. 1. The symbols on the controls and switches are the same as for left-hand drive models.

Instruments and warning lights

Instrument cluster

Introduction

This chapter contains information on the following subjects:

Overview	8
Engine revolutions counter	9
Speedometer	9
Coolant temperature gauge	9
Fuel gauge	9
Counter for distance driven	10
Service Interval Display	10
Digital clock	11
Recommended gear	11

! WARNING

- Concentrate fully at all times on your driving! As the driver you are fully responsible for the operation of your vehicle.
- Never operate the controls in the instrument cluster while driving, only when the vehicle is stationary!

Overview

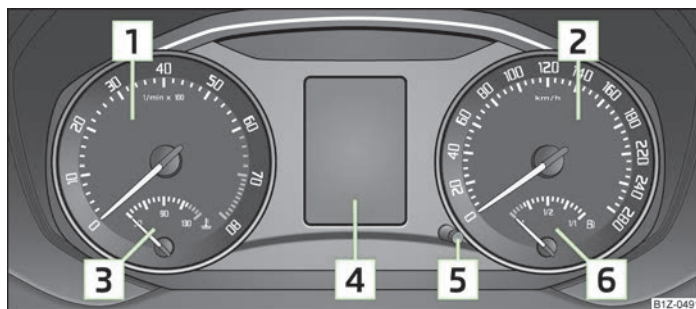

Fig. 2 Instrument cluster

First read and observe the introductory information and safety warnings ! on page 8.

- 1 Engine revolutions counter » page 9
- 2 Speedometer » page 9
- 3 Coolant temperature gauge » page 9
- 4 Display:
 - > With counter for distance driven » page 10
 - > With service interval display » page 10
 - > With digital clock » page 11
 - > With multifunction display » page 12
 - > With information display » page 15
- 5 Knob for the selection of the mode (turn knob)/the setting (press knob):
 - > Setting the hours/minutes
 - > Activating/deactivating the second speed in mph or km/h
 - > Service intervals - Display of the number of days and kilometres remaining until the next Inspection Service
 - > Reset trip counter for the distance driven
 - > Resetting Service Interval Display
 - > Activate/deactivate display mode
- 6 Fuel gauge » page 9

Engine revolutions counter



First read and observe the introductory information and safety warnings  on page 8.

The red scale of the rev counter  » Fig. 2 on page 8 indicates the range in which the engine control unit begins to limit the engine speed. The engine control unit restricts the engine speed to a steady limit.

You should shift into the next higher gear before the red scale of the revolution counter is reached, or move the selector lever into position D if your car is fitted with an automatic gearbox.

To maintain the optimum motor speed, observe the gearshift indicator » page 11.



For the sake of the environment

Shifting to a higher gear in good time helps to lower fuel consumption, minimises operating noise levels, protects the environment and contributes to a longer life and reliability of the engine.

Speedometer



First read and observe the introductory information and safety warnings  on page 8.

Warning against excessive speeds

An audible warning signal will sound when the vehicle speed exceeds 120 km/h. The audible warning signal is switched off when the vehicle speed falls below this speed limit.



Note

This function is only valid for some countries.

Coolant temperature gauge



First read and observe the introductory information and safety warnings  on page 8.

The coolant temperature gauge  » Fig. 2 on page 8 operates only when the ignition is switched on.

The following guidelines regarding the temperature ranges must be observed to avoid any damage to the engine.

Cold range

If the pointer is still in the left area of the scale it means that the engine has not yet reached its operating temperature. Avoid high speeds, full throttle and high engine loads.

The operating range

The engine has reached its operating temperature as soon as the pointer moves into the mid-range of the scale, for a normal style of driving. The pointer may also move further to the right at high engine loads and high outside temperatures.



CAUTION

Additional headlights and other attached components in front of the fresh air inlet impair the cooling efficiency of the coolant. There is then a risk of the engine overheating at high outside temperatures and high engine loads » page 20.

Fuel gauge



First read and observe the introductory information and safety warnings  on page 8.

The fuel gauge  » Fig. 2 on page 8 only operates when the ignition is switched on.

The fuel tank has a capacity of about 55 litres or 60 litres ¹⁾. The warning light in the instrument cluster lights up when the pointer reaches the reserve marking  » page 23.

An audible signal sounds as a warning signal.

¹⁾ Valid for Octavia Combi 4x4 and Octavia Scout.

! CAUTION

Never drive until the fuel tank is completely empty! An irregular supply of fuel can lead to irregular engine running. Unburnt fuel may get into the exhaust system and damage the catalytic converter.

i Note

After filling up, it can occur that during dynamic driving (e.g. numerous curves, braking, driving downhill and climbing a steep hill) the fuel gauge indicates approx. a fraction less. When stopping or during less dynamic driving, the fuel gauge displays the correct fuel level again. This is not a fault.

Counter for distance driven

 First read and observe the introductory information and safety warnings **!** on page 8.

The distance which you have driven with your vehicle is shown in kilometres (km). In some countries the measuring unit miles (mph) is used.

Daily trip counter (trip)

The daily trip counter indicates the distance which you have driven since it was last reset - in steps of 100 metres or 1/10 of a mile.

Press the button **[5]** » Fig. 2 on page 8 for more than 1 second to reset the display of the daily trip counter.

Odometer

The odometer indicates the total distance in kilometres or miles which the vehicle has been driven.

Fault display

If there is a fault in the instrument cluster **Error** will appear continuously in the display. Ensure the fault is rectified as soon as possible by ŠKODA a specialist garage.

i Note

For vehicles fitted with the information display, if the display of the second speed is activated in mph or km/h, this driving speed is indicated instead of the counter for the total distance driven.

Service Interval Display



Fig. 3
Service Interval Display: Note

 First read and observe the introductory information and safety warnings **!** on page 8.

The display can vary depending on the equipment.

Service Interval Display

Before the next service interval a key symbol  and the remaining kilometres are indicated for 10 seconds after switching on the ignition » Fig. 3. At the same time, the remaining days until the next service interval are displayed.

The following is displayed in the information display:

Service in ... km or ... days.

The kilometre indicator or the days indicator reduces in steps of 100 km or, where applicable, days until the service due date is reached.

As soon as the due date for the service is reached, a flashing key symbol  and the text **Service** appears in the display for 20 seconds after the ignition has been switched on.

The following is displayed in the information display:

Service now!

Displaying the distance and days until the next service interval

You can use the button **[5]** to display the remaining distance and the days until the next service interval » Fig. 2 on page 8.

A key symbol  and the remaining distance appear for 10 seconds in the display. At the same time, the remaining days until the next service interval are displayed.

On vehicles which are equipped with the information display, you can call up this display in the menu **Settings** » page 16.

The following will be displayed in the information display for 10 seconds:

Service in ... km or ... days.

Resetting Service Interval Display

It is only possible to reset the Service Interval Display, if a service message or at least a pre-warning is shown in the instrument cluster display.

We recommend that this reset is completed by a ŠKODA specialist garage.

The ŠKODA specialist garage:

- Resets the memory of the display after the appropriate inspection
- Adds an entry to the Service Schedule
- Affixes the sticker with the entry of the following service interval to the side of the dashboard on the driver's side

Reset the service interval display by using the knob **[5]** » Fig. 2 on page 8.

On vehicles which are equipped with the information display, you can reset the Service Interval Display in the menu **Settings** » page 16.

! CAUTION

We recommend that you do not reset the Service Interval Display yourself as this can result in the incorrect setting of the Service Interval Display, which can also cause possible problems with the operation of your vehicle.

i Note

- Never reset the display between service intervals, as this will result in the incorrect display.
- Information is retained in the Service Interval Display even after the vehicle battery is disconnected.
- If the instrument cluster is exchanged after a repair, the correct values must be entered in the counter for the Service Interval Display. This work is carried out by a ŠKODA specialist garage.
- After resetting the display with flexible service intervals, the displayed data is the same as that for a vehicle with fixed service intervals. We therefore recommend that the Service Interval Display is only reset by a ŠKODA Service Partner, who will reset the display with a vehicle system tester.
- For more information on the service intervals » *Service Plan*.

Digital clock

 First read and observe the introductory information and safety warnings **[!]** on page 8.

The clock is set using the knob **[5]** » Fig. 2 on page 8.

Turn the knob **[5]** to select the display you wish to change. Make the change by pressing the knob.

On vehicles that are fitted with the information display, it is also possible to set the clock in the menu **Time** » page 16.

Recommended gear

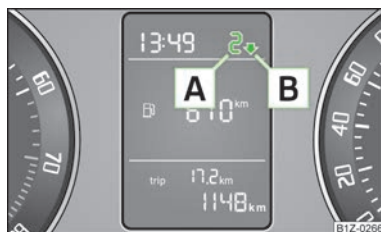

Fig. 4
Recommended gear

 First read and observe the introductory information and safety warnings **[!]** on page 8.

The currently engaged gear **[A]** is shown in the instrument cluster display » Fig. 4.

In order to minimise the fuel consumption, a recommendation for shifting into another gear is indicated in the display.

If the control unit recognises that it is beneficial to change gear, an arrow **[B]** is shown in the display. The arrow points up or down, depending on whether you should shift into a higher or lower gear.

At the same time, the recommended gear is indicated instead of the currently engaged gear **[A]**.

! CAUTION

The driver is always responsible for selecting the correct gear in different driving situations, such as overtaking.

Multifunction display (onboard computer)

Introduction

This chapter contains information on the following subjects:

Memory	12
Operation	13
Multifunction display details	13
Warning against excessive speeds	14

The multifunction display can only be operated when the ignition is switched on. After the ignition is switched on, the function displayed is the one which you last selected before switching off the ignition.

The multi-functional indicator appears in the display » Fig. 5 on page 12 or in the information display » page 15 depending on the equipment fitted to your vehicle.

In vehicles with an information display » page 15, there is an option to fade out some of the information.

! WARNING

- Concentrate fully at all times on your driving! As the driver you are fully responsible for the operation of your vehicle.
- Do not only rely upon the information given on the outside temperature display that there is no ice on the road. Even at temperatures around +4 °C, black ice may still be on the road surface – warning, drive with care!

i Note

- In certain national versions the displays appear in the Imperial system of measures.
- If the display of the second speed is activated in mph, the current speed is not indicated in km/h on the display.

Memory



Fig. 5
Multifunction display

First read and observe the introductory information and safety warnings ! on page 12.

The multifunction display is equipped with two automatic memories. The selected memory is shown in the Display » Fig. 5.

The data of the single-trip memory (memory 1) is shown if a 1 appears in the display. A 2 shown in the display means that data relates to the total distance memory (memory 2).

Switching over the memory using the button **B** » Fig. 6 on page 13 on the windscreen wiper lever or using the adjustment wheel **D** on the multifunction steering wheel.

Single-trip memory (memory 1)

The single-trip memory collates the driving information from the moment the ignition is switched on until it is switched off. New data will also flow into the calculation of the current driving information if the trip is continued **within 2 hours** after switching off the ignition. If the trip is interrupted for **more than 2 hours**, the memory is automatically erased.

Total-trip memory (memory 2)

The total-trip memory gathers data from any number of individual journeys up to a total of 19 hours and 59 minutes driving or 1 999 kilometres driven, and on vehicles which are fitted with an information display up to a total of 99 hours and 59 minutes driving or 9 999 kilometres driven. The memory is deleted when either of these limits is reached and the calculation starts all over again.

Unlike the single-trip memory, the total-trip memory is not deleted after a period of interruption of driving of 2 hours.

i Note

All information in the memory 1 and 2 is erased if the battery of the vehicle is disconnected.

Operation

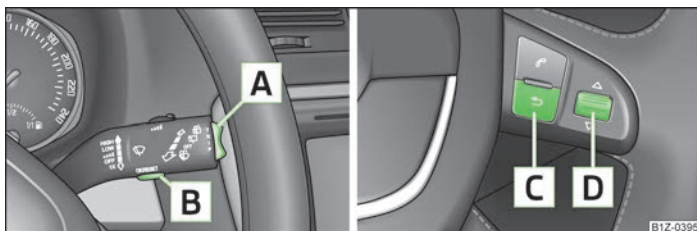





Fig. 6 Multifunction display: Control elements on the windscreen wiper lever/control elements on the multifunction steering wheel

 First read and observe the introductory information and safety warnings  on page 12.

The rocker switch  » Fig. 6 and the button  are located on the windscreen wiper lever. Switching over and resetting is performed with the adjustment wheel  on the multifunction steering wheel.

Select memory

» Press the button  » Fig. 6 or .

Selecting functions using the windscreen wiper lever

» Briefly press the rocker switch  » Fig. 6 up or down. This opens the individual functions of the multifunction display one after the other.



Selecting functions using the multifunction steering wheel

» Press the button  » Fig. 6.

» Turn the adjustment wheel  upwards or downwards. This opens the individual functions of the multifunction display one after the other.

Resetting

- » Select the desired memory.
- » Press and hold the button  » Fig. 6 or  for a short while.

The following readouts of the selected memory will be set to zero with the button  » Fig. 6 or .

- » Average fuel consumption
- » Distance driven
- » Average speed
- » Driving time



Multifunction display details





First read and observe the introductory information and safety warnings  on page 12.

Outside temperature

The current outside temperature is shown in the display.

If the outside temperature drops below +4 °C, a snow flake symbol (warning signal for ice on the road) appears before the temperature indicator and an audible signal will sound. After pressing the rocker switch  » Fig. 6 on page 13 or , the function shown last is indicated.

Driving time

The driving time which has elapsed since the memory was last erased, appears in the display. If you wish to measure the driving time from a particular time, you need to set the memory to zero at this point in time by pressing the button  » Fig. 6 on page 13 or  for more than 1 second.

The maximum time indicated in both memories is 19 hours and 59 minutes and on vehicles which are fitted with an information display, it is 99 hours and 59 minutes. The indicator is set back to zero if this period is exceeded.

Current fuel consumption

The current fuel consumption level is shown in the display in litres/100 km¹⁾. You can use this information to adapt your driving style to the desired fuel consumption.

¹⁾ On some models in certain countries, the display appears in kilometres/litre.

The display appears in litres/hour if the vehicle is stationary or driving at a low speed¹⁾.

Average fuel consumption

The average fuel consumption since the memory was last erased is shown in the display in litres/100 km²⁾ » page 12.

If you wish to determine the average fuel consumption over a certain period of time, you must set the memory at the start of the new measurement to zero using the button **[B]** » Fig. 6 on page 13. After erasing the memory, no value appears in the display until you have driven 300 m.

The display is updated regularly while you are driving.

Range

The estimated range in kilometres is shown on the display. It indicates the distance you can still drive with your vehicle based on the level of fuel in the tank and the same style of driving.

The display is shown in steps of 10 km. After lighting up of the warning light for the fuel reserve the display is shown in steps of 5 km.

The fuel consumption over the last 50 km is used to calculate the range. The range will increase if you drive in a more economical manner.

If the memory is set to zero (after disconnecting the battery), the fuel consumption of 10 ltr./100 km is calculated for the range; afterwards the value is adapted accordingly to the style of driving.

Distance travelled

The distance driven since the memory was last erased appears in the display » page 12.

If you wish to measure the distance travelled from a particular point in time, you need to set the memory to zero at this point in time by pressing the button **[B]** » Fig. 6 on page 13 or **[D]**.

The maximum distance indicated in both memories is 1 999 km or 9 999 km on vehicles with an information display. The indicator is set back to zero if this period is exceeded.

¹⁾ On some models in certain countries, the display appears in --,-- kilometres/litres if the vehicle is stationary.

²⁾ On some models in certain countries, the display appears in kilometres/litre.

Average speed

The average speed since the memory was last erased is shown in the display in km/hour » page 12. If you wish to determine the average speed over a certain period of time, you need to set the memory to zero at the start of the measurement using the button **[B]** » Fig. 6 on page 13 or **[D]**.

After erasing the memory, no value appears in the display until you have driven approx. 300 m.

The display is updated regularly while you are driving.

Current speed

The current speed which is identical to the display of the speedometer **[2]** » Fig. 2 on page 8 is indicated on the display.

Oil temperature

If the oil temperature is lower than 50 °C or if a fault in the system for checking the oil temperature is present, -- -- is displayed instead of the oil temperature.

Warning against excessive speeds



First read and observe the introductory information and safety warnings **[!] on page 12.**

Adjust the speed limit while the vehicle is stationary

- » With the button **[A]** » Fig. 6 on page 13 or, if applicable, the adjustment wheel **[D]**, select the menu item **Warning against excessive speeds**.
- » Press the button **[B]** or **[D]** to activate the ability to set the speed limit (value flashes).
- » Set the desired speed limit, e.g. 50 km/h, with the button **[A]** or, if applicable, the adjustment wheel **[D]**.
- » Press the button **[B]** or **[D]** to confirm the set speed limit, or wait approx. 5 seconds and the setting is saved automatically (the value stops flashing).

This allows you to set the speed in 5 km/h intervals.

Adjusting the speed limit while the vehicle is moving

- » With the button **[A]** » Fig. 6 on page 13 or, if applicable, the adjustment wheel **[D]**, select the menu item **Warning against excessive speeds**.
- » Drive at the desired speed, e.g. 50 km/h.

- Press the button **B** or **D** to accept the current speed as the speed limit (the value flashes).

If you wish to change the set speed limit, it is changed in 5 km/h intervals (e.g. the accepted speed of 47 km/h increases to 50 km/h or decreases to 45 km/h).

- Press again the button **B** or **D** to confirm the speed limit, or wait approx. 5 seconds and the setting is saved automatically (the value stops flashing).

Change or delete speed limit

- With the button **A** » Fig. 6 on page 13 or, if applicable, the adjustment wheel **D**, select the menu item **Warning against excessive speeds**.
- Pressing the button **B** or **D** deletes the speed limit.
- Pressing the button **B** or **D** again activates change mode for the speed limit.

If the set speed limit is exceeded, an audible signal will sound as a warning. At the same time the message **Warning against excessive speeds** appears on the display with the set limit value.

The set speed limit value remains stored even after switching off the ignition.

MAXI DOT (information display)

Introduction

This chapter contains information on the following subjects:

Main menu	15
Settings	16
Door, boot lid and bonnet warning	17
Auto Check Control	17

The information display provides you with information on the **current operating state of your vehicle**. The information system also provides you with data (depending on the equipment installed in the vehicle) relating to the radio, mobile phone, multi-functional indicator, navigation system, the unit connected to the MDI input and the automatic gearbox » page 102.

WARNING

Concentrate fully at all times on your driving! As the driver you are fully responsible for the operation of your vehicle.

CAUTION

Pull out the ignition key if coming in contact with the display (e.g. when cleaning) to prevent any possible damage.

Main menu

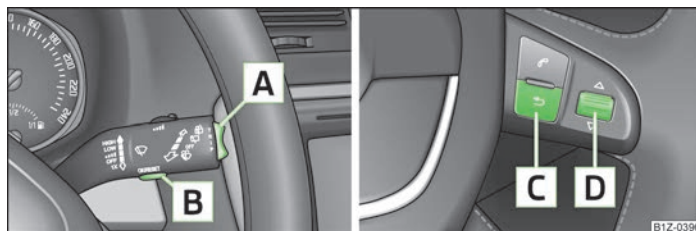

Fig. 7 Information display: Control elements on the windscreen wiper lever/ control elements on the multifunction steering wheel

First read and observe the introductory information and safety warnings **I** on page 15.

Operating with the buttons on the windscreen wiper lever

- Activate the **Main menu** by pressing the rocker switch **A** » Fig. 7 for longer.
- Individual menu items can be selected by means of the rocker switch **A**. When the pushbutton **B** is briefly pressed, the information you have selected is displayed.

Operating with the buttons on the multifunction steering wheel

- Activate the **Main menu** by pressing and holding the button **C** » Fig. 7 for a short while.
- By briefly pressing the **C** button you will reach one level higher.
- The individual menus can be selected by pressing the adjustment wheel **D**. The selected menu is displayed after briefly pressing the adjustment wheel **D**.

The following information can be selected (depending on the equipment installed on the vehicle):

- **MFD** » page 12
- **Audio** » *Operating instructions for the radio*
- **Navigation** » *Operating instructions for the navigation system*

- **Phone** » page 107
- **Aux. Heating** » page 87
- **Assistants** » page 41
- **Vehicle status** » page 17
- **Settings** » page 16

The menu items **Audio** and **Navigation** are only displayed when the factory-fitted radio or navigation system is switched on.

The menu item **Aux. heating** is only displayed if a factory-fitted auxiliary heating is installed.

The menu point **Assistants** is only then displayed, if the vehicle is fitted with cornering lights.

Note

- If warning messages are shown in the information display, these messages must be confirmed with the button **[B]** » Fig. 7 on the windscreen wiper lever or with the button **[D]** on the multifunction steering wheel to call up the main menu.
- If the information display is not activated at that moment, the menu always shifts to one of the higher levels after approx. 10 seconds.

Settings



First read and observe the introductory information and safety warnings  on page 15.

You can change certain settings by means of the information display. The current setting is shown on the information display in the respective menu at the top below the line.

The following information can be selected (depending on the equipment installed on the vehicle):

- **Language**
- **MFD Data**
- **Convenience**
- **Lights & Vision**
- **Time**
- **Winter tyres**
- **Units**
- **Assistants**
- **Alternative speed displayed**

- **Service**
- **Factory setting**
- **Back**

Select the menu item **Back** to return to one level higher in the menu.

Language

You can set the language for the warning and information texts here.

MFD displays

Activate or deactivate certain displays of the multifunction display here.

Comfort

This is where the following functions can be activated, deactivated or adjusted:

Rain closing	Switch on/off the function for automatically closing the window and panoramic tilt/slide sunroof in a locked vehicle when it starts raining ^{a)} . If the function is set and it is not raining, the windows including the panoramic tilt/slide sunroof will close automatically after approx. 12 hours.
Central locking	Switch on/off the central locking and automatic locking function.
ATA confirm	Switch on/off the audible signal indicating activation of the anti-theft alarm system.
Window op.	Only convenience mode for the driver window or for all of the windows can be adjusted here.
Mirror down	Switch on/off the function for mirror lowering on the front passenger side when engaging the reverse gear ^{b)} .
Mirror adjust.	Switch on/off the function for left and right exterior mirror setting simultaneously.
Factory setting	Restore the Convenience factory setting.

^{a)} This function is only available on vehicles with a rain sensor.

^{b)} This function is only available on vehicles with an electrically adjustable driver seat.

Lights and visibility

This is where the following functions can be activated, deactivated or adjusted:

Coming Home	Switch on/off and adjust the light duration of the COMING HOME function.
Leaving Home	Switch on/off and adjust the light duration of the LEAVING HOME function.

Dayl. dri. light	Switch on/off the "DAY LIGHT" function.
Rear wiper	Switch on/off the function for automatic rear window wiping.
Lane ch. flash	Switch on/off the convenience flashing function.
Travel mode	Switch on/off the travel model function.
Factory setting	Restore the factory setting for the lighting.

Time

The time, time format (12 or 24 hour indicator) and the changeover between summer/winter time can be set here.

Winter tyres

Here, you can set the speed at which an audible signal should sound. This function is, for example, used for winter tyres where the maximum permissible speed is lower than the maximum speed of the vehicle.

When exceeding the speed, the following is shown on the information display:

Winter tyres: max. speed ... km/h

Units of measurement

The units for the temperature, consumption and distance driven can be set here.

Assistants

The tones of the audible signals for the parking aid can be adjusted here.

Second speed

The display of the second speed in mph or in km/h can be switched on here.

Service

Here you can have the remaining kilometres and days until the next service interval displayed, and reset the Service Interval Display.

Factory setting

After selecting the menu **Factory setting** the factory setting of the information display is restored.

Door, boot lid and bonnet warning



First read and observe the introductory information and safety warnings on page 15.

If at least one door is open, or the boot or bonnet is open, the information display indicates the relevant **open door** or boot/bonnet.

An audible signal also sounds if the vehicle is travelling at more than 6 km/h.

Auto Check Control



First read and observe the introductory information and safety warnings on page 15.





Vehicle condition

Certain functions and conditions of individual vehicle systems are checked continuously when the ignition is switched on and also while driving.

Some error messages and other information are displayed in the information display. The messages are displayed at the same time as the symbols in the information display or the warning lights in the instrument cluster » page 18.

If there is at least one error message, the menu item **Vehicle status** is displayed in the menu. After selecting this menu the first of the error messages is displayed. Several error messages are shown on the display under the message e.g. **1/3**. This indicates that the first of a total of three error messages is being displayed.

Warning symbols

	Engine oil pressure too low	» page 21
	Clutches of the automatic gearbox DSG are too hot	» page 17
	Check engine oil level, engine oil sensor faulty	» page 21
	Problem with engine oil pressure	» page 18

Clutches of the automatic gearbox DSG are too hot

A symbol  in the information display indicates that the temperature of the clutches of the automatic gearbox is too high.

The following is displayed in the information display:

Gearbox overheated. Stop! Owner's man.!

Stop the vehicle, switch off the engine, and wait until the symbol  disappears - risk of gearbox damage! You can continue your journey as soon as the symbol disappears.

Problem with the engine oil pressure 

If the symbol  is shown in the information display, you must have your vehicle checked immediately by a ŠKODA specialist garage. The information about the maximum permissible engine speed is displayed together with this symbol.

! WARNING

If you have to stop for technical reasons, then park the vehicle at a safe distance from the traffic, switch off the engine and activate the hazard warning light system » [page 44](#).





i Note

















As long as the operational faults are not rectified, the symbols are always indicated again. After they are displayed for the first time, the symbols continue to be indicated without any extra messages for the driver.









Warning lights

Overview

The warning lights show certain functions/faults and may be accompanied by audible signals.

	Handbrake	» page 19
	Brake system	» page 19
	Seat belt warning light	» page 19
	Generator	» page 20

	Open door	» page 20
	Coolant temperature/coolant level	» page 20
	Bonnet	» page 20
	Boot lid	» page 21
	Engine oil	» page 21
	Electromechanical power steering	» page 21
	Traction control (TCS)	» page 21
	Electronic Stability Control (ESC)	» page 22
	Antilock brake system (ABS)	» page 22
	Rear fog light	» page 22
	Bulb failure	» page 22
	Exhaust inspection system	» page 22
	Glow plug system (diesel engine)	» page 23
EPC	EPC fault light (petrol engine)	» page 23
	Diesel particle filter (diesel engine)	» page 23
	Fuel reserve	» page 23
	Airbag system	» page 24

	Tyre control display	» page 24
	Windscreen washer fluid level	» page 24
	Traction control (TCS) switched off	» page 24
	Turn signal (left/right).	» page 24
	Fog lights	» page 24
	Speed regulating system	» page 25
	Low beam	» page 25
	Selector lever lock	» page 25
	Main beam	» page 25

WARNING

- If illuminated warning lights and the corresponding descriptions and warning notes are not observed, this may result in severe injuries or major vehicle damage.
- The engine compartment of your car is a hazardous area. There is a risk of injuries, scalding, accidents and fire when working in the engine compartment, e.g. inspecting and replenishing oil and other fluids. It is essential to observe safety notes » page 158, *Engine compartment*.

Note

- The arrangement of the warning lights depends on the model version. The symbols shown in the following functional description are to be found as warning lights in the instrument cluster.

Handbrake

The warning light  comes on if the handbrake is applied. An audible warning is also given if you drive the vehicle for at least 3 seconds at a speed of more than 6 km/h.

The following is displayed in the information display:

Release parking brake!

Brake system





The warning light  illuminates if the brake fluid level is too low or there is a fault in the ABS.

The following is displayed in the information display:

Brake fluid: Owner's manual!

Stop the vehicle, switch off the engine, and check the level of the brake fluid » page 164 » .

WARNING

- If you have to stop for technical reasons, then park the vehicle at a safe distance from the traffic, switch off the engine and activate the hazard warning light system » page 44.
- The following guidelines should be observed when opening the bonnet and checking the brake fluid level » page 158, *Engine compartment*.
- If the warning light  is displayed simultaneously with warning light  » page 22, *Antilock brake system (ABS)* ,  **do not continue your journey!** Seek help from a ŠKODA specialist garage.
- A fault to the braking system can increase the vehicle's braking distance!

Seat belt warning light

The warning light  comes on after the ignition is switched on as a reminder for the driver to fasten the seat belt. The warning light only goes out if the driver has fastened his seat belt.

If the seat belt has not been fastened by the driver, a permanent warning signal sounds at vehicle speeds greater than 20 km/h and simultaneously the warning light  flashes.

If the seat belt is not fastened by the driver during the next 90 seconds, the warning signal is deactivated and the warning light  lights up permanently.

Further information » [page 125, Seat belts](#).

Dynamo



If the warning light lights up  when the engine is running, the vehicle battery is not being charged.

Seek help from a ŠKODA specialist garage. The electrical system requires checking.

! WARNING

If you have to stop for technical reasons, then park the vehicle at a safe distance from the traffic, switch off the engine and activate the hazard warning light system » [page 44](#).

! CAUTION

If the warning light  (cooling system fault) comes on in addition to the warning light  when driving, stop the vehicle immediately and switch the engine off - risk of engine damage!

Open door

The warning light  comes on, if one or several doors are opened.

The warning light comes on even when the ignition is switched off. The warning light lights up for a maximum of 5 minutes.

! WARNING

If you have to stop for technical reasons, then park the vehicle at a safe distance from the traffic, switch off the engine and activate the hazard warning light system » [page 44](#).

Coolant temperature/coolant level



- If the warning light  lights up or flashes, either the coolant temperature is too high or the coolant level is too low.

The following is displayed in the information display:

Check coolant! Owner's manual!

Stop the vehicle, switch off the engine, check the level of the coolant » [page 163](#), and refill the coolant if necessary » [page 163](#).

If the coolant is within the specified range, the increased temperature may be caused by an operating problem at the radiator fan. Check the fuse for the radiator fan, replace if necessary » [page 191, Fuses in the engine compartment](#).



If the warning light  does not go off even though the coolant level is correct and the fuse for the fan is in working order  **do not continue driving!**

Seek help from a ŠKODA specialist garage.

! WARNING

- If you have to stop for technical reasons, then park the vehicle at a safe distance from the traffic, switch off the engine and activate the hazard warning light system » [page 44](#).
- Carefully open the coolant expansion bottle. If the engine is hot, the cooling system is pressurized - risk of scalding! It is therefore best to allow the engine to cool down before removing the cap.
- Do not touch the radiator fan. The radiator fan may switch itself on automatically even if the ignition is off.

Bonnet



The warning light  comes on if the bonnet is unlocked. If the bonnet unlocks while driving, the warning light  lights up and an audible signal sounds.

The warning light comes on even when the ignition is switched off. The warning light lights up for a maximum of 5 minutes.

! WARNING

If you have to stop for technical reasons, then park the vehicle at a safe distance from the traffic, switch off the engine and activate the hazard warning light system » [page 44](#).

Boot lid

The warning light  comes on when the ignition is switched on if the luggage compartment door is open. If the boot lid opens while driving , the warning light lights up and an audible signal sounds.

The warning light comes on even when the ignition is switched off. The warning light lights up for a maximum of 5 minutes.

Engine oil

The warning light lights up red (low oil pressure)

The following is displayed in the information display:

Oil Pressure: Engine off! Owner's manual!

Stop the vehicle, switch off the engine, and check the level of the engine oil » [page 161](#), *Checking the engine oil level*.

Even if the oil level is correct, **do not drive any further** if the warning light is flashing . Also do not leave the engine running at an idling speed.

Seek help from a ŠKODA specialist garage.

The warning light lights up yellow (oil quantity too low)

The following is displayed in the information display:

Check oil level!

Stop the vehicle, switch off the engine, and check the level of the engine oil » [page 161](#).

The warning light will go out if the bonnet is left open for more than 30 seconds. If no engine oil has been replenished, the warning light will come on again after driving about 100 km.

The warning light flashes yellow (engine oil level sensor faulty)

The following is displayed in the information display:

Oil sensor: Workshop!

If the engine oil level sensor is faulty, the warning light flashes  several times and an audible signal sounds when the ignition is turned on.

Seek help from a ŠKODA specialist garage.

! WARNING

If you have to stop for technical reasons, then park the vehicle at a safe distance from the traffic, switch off the engine and activate the hazard warning light system » [page 44](#).

Electromechanical power steering

If the warning light  lights up, this indicates a partial failure of the power steering and the steering forces can be greater. Seek help from a ŠKODA specialist garage.



If the warning light  lights up, this indicates a complete failure of the power steering and the steering assist has failed (significantly higher steering forces). Seek help from a ŠKODA specialist garage.

Further information » [page 92](#).

! WARNING

If you have to stop for technical reasons, then park the vehicle at a safe distance from the traffic, switch off the engine and activate the hazard warning light system » [page 44](#).

i Note

If the vehicle battery has been disconnected and reconnected, the yellow warning light  comes on after switching on the ignition. The warning light should go out after driving a short distance. If the yellow warning light  does not go out after starting the engine again and a short drive, it is necessary to visit a ŠKODA specialist garage.

Traction control system (TCS)

The warning light flashes  to show that the ASR is currently operating.

If the warning light  comes on immediately after starting the engine, the ASR can be switched off for technical reasons. Switch the ignition off and on again. If the warning light does not light up after you switch the engine back on, the ASR is fully functional again.

If the warning light  lights up, there is a fault in the ASR.

The following is displayed in the information display:

Error: traction control (ASR)

Seek help from a ŠKODA specialist garage.

Further information » [page 96](#), *Traction control system (TCS)*.

Note

If the vehicle's battery has been disconnected and reconnected, the warning light  comes on after switching on the ignition. The warning light should go out after driving a short distance.

Electronic Stability Control (ESC) 

The warning light flashes  to show that the ESC is currently operating.

If the warning light  comes on immediately after you start the engine, the ESC might be switched off due to technical reasons. Switch the ignition off and on again. If the warning light does not light up after you switch the engine back on, the ESR is fully functional again.

If the warning light  lights up, there is a fault in the ESC.

The following is displayed in the information display:

Error: Electronic Stability Control (ESC)

Seek help from a ŠKODA specialist garage.

Further information » [page 95](#), *Stabilisation Control (ESC)*.

Note

If the vehicle's battery has been disconnected and reconnected, the warning light  comes on after switching on the ignition. The warning light must go out after driving a short distance.

Antilock brake system (ABS) 

If the warning light  lights up, there is a fault in the ABS.

The following is displayed in the information display:



Error: ABS

The vehicle will only be braked by the normal brake system without the ABS.

Seek help from a ŠKODA specialist garage.

Further information » [page 96](#), *Antilock brake system (ABS)*.

WARNING

- If you have to stop for technical reasons, then park the vehicle at a safe distance from the traffic, switch off the engine and activate the hazard warning light system » [page 44](#).
- If the warning light  is displayed simultaneously with warning light , **do not continue your journey!** Seek help from a ŠKODA specialist garage.
- A fault to the ABS system or the braking system can increase the vehicle's braking distance - risk of accident!

The rear fog light 

The warning light  comes on when the rear fog lights are operating » [page 43](#).

Bulb failure 

The warning light  comes on if a bulb is faulty:
➤ within 2 seconds of the ignition being switched on;
➤ when switching on the defective light bulb.

The following is displayed in the information display:

Check front-right dipped beam!

Exhaust inspection system 

If the warning light  lights up, there is a fault in the exhaust inspection system. The engine control unit allows the vehicle to run in emergency mode.

Seek help from a ŠKODA specialist garage.

Glow plug system (diesel engine)

The warning light  comes on after the ignition has been switched on. The engine can be started immediately after the pre-glow warning light goes out.

There is a fault in the glow plug system if the warning light  **does not** come on at all or **lights up continuously**.

If the warning light  begins to **flash** while driving, a fault exists in the engine control. The engine control unit allows the vehicle to run in emergency mode.

Seek help from a ŠKODA specialist garage.

EPC fault light (petrol engine)

If the warning light  lights up, there is a fault in the engine control. The engine control unit allows the vehicle to run in emergency mode.

Seek help from a ŠKODA specialist garage.



Diesel particulate filter (diesel engine)

The diesel particulate filter separates the soot particles from the exhaust. The soot particles collect in the diesel particulate filter where they are burnt on a regular basis.

If the warning light  lights up, soot has accumulated in the diesel particulate filter.

To clean the diesel particle filter, the vehicle should be driven at an even speed of at least 60 km/h  at engine speeds of 1 800 - 2 500 rpm for at least 15 minutes or until the warning light goes out with the 4th or 5th gear engaged (automatic gearbox: position S) when the traffic situation permits it.

The warning light  only goes out after the diesel particulate filter has been successfully cleaned.

If the filter is not properly cleaned, the warning light  does not go out and the warning light  begins to flash.

The following is displayed in the information display:

Diesel particulate filter Owner's manual!

■ Seek help from a ŠKODA specialist garage.

WARNING

- The diesel particle filter achieves very high temperatures. Therefore do not park in areas where the hot filter can come into direct contact with dry grass or other combustible materials - risk of fire!
- Always adjust your speed to suit weather, road, region and traffic conditions. The recommendations indicated by the warning light must not tempt you to disregard the national regulations for road traffic.

CAUTION

As long as the warning light  lights up, one must take into account an increased fuel consumption and in certain circumstances a power reduction of the engine.

Note

- To assist the combustion process of the soot particles, we recommend that regularly driving over short distances should be avoided.
- Using diesel fuel with an increased sulphur content can considerably reduce the life of the diesel particle filter. A ŠKODA specialist garage will be able to tell you which countries use only diesel fuel with high sulphur content.

Fuel reserve

The warning light  will come on if the fuel level is less than 9 litres.

An audible signal sounds as a warning signal.

The following is displayed in the information display:

Please refuel! Range ... km

Note

The text in the information display goes out only after refuelling and driving a short distance.

Airbag system

If the warning light  lights up, there is a fault in the airbag system.

The following is displayed in the information display:

Error: Airbag

The functionality of the airbag system is monitored electronically even if one of the airbags is switched off.

If a front, side or head airbag or belt tensioner has been switched off using the vehicle system tester:

➤ The warning light  lights up for around 4 seconds after switching on the ignition and then flashes approximately another 12 seconds in 2 second intervals.

The following is displayed in the information display:

Airbag/belt tensioner deactivated!

The following applies if the airbag has been switched off using the key switch in the storage compartment:

➤ The warning light  comes on for 4 seconds after the ignition has been switched on.

➤ Switching off the airbag is indicated by the lighting up of the warning light **AIRBAG OFF (airbag switched off)** in the middle of the dash panel » [page 133](#).

WARNING

If there is a fault, have the airbag system checked immediately by a ŠKODA specialist garage. Otherwise, there is a risk of the airbag not being activated in the event of an accident.

Tyre control display

The warning light  lights up, if there is a substantial drop in inflation pressure in one of the tyres. Check and adjust the pressure in all tyres » [page 170](#).

An audible signal sounds as a warning signal.

If the warning light  lights up, there is a fault in the system.

Seek help from a ŠKODA specialist garage.

Further information » [page 175](#), *Tyre control display*.

Note

If the battery has been disconnected, the warning light  illuminates after the ignition is switched on. The warning light should go out after driving a short distance.

Windscreen washer fluid level

If the windscreen washer fluid level is too low, the warning light  comes on. Top up with liquid » [page 165](#).

The following is displayed in the information display:

Top up wash fluid!

Switching off traction control system (TCS)

The ASR is switched off by pressing the button » [Fig. 96](#) on page 95 and the warning light  illuminates.

The following is displayed in the information display:

Traction control (ASR) deactivated.

Turn signal system

Either the left  or right  warning light flashes depending on the position of the turn signal lever.

If a turn signal light fails, the warning light flashes at twice its normal rate. This does not apply when towing a trailer.

Switching off the hazard warning light system is switched on will cause all of the turn signal lights as well as both warning lights to flash.

Further information » [page 45](#), *Turn signal and main beam lever*.

Fog lights

The warning light  comes on when the fog lights are operating » [page 42](#).

Speed regulating system

The warning light  comes on when the cruise control is operating » [page 99](#). ■

Low beam

The warning light  comes on when low beam is selected » [page 40](#). ■

Selector lever lock

If the warning light  lights up, operate the brake pedal. This is necessary, to be able to move the selector lever from position **P** or **N** » [page 105](#). ■

Main beam

The warning light  comes on when the main beam or headlight flasher are selected » [page 45](#). ■

Unlocking and locking

Vehicle key

Introductory information

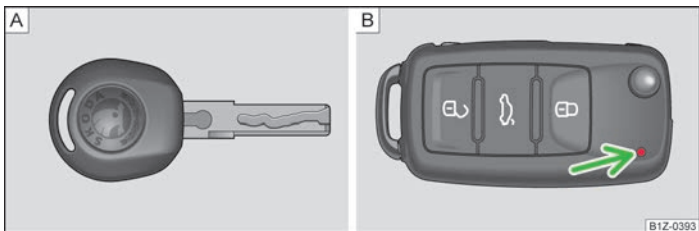

Fig. 8 Key without remote control/key with remote control (remote control key)

Two keys are provided with the vehicle. Depending on the equipment, your vehicle can be equipped with keys without radio remote control » Fig. 8 - A or with radio remote control » Fig. 8 - B.

! WARNING

- Always withdraw the key whenever you leave the vehicle - even if it is only for a short time. This is particularly important if children are left in the vehicle. The children might otherwise start the engine or operate electrical equipment (e.g. power windows) - risk of injury!
- Do not withdraw the ignition key from the ignition lock until the vehicle has come to a stop. The steering lock might otherwise engage unintentionally - risk of accident!

! CAUTION

- Each key contains electronic components; therefore it must be protected against moisture and severe shocks.
- Keep the groove of the keys absolutely clean. Impurities (textile fibres, dust, etc.) have a negative effect on the functionality of the locking cylinder and ignition lock.

i Note

Please approach a ŠKODA Service Partner if you lose a key as they can obtain a new one for you.

Replacing the battery in the remote control key

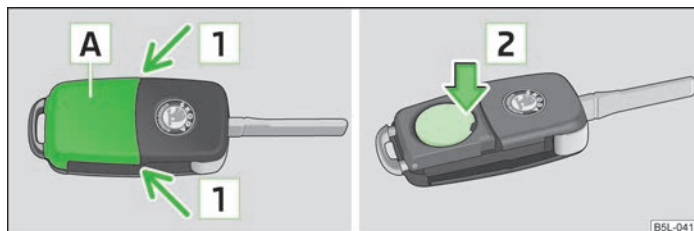

Fig. 9 Remote control key: Remove cover/remove battery

- Each remote control key contains a battery that is located under the cover A » Fig. 9. The battery needs replacing if red warning light » Fig. 8 on page 26 - B does not go on when you press a button on the remote control key. We recommend that you ask a ŠKODA Service Partner to replace the key battery. However, if you would like to replace the discharged battery yourself proceed as follows.
- Flip out the key.
 - Press off the battery cover with your thumb or using a flat screwdriver in the region of arrows 1 » Fig. 9.
 - Remove the discharged battery from the key by pressing the battery downwards in the region of arrow 2.
 - Insert the new battery. Ensure that the "+" symbol on the battery is facing upwards. The correct polarity is shown on the battery cover.
 - Place the battery cover on the key and press it down until it clicks into place. ▶

! CAUTION

- Pay attention to the correct polarity when changing the battery.
- The replacement battery must have the same specification as the original battery.



For the sake of the environment

Dispose of the used battery in accordance with national legal provisions.

i Note

- Please approach a ŠKODA Service Partner if you lose a key as they can obtain a new one for you.
- The system has to be synchronised, if the vehicle cannot be unlocked or locked with the remote control key after replacing the battery » [page 31](#).

Child safety lock



Fig. 10
Child safety locks on the rear doors

The child safety lock prevents the rear door from being opened from the inside. The door can only be opened from the outside.

You can switch the child safety lock on and off using the vehicle key.

Switching on

- Use the vehicle key to turn the slit in the rear door in the direction of the arrow » [Fig. 10](#).

Switching off

- Use the vehicle key to turn the slit to the right in the opposite direction to the arrow.

Central locking system

Introductory information

When using the central locking and unlocking system, **all** the doors and the fuel filler flap are locked or unlocked at the same time (if it was not set differently in the menu item **Settings - Convenience** of the information display). The boot lid is unlocked when opening.

Warning light in the driver's door

After locking the vehicle, the warning light flashes for around 2 seconds in quick succession, afterwards it begins to flash evenly at longer intervals.

If the vehicle is locked and the safe securing system » [page 28](#) is not operating, the warning light in the driver door flashes for about 2 seconds fast, goes out and starts to flash evenly at longer intervals after about 30 seconds.

If the warning light first of all flashes fast for about 2 seconds, afterwards lights up for about 30 seconds without interruption and then flashes slowly, there is a fault in the system of the central locking or in the interior monitor and in the towing protection monitoring » [page 32](#). Seek help from a ŠKODA specialist garage.

Convenience operation of windows

The windows can be opened and closed when unlocking and locking the vehicle » [page 36](#).

Individual settings

Opening a single door

This selection function makes it possible to only unlock the driver's door. The other doors and the fuel filler flap remain locked and are only unlocked after being opened again.

Automatic locking and unlocking

All the doors and the boot lid are locked automatically once the car reaches a speed of about 15 km/h.

If the ignition key is withdrawn, the car is then automatically unlocked again. In addition, it is possible for the driver or front passenger to unlock the car by pressing the central locking button  » [page 29](#).

The doors can be unlocked and opened from the inside by pulling on the opening lever of the respective door. By the first pull on the opening lever, the door is **unlocked**. By the second pull on the opening lever, the door is **opened**.

! WARNING

Locked doors prevent unwanted entry into the vehicle from outside, for example at road crossings. Locked doors do, however, make it more difficult for rescuers to get into the vehicle in an emergency - danger to life!

i Note

- You can have the individual settings activated by a ŠKODA Service Partner or you can activate them yourself with the help of the information display » [page 16, Settings](#).
- In the event of an accident in which the airbags are deployed, the locked doors are automatically unlocked in order to enable rescuers to gain access to the vehicle.
- Only the driver's door can be unlocked or locked using the key if the central locking system fails » [page 28](#). The other doors and the boot lid can be manually locked or unlocked.
 - Emergency locking of the door » [page 32](#).
 - Emergency unlocking of the boot lid » [page 34](#).

Safe securing system

The central locking system is equipped with a **safe securing system**. The door locks are blocked automatically if the vehicle is locked from the outside. The warning light flashes for around 2 seconds in quick succession, afterwards it begins to flash evenly at longer intervals. It is not possible to open the doors with the door handle either from the inside or from the outside. This acts as an effective deterrent for attempts to break into your vehicle.

The safe securing system can be deactivated within 2 seconds by double locking the vehicle.

If the safe securing system is not operating, the warning light in the driver door flashes for about 2 seconds fast, goes out and starts to flash evenly at longer intervals after about 30 seconds.

The safe securing system is activated again the next time the vehicle is unlocked and locked.

If the vehicle is locked and the safe securing system is deactivated, the door can be unlocked and opened from the inside by pulling on the opening lever of the respective door. By the first pull on the opening lever, the door is **unlocked**. By the second pull on the opening lever, the door is **opened**.

! WARNING

If the vehicle is locked from the outside and the safe securing system is activated, there must not be any person in the vehicle as it is then no longer possible to open either a door or a window from the inside. The locked doors make it more difficult for rescuers to get into the vehicle in an emergency - hazard!

i Note

- The anti-theft alarm system is activated when the vehicle is locked even if the safe securing system is deactivated. The interior monitor is however not activated.
- After locking the vehicle, you will be informed that the safe securing system is activated by means of the message **CHECK DEADLOCK** on the instrument cluster display. On vehicles that are equipped with an information display, the following message will appear **Check deadlock! Owner's manual!** appears.

Unlocking the vehicle using the key

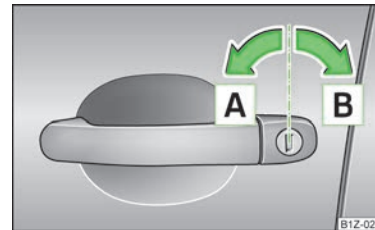

Fig. 11
Turning the key for unlocking
and locking the vehicle

- Turn the key in the locking cylinder of the driver's door in the direction of travel (unlock position) **A** » [Fig. 11](#).
- Pull the door handle and open the door.
- All the doors (only the driver's door on vehicles with anti-theft alarm system) and the fuel filler flap are unlocked.
- The boot lid is then unlocked.
- The switched on interior lights come on over the door contact.
- The safe securing system is deactivated.

- › The windows open while the key is held in the unlock position.
- › The warning light in the driver door stops flashing if the car is not fitted with an anti-theft alarm system » [page 31](#).

i Note

If the vehicle is equipped with an anti-theft alarm system, you must insert the key into the ignition lock and switch the ignition on within 15 seconds after unlocking the door in order to deactivate the anti-theft alarm system. The **alarm is triggered** if the ignition is **not switched on** within 15 seconds.

Locking the vehicle with the key

- › Turn the key in the locking cylinder of the driver's door in the opposite direction of travel (lock position) **[B]** » [Fig. 11](#) on [page 28](#).
- › The doors, the boot lid and the fuel filler flap are locked.
- › The switched on interior lights will switch off over the door contact.
- › The windows and the electric sliding/tilting roof close while the key is held in the lock position.
- › The safe securing system is immediately activated.
- › The warning light in the driver door begins flashing.

i Note

If the driver's door has been opened, the vehicle cannot be locked.

Vehicle locking/unlocking from the inside

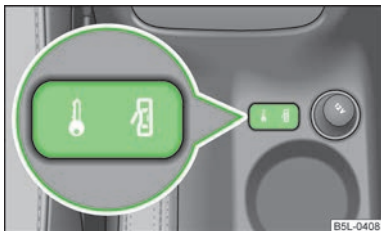

Fig. 12
Centre console: Central locking button

If the vehicle was not locked from the outside, you can also unlock and lock it with the rocker switch » [Fig. 12](#) without the ignition switched on.

Locking all doors and the boot lid

- › Press the button in the area **[A]** » [Fig. 12](#). The symbol **[A]** in the button comes on.

Unlocking all doors and the boot lid

- › Press the button in the area **[B]** » [Fig. 12](#). The symbol **[A]** in the button is no longer illuminated.

The following applies if your vehicle has been locked using the central locking button.

- › It is not possible to open the doors or the boot lid from the outside (safety feature, e.g. when stopping at traffic lights etc.).
- › The doors can be unlocked and opened from the inside by pulling on the opening lever of the respective door. By the first pull on the opening lever, the door is **unlocked**. By the second pull on the opening lever, the door is **opened**.
- › If at least one door has been opened, the vehicle cannot be locked.
- › In the event of an accident in which the airbags are deployed, the locked doors are automatically unlocked from the inside in order to enable rescuers to gain access to the vehicle.

The central locking button can be used to control the convenience opening and closing of the windows » [page 36](#).

! WARNING

The central locking system also operates if the ignition is switched off. Children should never be left unattended in the vehicle since it is difficult to provide assistance from the outside when the doors are locked. Locked doors make it difficult for rescuers to get into the vehicle in an emergency - hazard!

i Note

If the safe securing system is activated » [page 28](#), the door opening lever and the central locking buttons do not operate.

Remote control

Introductory information

You can use the remote control key to:

- › unlock and lock the vehicle,
- › unlocking boot lid;
- › open and close the windows » [page 36](#), *Window convenience operation*.

The transmitter with the battery is housed in the handle of the remote control key. The receiver is located in the interior of the vehicle. The operating range of the remote control key is approx. 30 m. But this range of the remote control can be reduced if the batteries are weak.

The key has a fold-open key bit which can be used for unlocking and locking the car manually and also for starting the engine.

If a lost key is replaced or if the receiver unit has been repaired or replaced, the system must be initialised by a ŠKODA Service Partner. Only then can the remote control key be used again.

i Note

- The remote control is automatically deactivated when the ignition is switched on.
- The operation of the remote control may temporarily be affected by interference from transmitters close to the car and which operate in the same frequency range (e.g. mobile phone, TV transmitter).
- The battery must be replaced if the central locking or anti-theft alarm system does react to the remote control at less than 3 metres away » [page 26](#).
- If the driver door is open, the vehicle cannot be locked using the remote control key.

Locking/unlocking

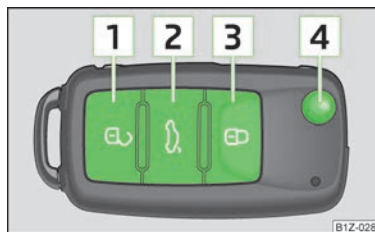

Fig. 13
Remote control key

Unlocking the vehicle

- › Press the button **1** » [Fig. 13](#).

Locking the vehicle

- › Press the button **3** » [Fig. 13](#).

Deactivating the safe securing system

- › Press the button **3** » [Fig. 13](#) twice within 2 seconds. Further information » [page 28](#).

Unlocking the boot lid

- › Press the button **2** » [Fig. 13](#). Further information » [page 33](#), *Open/close*.

Folding out the key bit

- › Press the button **4** » [Fig. 13](#).

Folding in the key bit

- › Press the button **4** » [Fig. 13](#) and fold in the key bit.

Unlocking

The turn signal lights flash twice as confirmation that the vehicle has been unlocked. If the vehicle is unlocked using button **1** » [Fig. 13](#) and none of the doors or the boot lid are opened within the next 30 seconds, the vehicle is automatically locked again and the safe securing system or anti-theft alarm system is reactivated. This function is intended to prevent the car being unlocked unintentionally.

In addition, when the car is unlocked, the electrically adjustable seats and exterior mirrors move into the position assigned to this key. The stored setting of driver seat and exterior mirrors is retrieved. ▶

Locking



The turn signal lights flash once to confirm that the vehicle has been correctly locked.

If the doors or the boot lid remain open after the vehicle has been locked, the turn signal lights do not flash until they have been closed.

WARNING

If the car is locked from the outside and the safe securing system is activated, there must not be any person in the car as it is then not possible to open either a door or a window from the inside. The locked doors make it more difficult for rescuers to get into the vehicle in an emergency - hazard!

Note

- Only operate the remote control when the doors and boot lid are closed and the vehicle is in your line of sight.
- To avoid the car being locked inadvertently once in the car, the lock button  of the remote control must not be pressed before the key is inserted into the ignition lock. Should this happen, press the unlock button  of the remote control. ■

Synchronisation

If the vehicle cannot be unlocked by actuating the remote control system then it is possible that the code in the key and the control unit in the vehicle are no longer synchronised. This can occur when the buttons on the radio-operated key are actuated a number of times outside of the operative range of the equipment or the battery on the remote control was replaced.

This means it is necessary to synchronise the code as follows:

- > press any button on the remote control key;
- > pressing of the button means that the door will unlock with the key within 1 minute. ■

Anti-theft alarm system

Introductory information

The anti-theft alarm system increases the level of protection against people seeking to break into the vehicle. The system triggers audible and visual warning signals if an attempt is made to break into the vehicle.

How is the alarm system activated?

The anti-theft alarm system is activated when the vehicle is locked with the radio remote control or the key in the driver's door. It is activated 30 seconds after locking the door.

How is the alarm system deactivated?

The alarm system is deactivated by pressing the unlock button on the radio remote control. The anti-theft alarm system is reactivated if the vehicle is not opened within 30 seconds after transmitting the radio signal.

The alarm system is also deactivated if you unlock the driver door using the key within 45 seconds of locking the vehicle.

If the vehicle is unlocked by inserting the key into the driver door, the key must be inserted into the ignition lock and the ignition switched on within 15 seconds of unlocking the door to deactivate the alarm system. The **alarm is triggered** if the ignition is **not switched on** within 15 seconds.

When is the alarm triggered?

The following security areas of the locked vehicle are monitored:

- > bonnet;
- > boot lid;
- > doors;
- > ignition lock;
- > Vehicle inclination » [page 32](#);
- > Interior of the vehicle » [page 32](#);
- > A drop in voltage of the on-board power supply;
- > Socket of the factory-fitted towing device.

An alarm is immediately triggered if either of the two battery terminals is disconnected while the anti-theft alarm system is activated.

How is the alarm switched off?

The alarm is switched off by unlocking the vehicle with the radio remote control or switching on the ignition. ▶

i Note

- The working life of the alarm siren is 5 years.
- Before leaving the car, it must be checked that all of the windows, doors and the electric sliding/tilting roof are properly closed to ensure the full functionality of the anti-theft alarm system.
- Coding of the radio remote control and the receiver unit precludes the use of the radio remote control from other vehicles.



Interior monitor and towing protection monitoring



Fig. 14
Button for interior monitor and
towing protection monitoring

The interior monitor detects movements inside the car and then triggers the alarm.

Switching off

- Switch off the ignition.
- Open the driver door.
- Press the button  » Fig. 14 on the centre column on the driver side, the symbol  that lights up in the button changes from red to orange.
- Lock the vehicle within 30 seconds.

The interior monitor and the towing protection monitoring are switched on again automatically the next time the car is locked.

i Note

- Switch off the interior monitor and the towing protection monitoring if there is a possibility of the alarm being triggered by movements from (e.g. children or animals) within the vehicle interior or if the vehicle has to be transported (e.g. by train or ship) or towed.
- The opened glasses storage compartment reduces the effectiveness of the interior monitor. To ensure the full functionality of the interior monitor, the glasses storage compartment must always be closed before locking the vehicle.

Emergency locking of the doors

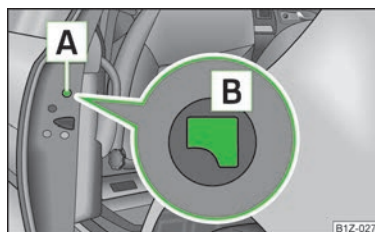

Fig. 15
Rear door: Emergency locking of
the door

An emergency locking mechanism is located on the face side of the doors which have no locking cylinder, it is only visible after opening the door.

- Remove the panel **A** » Fig. 15.
- Insert the key into the opening under the panel and press the stopping lever **B** as far as the stop toward the inside.
- Replace the cover.

After closing the door, it no longer be opened from the outside. The door can be unlocked from the inside by pulling on the door handle again, and then opened from the outside.

Boot lid

Introduction

This chapter contains information on the following subjects:

Open/close	33
Automatic locking	33
Emergency unlocking	34

! WARNING

- Ensure that the lock is properly engaged after closing the boot lid. Otherwise, the boot lid might open suddenly when driving even if the boot lid lock was closed - risk of accident!
- Never drive with the boot lid fully opened or slightly ajar otherwise exhaust gases may get into the interior of the vehicle - risk of poisoning!
- Do not press on the rear window when closing the boot lid, it could crack - risk of injury!

i Note

- After closing the boot lid, it is automatically locked within 1 second and the anti-theft alarm system is activated. This applies only if the vehicle was locked before closing the boot lid.
- The function of the handle above the licence plate is deactivated when starting off or at a speed of 5 km/hour or more for vehicles with central locking. The function of the handle is activated again when the vehicle has stopped and a door is opened.

Open/close



Fig. 16
Handle of boot lid

First read and observe the introductory information and safety warnings on page 33.

After unlocking the vehicle, you can open the lid by pushing the handle located above the licence plate.

Opening

➤ Push the handle and lift the boot lid in the direction of the arrow » Fig. 16.

Closing

➤ Pull down the boot lid and close it with a slight swing.

A handle which makes the closing easier is located on the inner panelling of the boot lid.

Automatic locking

First read and observe the introductory information and safety warnings on page 33.

If the vehicle was locked with the button on the remote control key before the boot lid was closed, the lid is automatically locked as soon as it is closed.

The delayed automatic locking function of the boot lid can be activated on your vehicle. The following applies following activation of this function: If the boot lid was locked with the button on the remote control key 2 » page 30, then it is possible to open the lid within a limited period of it being closed.

If you wish, a ŠKODA Service Partner can activate or deactivate the delayed automatic locking of the boot lid. The Service Partner will also provide any further information that is required.

There is a risk of unwanted entry into the vehicle before the boot lid is locked automatically. Always lock the vehicle using the button  on the remote control or with the key if no remote control is available » [page 29](#).

Emergency unlocking

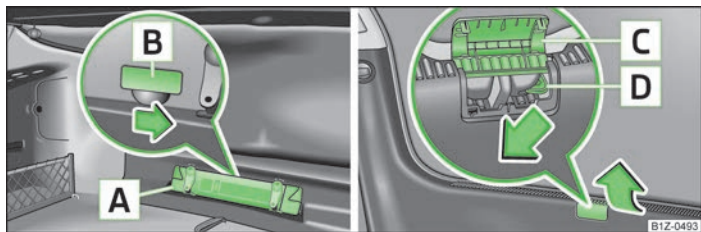



Fig. 17 Emergency unlocking of the boot lid

 **First read and observe the introductory information and safety warnings  on page 33.**

The boot lid can be unlocked manually if there is a fault in the central locking system.

Unlocking

- Fold the rear seat backrest forward » [page 59](#).
- Remove the warning triangle **A** » [Fig. 17](#).
- Remove the panel **B**; the cable for lever for opening the boot lid is located in the opening underneath the panel.
- Press on the level in the direction of arrow » [Fig. 17](#), the boot lid is unlocked.
- Open the boot lid.

Unlocking (Combi)

- Fold the rear seat backrest forward » [page 59](#).
- Pull up the panel **C** » [Fig. 17](#).
- Use a screwdriver or similar to press the lever **D** as far as the stop in the direction of the arrow; the boot lid is unlocked.
- Open the boot lid.

Electric power windows

Introduction

This chapter contains information on the following subjects:

Window open/close	_____	35
Window in the front passenger door and the rear doors open/close	_____	36
Force limiter of the power windows	_____	36
Window convenience operation	_____	36
Operational faults	_____	37

WARNING

- If the vehicle is locked from the outside, do not leave anybody in the vehicle as it is not possible to open the windows from the inside in the event of an emergency.
- The system is fitted with a force limiter » [page 36](#). If there is an obstacle, the closing process is stopped and the window goes down by several centimetres. The windows should nevertheless be closed carefully! Otherwise these can cause severe crushing injuries!
- It is recommended to deactivate the electrically operated power windows in the rear doors (safety pushbutton) **S** » [Fig. 18](#) on page 35 when children are being transported on the rear seats.

CAUTION

- Keep the windows clean to ensure the correct functionality of the electric windows.
- In the event that the windows are frozen, first of all eliminate the ice » [page 151](#), *De-icing windows and exterior mirrors* and only then operate the power windows otherwise the power window mechanism could be damaged.
- When leaving the locked vehicle make sure that the windows are closed at all times.

i Note

- After switching the ignition off, it is still possible to open or close the windows for approx. 10 minutes. The power windows are only switched off completely once the driver or front passenger door are opened.
- When driving always use the existing heating, air conditioning and ventilation system for ventilating the interior of the vehicle. If the windows are opened, dust as well as other dirt can get into the vehicle and in addition the wind noise is more at certain speeds.
- At high speeds, you should keep the windows closed to prevent unnecessarily high fuel consumption.
- The convenience opening of the windows by means of the key in the driver's lock is only possible within 45 seconds of deactivating or activating the alarm system.

Window open/close

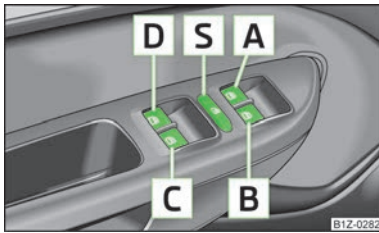

Fig. 18
Buttons on the driver's door



First read and observe the introductory information and safety warnings **i** on page 34.

The power windows operate only when ignition is switched on.

Opening

- A window is opened by pressing lightly on the respective button in the door. The opening process stops when one releases the button.
- Additionally, the window can be opened automatically (fully open) by pressing the button to the stop. Renewed pressing of the button causes the window to stop immediately.

Closing

- A window is closed through pulling lightly on the respective button in the door. The closing process stops when one releases the button.

- Additionally, the window can be closed automatically (fully closed) by pulling the button to the stop. Renewed pulling of the button causes the window to stop immediately.

The buttons for the individual windows are located in the armrest of the driver's door » Fig. 18, front passenger seat and in the rear doors » Fig. 19 on page 36.

Buttons of the power windows

- A** Button for power window of the driver's door
- B** Button for power window of the front passenger door
- C** Button for power window of the rear right door
- D** Button for power window at the rear left door
- S** Safety pushbutton

Safety pushbutton

The buttons for power windows in the rear doors can be deactivated by pressing the safety pushbutton **S** » Fig. 18. The buttons for the power windows in rear doors are activated again by pressing the safety pushbutton **S** again.

If the buttons for the rear doors are deactivated, the warning light  in the safety switch **S** lights up.

i Note

The window lift mechanism is equipped with protection against overheating. Repeated opening and closing of the window can cause this mechanism to overheat. If this happens, it will not be possible to operate the window for a short time. You will be able to operate the window again as soon as the overheating protection has cooled down.

Window in the front passenger door and the rear doors open/close



Fig. 19
Button arrangement in the front passenger door

 First read and observe the introductory information and safety warnings  on page 34.

A button for the relevant window is provided in these doors.

Opening

- Lightly press the appropriate button **down** and hold it until the window has moved into the desired position.
- Additionally, the window can be opened automatically (fully open) by pressing the button **down** to the stop. Renewed pressing of the button causes the window to stop immediately.

Closing

- Lightly press the appropriate button **up** and hold it until the window has moved into the desired position.
- Additionally, the window can be closed automatically (fully closed) by pulling the button **upwards** to the stop. Renewed pressing of the button causes the window to stop immediately.

Force limiter of the power windows

 First read and observe the introductory information and safety warnings  on page 34.

The electrically operated power windows are fitted with a force limiter. It reduces the risk of bruises or injuries when closing the windows.

If there is an obstacle, the closing process is stopped and the window goes down by several centimetres.

If the obstacle prevents the window from being closed during the next 10 seconds, the closing process is interrupted once again and the window goes down by several centimetres.

If you attempt to close the window again within 10 seconds of the window being moved down for the second time, even though the obstacle was not yet been removed, the closing process is only stopped. During this time it is not possible to automatically close the window. The force limiter is still switched on.

The force limiter is only switched off if you attempt to close the window again within the next 10 seconds - **the window will now close with full force!**



If you wait longer than 10 seconds, the force limiter is switched on again. ■

Window convenience operation



 First read and observe the introductory information and safety warnings  on page 34.

The electrically powered windows can be opened and closed as follows when unlocking and locking the vehicle.

Opening

- Press and hold the unlock button  on the remote control key.
- Hold the key in the driver's lock in the unlock position.
- Press and hold the central locking button in the area of the symbol .

Closing

- Press and hold the lock button  on the remote control key.
- Hold the key in the driver's lock in the lock position.
- Press and hold the central locking button in the area of the symbol .

You can interrupt the opening or closing process for the windows immediately by releasing the key or the lock button. ■

Operational faults



First read and observe the introductory information and safety warnings **!** on page 34.

Electrically operated power windows do not operate

If the battery has been disconnected and then reconnected while the window was opened, the electrically operated power windows do not operate. The system must be activated. Proceed as follows in order to re-establish the function:

- > switch on the ignition;
- > pull the top edge of the button in the driver's door to close the window;
- > release the button;
- > pull the relevant button upwards again for approx. 3 seconds.

Operation in winter

In the winter, ice accumulating on the surface of the window may cause there to be more resistance when closing the window. The window will stop and move back several centimetres.

It is necessary to deactivate the force limiter to close the window » page 36.

Electric sliding/tilting roof

Introductory information

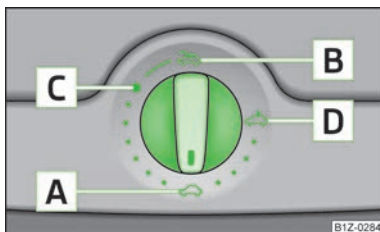

Fig. 20
Control dial for the power sliding/tilting roof

The sliding/tilting roof is operated by means of the control dial » Fig. 20 and only functions when the ignition is switched on. The control dial has several positions.

The sliding/tilting roof can still be opened, closed and tilted for approx. 10 minutes after switching the ignition off. However, as soon as one of the front doors is opened it is no longer possible to operate the sliding/tilting roof.

i Note

If the battery has been disconnected and reconnected, it is possible that the sliding/tilting roof does not close fully. This is why the rotary switch must be set to the switch position **A** » Fig. 20 and pressed forward for about 10 seconds.

Using the system

Comfort position

- > Turn the switch to position **C** » Fig. 20 on page 37.

Opening fully

- > Turn the switch to position **B** » Fig. 20 on page 37 and hold it in this position (spring-tensioned position).

Tilting roof

- > Turn the switch to position **D** » Fig. 20 on page 37.

Closing

- > Turn the switch to position **A** » Fig. 20 on page 37.

Force limiter

The sliding/tilting roof is fitted with a force limiter. If an obstacle (e.g. ice) prevents closing, the sliding/tilting roof stops and opens completely. The sliding/tilting roof can be closed completely without the force limiter by turning the switch into position **A** » Fig. 20 on page 37 at the front for as long as it takes for the sliding/tilting roof to close completely » **!**

When the sliding/tilting roof is in the comfort position, the intensity of the wind noise is much less.

The sun screen is also opened automatically when the roof slides open.

! WARNING



Close the sliding/tilting roof carefully - risk of injury!

! CAUTION

During the winter it may be necessary to remove any ice and snow in the vicinity of the sliding/tilting roof before opening it to prevent any damage to the opening mechanism and seal.

Convenience operation

An open sliding/tilting roof can also be closed from the outside.

- Press and hold the lock button  on the remote control key or keep the key in the lock cylinder of the driver's door in the locked position » .

The closing operation stops immediately when you release the key or the lock button.

! WARNING

Close the sliding/tilting roof carefully - risk of injury! The force limiter does not operate with the convenience closing.

Emergency operation

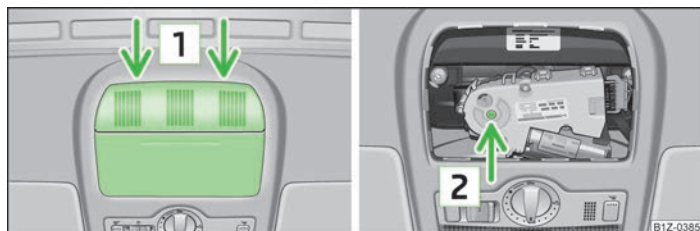





Fig. 21 Point for positioning screwdriver/opening for positioning the key

The sliding/tilting roof can be closed or opened manually if the system is faulty. The emergency operation of the sliding roof is located underneath the glasses storage box  » page 73, *Glasses storage box*.

- Open the glasses storage box.
- Carefully insert an approximately 5 mm wide screwdriver into the slot in the positions shown by the arrows  » Fig. 21.

- Carefully fold the glasses storage box downwards by gently pressing down and turning the screwdriver.
- Insert an Allen key, SW 4, up to the stop into the opening  and close or open the sliding/tilting roof.
- Reinstall the glasses storage box by first inserting the plastic plugs and then pushing the entire part upwards.

Have the fault rectified by a ŠKODA specialist garage.

i Note



It is necessary after each emergency operation (using the Allen key) to move the sliding/tilting roof into the basic position. This is why the rotary switch must be set to the switch position  » Fig. 20 on page 37 and pressed forward for about 10 seconds.

Lights and visibility

Lights

Introduction

This chapter contains information on the following subjects:

Switching lights on and off _____	40
DAY LIGHT function (Daylight driving light) _____	40
Automatic driving lamp control _____	40
Cornering lights _____	41
Parking light _____	41
COMING HOME/LEAVING HOME function _____	41
Tourist light _____	42
Fog lights _____	42
Fog lights with the function CORNER _____	42
Rear fog light _____	43
Instrument lighting  _____	43
Headlight beam adjustment  _____	44
Switches for the hazard warning light system _____	44
Turn signal and main beam lever _____	45

On models fitted with **right-hand steering** the position of certain switches differs from that shown in » Fig. 22 on page 40. The symbols which mark the switch positions are identical, however.

The low beam continues to shine while the ignition is switched on and the light switch is in the position  or **AUTO**. After switching off the ignition, the low beam is switched off automatically and only the side lights come on. The side lights also go out after the ignition key is removed.

WARNING

- Never drive with only the side lights on! The side lights are not bright enough to light up the road sufficiently in front of you or to be seen by other oncoming traffic. Therefore always switch on the low beam when it is dark or if visibility is poor.
- The automatic driving lamp control **AUTO** only operates as a support and does not release the driver from his responsibility to check the light and, if necessary, to switch on the light depending on the light conditions. The light sensor cannot, for example, detect rain or snow. Under these conditions we recommend switching on the low beam or fog lights!

CAUTION

- The activation of the lights should only be undertaken in accordance with national legal requirements.
- The driver is always responsible for the correct settings and use of the lights.

Note

- If the light switch is in the position , the ignition key is removed and the driver's door is open, an audible warning signal will sound. The audible warning signal is switched off by means of the door contact when the driver's door is closed (ignition off), however, the side lights remain on to illuminate the parked vehicle if necessary.
- If there is a fault in the light switch, the low beam comes on automatically.
- In the event of cool or humid weather conditions, the headlights can be misted up from inside. The temperature difference between interior and external area of the headlight lenses is decisive. When the driving lights are switched on, the light outlet surfaces are free from mist after a short period, although the headlight lenses may still be misted up in the peripheral areas. It also concerns reverse light and turn signal lights. This mist has no influence on the life of the lighting system. ■

Switching lights on and off



Fig. 22
Dash panel: Light switch

 First read and observe the introductory information and safety warnings  on page 39.

Switching on the parking light

➤ Turn the light switch » Fig. 22 to position .

Switching on the low beam and main beam

➤ Turn the light switch to position 
➤ Push the main beam lever slightly forward in the spring-tensioned position to switch on the main beam » Fig. 28 on page 45.

Switching off lights (except daytime running lights)

➤ Turn the light switch to position 0.

DAY LIGHT function (Daylight driving light)

 First read and observe the introductory information and safety warnings  on page 39.

Switching on daytime running lights

➤ Turn the ignition on and turn the light switch to position 0 or **AUTO**. **AUTO**.

Deactivating the daytime running lights

➤ Pull the turn signal light lever towards the steering wheel within 3 seconds of switching on the ignition and at the same time, slide it downwards and hold it in this position for at least 3 seconds.

Activating the daytime running lights

➤ Pull the turn signal light lever towards the steering wheel within 3 seconds of switching on the ignition and at the same time, slide it upwards and hold it in this position for at least 3 seconds.

On vehicles with an information display, the daytime running lights can also be activated or deactivated via the menu:

- **Settings**
 - **Lights & Vision**

On vehicles with separate lights for daylight driving lights in the fog lights or in the front bumper, the parking lights and the licence plate light do not come on when activating the function daylight driving lights (neither front nor rear).



If the vehicle is not equipped with separate lights for daylight driving lights, the combination of the low beam, the parking lights (front and rear) including the licence plate light is used as daylight driving lights.

When the daylight driving lights are switched on, the illumination of the instrument cluster is switched off, however, it is switched on in the position **AUTO** when it is dark and the low beam shines with full brightness (100 % of the performance).

Automatic driving lamp control



Fig. 23
Dash panel: Light switch

 First read and observe the introductory information and safety warnings  on page 39.

Switching on

➤ Turn the light switch » Fig. 23 to position **AUTO**.

Switching off

➤ Turn the light switch to the position 0,  or .

If the light switch is in the position **AUTO**, the symbol illuminates when the ignition is switched on **AUTO** next to the light switch. If the low beam is activated with the light sensor, the symbol  illuminates additionally next to the light switch.

If the light comes on automatically, the side lights and low beam as well as licence plate light light up at the same time.

If the automatic driving lamp control is switched on, the light is regulated with the light sensor in the rear mirror holder. If the light intensity drops below the set value, e.g. when driving during the day into a tunnel, the low beam and the side lights as well as the licence plate light come on automatically. If the light intensity increases again, the lights switch off automatically.



Rain lights

If the windscreen wiper is switched on in rain sensor mode for longer than 10 seconds or in permanent wipe mode (position 2 or 3) [» page 49, Activating the windscreen wipers and washers](#) for longer than 15 seconds, the side lights and low beam are switched on automatically. The light switches off if the windscreen wiper is in operation rain sensor for more than around 4 minutes or is not switched on in the operation permanent wipe.

Note

Do not affix any stickers in front of the light sensor, so that its functionality is not impaired or disabled.

Cornering lights

 First read and observe the introductory information and safety warnings  on page 39.

The cornering lights are used to illuminate the curves by means of the cone of light swivelling together with the front headlight with Xenon lights. This function is active when the speed of the car increases to more than 10 km/h.

The swivelling function of the headlights can be switched off/on via the menu point **Assistants** in the main menu of the information display [» page 15](#).

WARNING

If the cornering lights are defective, the headlights are automatically lowered to the emergency position, which prevents a possible dazzling of oncoming traffic. Thus the illuminated length of the road is shortened. Drive carefully and visit a ŠKODA specialist garage as soon as possible.

Parking light

 First read and observe the introductory information and safety warnings  on page 39.

Parking light

- Switch off the ignition.
- Pull the turn signal light lever [» Fig. 28](#) on page 45 upwards or downwards - the side light on the right or left side of the vehicle is switched.

Parking light on both sides

- Turn the light switch into the position  and lock the vehicle.

Note

- The parking light  can only be activated if the ignition is switched off.
- If the right or left turn signal light has been switched on and the ignition is switched off, the parking light is not automatically switched on.

COMING HOME/LEAVING HOME function

 First read and observe the introductory information and safety warnings  on page 39.

When it is dark, this function makes it possible to switch on the lights for a short time after leaving the vehicle or when approaching the vehicle.

Switching on the COMING HOME function

- The light switch is in the position automatic driving lamp control **AUTO**.
- Switch off the ignition.
- The light switches on after the driver's door is opened.

Switching on the LEAVING HOME function

- After leaving the vehicle, the light switch is in the position automatic driving lamp control **AUTO**.

➤ Unlock the vehicle with the radio remote control and the light is switched on.
Depending on the equipment fitted the COMING HOME/LEAVING HOME function switches on the following lights:

- Parking lights;
- Low beam;
- Entry lighting in the exterior mirrors;
- Licence plate light.

The COMING HOME/LEAVING HOME function is controlled with the light sensor in the mount of the interior rear mirror. If the light intensity is higher than the set value of the light sensor, the light is not switched on after opening the driver's door or unlocking the vehicle with the radio remote control.

Switching off the COMING HOME function

The light goes out 10 seconds after closing all of the doors and the boot lid.

If a door or the boot lid remains open, the light goes out after 60 seconds.

Switching off the LEAVING HOME function

The light goes out 10 seconds after unlocking the vehicle with the radio remote control, switching on the ignition or locking the vehicle.

If no door is opened, the vehicle is locked automatically after 30 seconds.

i Note

- If the COMING HOME/LEAVING HOME function is switched on constantly, the battery will be heavily discharged particularly over short distances.
- The illumination period for the COMING HOME/LEAVING HOME function can be changed by means of the information display.

Tourist light

 First read and observe the introductory information and safety warnings **i** on page 39.

This mode makes it possible to drive in countries with opposing traffic system, driving on the left/right, without dazzling the oncoming vehicles. When the mode tourist light is active, the side to side swivel of the headlights is deactivated.

The mode tourist light is activated/deactivated via the information display in the menu:

- Settings
- Lights & Vision
 - Travel mode
 - Off
 - Switched on

Fog lights



Fig. 24
Dash panel: Light switch

 First read and observe the introductory information and safety warnings **i** on page 39.

Switching on

- First of all, turn the light switch to position $\gg\ll$ or \mathbb{D} » Fig. 24.
- Pull the light switch to position **1**.

The warning light \mathbb{D} lights up in the instrument cluster when the fog lights are switched on » page 18.

Fog lights with the function CORNER

 First read and observe the introductory information and safety warnings **i** on page 39.

The fog lights with the function CORNER are designed to improve the illumination of the surrounding area near the vehicle when turning, parking, etc.

The fog lights with the function CORNER are adjusted according to the steering angle or after switching on the turn signal light¹⁾ in the following circumstances:

- the vehicle is stationary and the engine is running or it moves with a speed of maximum 40 km/h;
- the daytime running lights are not switched on;
- the low beam is switched on or the light switch is in the position **AUTO** and the intensity of the ambient light causes the low beam to be switched on;
- the fog lights are not switched on;
- no reverse gear is engaged.

i Note



If the reverse gear is engaged during the active function CORNER, both fog lights illuminate.

Rear fog light

 First read and observe the introductory information and safety warnings **i** on page 39.

Switching on

- First of all, turn the light switch to position  or  » Fig. 24 on page 42.
- Pull the light switch to position .

If the vehicle is not fitted with fog lights » page 42, the rear fog light is switched on by turning the light switch to the position  or  and is pulled out directly to the position . This switch does not have two positions, but only one position.

The warning light  lights up in the instrument cluster when the rear fog light is switched on » page 18.

Only the rear fog light on the trailer lights up if the vehicle has a factory-fitted towing device or a towing device from ŠKODA original accessories and it is driven with a trailer and the rear fog light switched on.

The rear fog light is located in the rear light array on the driver's side.

Instrument lighting



Fig. 25
Dash panel: Instrument lighting



First read and observe the introductory information and safety warnings **i** on page 39.

- Switch on the light.
- Turn the control dial » Fig. 25 to the desired intensity of the instrument lighting.

The illumination intensity of the Information display » page 15 is set automatically. It is only possible to adjust the instrument lighting with the control dial if the light intensity drops below the set value of the light sensor.

¹⁾ If both switch on versions are conflicting, for example if the steering wheel is turned to the left and the right turn signal light is switched on, the turn signal light has the higher priority.

Headlight beam adjustment







Fig. 26
Dash panel: Lights and visibility

 First read and observe the introductory information and safety warnings  on page 39.

Turn the control dial » Fig. 26 to the desired width of illumination.

Settings

The positions correspond approximately to the following car load.

-  Front seats occupied, boot empty.
-  All seats occupied, boot empty.
-  All seats occupied, boot loaded.
-  Driver seat occupied, boot loaded.

CAUTION

Always adjust the headlight range adjustment in such a way that:

- it does not dazzle other road users, especially oncoming traffic;
- and the range is sufficient for safe driving.



Note

- We recommend you adjust the headlight beam when the low beam is switched on.
- Headlights fitted with Xenon bulbs adapt automatically to the load and driving state of the vehicle (e.g. accelerating, braking) when the ignition is switched on and when driving. Vehicles which are equipped with Xenon bulbs do not have a manual headlight range adjustment control.

Switches for the hazard warning light system



Fig. 27
Dash panel: Switch for hazard warning lights

 First read and observe the introductory information and safety warnings  on page 39.

➤ Press switch  » Fig. 27 to switch the hazard warning light system on or off.

All the turn signal lights on the vehicle flash at the same time when the hazard warning light system is switched on. The warning light for the turn signals and the warning light in the switch also flash at the same time. The hazard warning light system can also be operated if the ignition is switched off.

The hazard warning light system is switched on automatically if an airbag is deployed in the event of an accident.

Note

The hazard warning light system must be switched on if, for example:

- you encounter a traffic congestion;
- your vehicle breaks down or an emergency situation occurs.

Turn signal and main beam lever

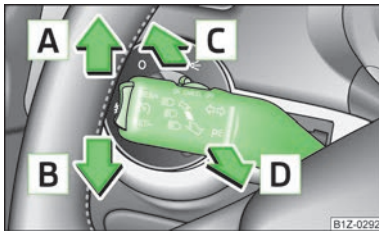

Fig. 28
Turn signal and main beam lever



First read and observe the introductory information and safety warnings **!** on page 39.

The parking light and headlight flasher are also operated with the turn signal and main beam lever.

Right \rightarrow and left \leftarrow turn signal light

- Push the lever upwards **A** » Fig. 28 or downwards **B**.
- If you only wish to flash three times (the "convenience turn signal"), briefly push the lever to the upper or lower pressure point and release again. This feature can be activated/deactivated via the information display » page 15.
- Turn signal for changing lanes - to only flash briefly, move the lever up or down to the pressure point and hold it in this position.

Main beam D

- Switch on the low beam.
- Push the lever away from the steering wheel in the direction of arrow **C** (spring-tensioned position).
- The main beam is switched off by pulling the lever towards the steering wheel (spring-tensioned position) in the direction of arrow **D**.

Headlight flasher D

- Pull the lever towards the steering wheel (spring-tensioned position) in the direction of arrow **D** - the main beam and warning light D in the instrument cluster come on.

Parking light P

Description of the operation » page 41

! CAUTION

Only use the main beam or the headlight flasher if other road users will not be dazzled.

i Note

- The **turn signal system** only operates when the ignition is switched on. The corresponding warning light \leftarrow or \rightarrow in the instrument cluster also flashes.
- The turn signal is automatically cancelled after negotiating a curve.
- The warning light flashes at twice its normal rate if a bulb for the turn signal light fails.

Interior light

Interior lighting - version 1

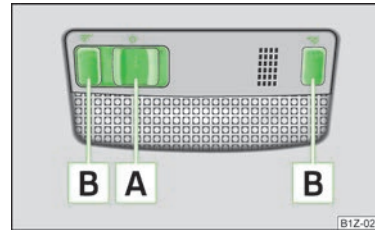

Fig. 29
Interior lighting - version 1

Switching on

- Press switch **A** » Fig. 29 towards the edge of the light, the symbol ☞ appears.

Switching off

- Press the switch **A** » Fig. 29 in the middle position **O**.

Operating with the door contact switch

- Press switch **A** » Fig. 29 towards the middle of the light, the symbol ☞ appears.

Reading lights

- Press switch **B** » Fig. 29 to switch the reading lights on or off.

If operating lights with the door contact switch is enabled (switch **A** is in position ) , the light will come on when:

- the vehicle is unlocked;
- one of the doors is opened;
- or the ignition key is removed.

If operating lights with the door contact switch is enabled (switch **A** is in position ) , the light will turn off when:

- the vehicle is locked;
- the ignition is switched on;
- about 30 seconds after all the doors have been closed.

If a door remains open, or if the switch **A** is in the position , the interior light goes out after 10 minutes to prevent the battery from discharging.

i Note

We recommend having these bulbs replaced by a ŠKODA specialist garage.

Interior lighting - version 2



Fig. 30
Interior lighting - version 2

Switching on

- Press the switch into position  » Fig. 30.

Switching off

- Press the switch into position **O** » Fig. 30.

Operating with the door contact switch

- Press the switch into position  » Fig. 30.

The same principles apply for interior lighting version 2 as for » page 45, *Interior lighting - version 1*.

Illuminated storage compartment on front passenger side

- When opening the flap of the storage compartment on the front passenger side the lighting in the storage compartment comes on.
- The light switches on automatically when the parking light is switched on and goes out when the flap is closed.

Front door warning light



Fig. 31
Front door: Warning light

The warning light is located in the lower door trim panel » Fig. 31.

The warning light goes on every time the door is opened. The light goes out about 10 minutes after opening the door in order to avoid discharging the battery of the vehicle.

There is a reflector installed on some vehicles instead of the warning light.

Entry lighting

The lighting is positioned on the bottom edge of the exterior mirror.

The light beam is directed towards the entry area of the front door.

The light comes on after the doors have been locked or on opening the boot lid. The light goes out after switching on the ignition or within 30 seconds of closing all of the doors and the boot lid.

If a door or the boot lid remains open, the light goes out within 2 minutes if the ignition is switched off.

! WARNING

If the entry light is on, do not touch its cover - risk of burns!

Boot light

The light comes on automatically when the boot lid is opened. If the lid remains open for more than about 10 minutes, the boot light switches off automatically.

Visibility

Rear window heater



Fig. 32
Switch for rear window heater

> The rear window heater is switched on or off by pressing the switch  » Fig. 32 the warning light in the switch comes on or goes out.

The rear window heater only operates when the engine is running.

The rear window heater **switches off** automatically after 10 minutes.



For the sake of the environment

The heating should be switched off as soon as the window is de-iced or free from mist. The reduced current consumption will have a favourable effect on fuel economy » page 142, *Saving electricity*.

i Note

- If the on-board voltage drops, the rear window heater switches off automatically, in order to provide sufficient electrical energy for the engine control » page 169, *Automatic load deactivation*.
- The position and shape of the switch may vary according to the model.

Sun visors

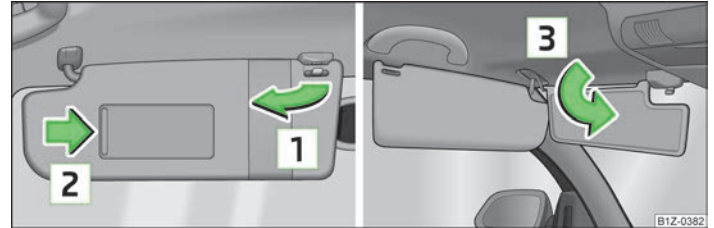





Fig. 33 Sun visor/double sun visor

The sun visor for the driver or front passenger can be pulled out of the fixture and swivelled towards the door in the direction of the arrow  » Fig. 33.

The vanity mirrors in the sun visors are provided with covers. Push the cover in the direction of the arrow .

On vehicles that are equipped with a double sun visor, the auxiliary visor can be unfolded in the direction of the arrow  after swivelling the sun visor towards the door.

! WARNING

The sun visors must not be swivelled towards the side windows in the deployment area of the head airbags if any objects, such as ball-point pens, etc. are attached to them. This might result in injuries to the occupants if the head airbag is deployed.

Sun screen

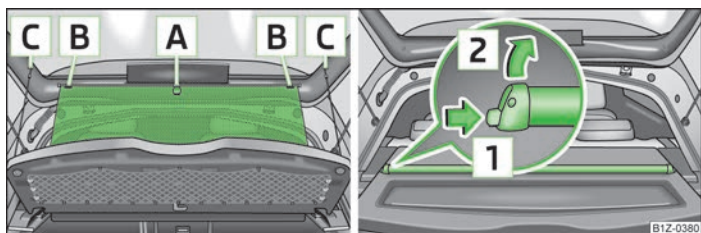

Fig. 34 Sun screen: unroll/remove

The sun screen is located in a housing on the luggage compartment cover. If required, you can remove the housing with the sun screen from the luggage compartment cover.

Pulling out

- Remove the sun screen using the loop **A** and hang it from brackets **B** » Fig. 34.

Folding

- Remove the sun screen from the brackets **B** » Fig. 34 and hold it on the loop **A** so that it can slowly roll up into the housing on the luggage compartment cover without being damaged.

Removing

- Unhook the support straps **C** from the boot cover » Fig. 34.
- Roll up the sun screen again into the housing on the luggage compartment cover.
- Press the locking button in the direction of arrow **1** and take out the sun screen in the direction of arrow **2**.

Windscreen wipers and washers

Introduction

This chapter contains information on the following subjects:

Activating the windscreen wipers and washers	49
Automatic rear window wiper (Combi)	50
Headlight cleaning system	50
Replacing the windscreen wiper blades	51
Replacing the rear window wiper blade	51

The windscreen wipers and the wash system only operate if the ignition is switched on and the bonnet is closed¹⁾.

If the intermittent wipe is switched on, the intervals are also controlled depending on speed.

The rain sensor automatically regulates the break between the individual wiper strokes depending on the intensity of the rain.

The rear window is wiped once if the windscreen wipers are on when reverse gear is selected.

After the windscreen wiper switches off each time or the ignition switches off for the third time, the position of the windscreen wiper changes, this counteracts an early fatigue of the wiper rubbers.

Top up with windscreen wiper fluid » page 165.

! WARNING

- Properly maintained windscreen wiper blades are essential for clear visibility and safe driving » page 51.
- Do not use the windscreen washer system at low temperatures, without heating the windscreen beforehand. Otherwise the window cleaner could freeze on the windscreen and restrict the view to the front.
- The rain sensor only operates as a support. The driver is not released from the responsibility to set the function of the windscreen wipers manually depending on the visibility conditions.

¹⁾ On vehicles which do not have a contact switch for the bonnet, the windshield wiper and wash system operates also when the bonnet is opened.

! CAUTION

- In cold temperatures and during the winter, check before the journey or before switching on the ignition that the wiper blades are not frozen to the windscreen. If the windscreen wipers are switched on when the blades are frozen to the windscreen, this may damage both the blades and windscreen wiper motor!
- If the ignition is switched off while the windscreen wipers are switched on, the windscreen wipers will continue wiping in the same mode after the ignition is turned back on. The windscreen wipers could freeze up in cold temperatures between the time the ignition was turned off and when it was turned back on again.
- Carefully detach frozen wiper blades from the front or rear window.
- Remove snow and ice from the windscreen wipers before driving.
- If the windscreen wipers are handled carelessly, there is a risk of damage to the windscreen.
- Replace the windscreen wiper blades once or twice a year for safety reasons. These can be purchased from a ŠKODA Service Partner.
- The ignition must not be switched on if the front windscreen wiper arms are folded out. The wiper blades would move back into their rest position and while doing so damage the paintwork of the bonnet.

i Note

- If the slower [2] » Fig. 35 on page 49 or the faster [3] wiper setting is switched on and the vehicle speed decreases to below 4 km/h, the lower wiper step is switched on automatically. At a speed increase of more than 8 km/h the previous wiper setting is established again.
- If there is an obstacle on the windscreen, the wiper will try to push away the obstacle. If the obstacle continues to block the wiper, the wiper stops automatically after 5 attempts to eliminate the obstacle, in order to avoid a damage to the wiper. Remove the obstacle and switch the wiper on again.
- The windscreen washer nozzles for the windscreen are heated when the engine is running and the outside temperature is less than approx. +10 °C.
- The content of the windscreen washer fluid reservoir is 3 litres. On vehicles fitted with the headlight cleaning system, the volume is 5,5 litres. On vehicles fitted with auxiliary heating, the content of the windscreen wiper reservoir is 4,5 litres.
- The wiper blades should be cleaned on a regular basis with a windscreen cleaner to avoid any smears. The wiper blades should be cleaned with a sponge or cloth if they are heavily soiled by insect residues, for example.

Activating the windscreen wipers and washers

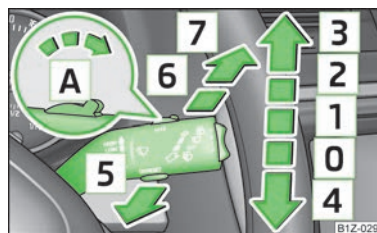

Fig. 35
Windscreen wiper lever



First read and observe the introductory information and safety warnings **i** on page 48.

Flick wipe

- › If you only wish to wipe the windscreen **briefly**, push the lever into the spring-tensioned position [4] » Fig. 35. If the lever is held in the lower position for more than 1 second, the wiper wipes faster.

Periodic wiping

- › Position the lever upwards into position [1] » Fig. 35.
- › Set the desired break between the individual wiper strokes with the switch [A].

Slow wipe

- › Position the lever upwards into position [2] » Fig. 35.

Fast wipe

- › Position the lever upwards into position [3] » Fig. 35.

Automatic wipe/wash for windscreen

- › Pull the lever towards the steering wheel into the spring-tensioned position [5] » Fig. 35, the washer system is activated immediately, while the windscreen wipers start wiping a little later. The wash system and the windscreen wiper operate simultaneously at a speed of more than 120 km/h.
- › Release the lever. The windscreen wash system stops and the wiper continues for another 3 - 4 wiper strokes (depending on the period of spraying of the windscreen). At a speed of more than 2 km/h, the wiper wipes once again 5 seconds after the last wiper stroke in order to wipe the last drops from the windscreen. This feature can be activated/deactivated by a ŠKODA specialist garage.

Rain sensor

- › Place the lever in position [1] » Fig. 35.

- The sensitivity of the sensor can be set individually with the switch **A**.

Wiping the rear window pane

- Push the lever away from the steering wheel into position **6** » Fig. 35 and the windscreen wiper will operate every 6 seconds.

Automatic wipe/wash for the rear window

- Press the lever completely away from the steering wheel into the spring-tensioned position **7** » Fig. 35, the washer system is activated immediately, while the windscreen wiper starts wiping a little later. The wiper and washer system will operate as long as the lever is held in this position.
- Release the lever. The washer system stops and the wiper continues for another 2 to 3 wiper strokes (depending on the duration of the spraying process). The lever will stay in position after releasing it **6**.

Switching windscreen wipers off

- Move the lever back into the home position **0** » Fig. 35.

Winter position

If the windscreen wipers are in rest position, they cannot be folded out from the windscreen. For this reason we recommend adjusting the windscreen wipers in winter so that they can be folded out from the windscreen easily.

This rest position is set as follows:

- Switch on the windscreen wipers.
- Switch off the ignition. The windscreen wipers remain in the position in which they were when switching off the ignition.

The service position can also be used as a winter position » page 51.

Automatic rear window wiper (Combi)



First read and observe the introductory information and safety warnings **!** on page 48.

If the windscreen wiper is in position **2** » Fig. 35 on page 49 or **3** the rear window is wiped every 30 or 10 seconds if the vehicle's speed exceeds 5 km/h.

When the rain sensor is active (the lever is in the position **1**) the function is only active if the windscreen wipers operate in continuous mode (no break between each wiping process).

Activation/deactivation

The function of the automatic rear window wiper is activated/deactivated in the information display in the menu:

- **Settings**
 - **Lights & Vision**
 - **Rear wiper**

Headlight cleaning system



First read and observe the introductory information and safety warnings **!** on page 48.

The headlights are being cleaned after the windscreen has been sprayed for the first time and fifth time, the low beam or main beam are switched on and the windscreen wiper lever was held in the position **5** » Fig. 35 on page 49 for about 1 second.

The headlight washer nozzles are moved forward out of the bumper by the water pressure for cleaning the headlights.

You should remove stubborn dirt (such as insect residues) from the headlight lenses at regular intervals, for example when refuelling. The following guidelines must be observed » page 151, *Headlight lenses*.

To ensure the proper operation of the cleaning system during the winter, any snow should be removed from the washer nozzle fixtures and ice should be cleared with a de-icing spray.



CAUTION

Never remove the nozzles from the headlight cleaning system by hand - risk of damage!

Replacing the windscreen wiper blades

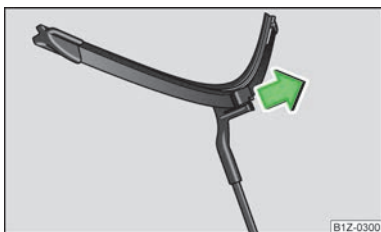

Fig. 36
Windscreen wiper blade



First read and observe the introductory information and safety warnings **!** on page 48.

When in the rest position, the wiper arms cannot be fold down from the windscreen. Before replacing, the wiper arms must be placed in the service position.

Service position for changing wiper blades

- › Closing the bonnet.
- › Switch the ignition off and on again.
- › Then press the windscreen wiper lever into position **4** » Fig. 35 on page 49 within 20 seconds – the wiper arms move into the service position.

Removing the wiper blade

- › Fold the windscreen wiper arm away from the windscreen and position the wiper blade at a right angle to the wiper arm.
- › Remove the wiper blade in the direction of the arrow » Fig. 36.

Attaching the wiper blade

- › Slide the wiper blade over the wiper arm and turn the wiper blade into the vertical position.
- › Check that the wiper blade is correctly attached.
- › Fold the wiper arms back to the windscreen and turn on the ignition. By pressing the window wiper lever into the sprung position **4** » Fig. 36 or when driving at a speed greater than 4 km/h, the windscreen wiper arms move back into the rest position.

Windshield wiper blades in proper condition are essential to obtain good visibility. Wiper blades should not be allowed to become dirtied by dust, insect remains and preserving wax.

Juddering or smearing of the wiper blades could then be due to wax residues left on the windshield by vehicle washing in automatic vehicle wash systems. It is therefore important to **degrease** the lips of the windshield wiper blades after every pass through an **automatic vehicle wash system**.

Replacing the rear window wiper blade

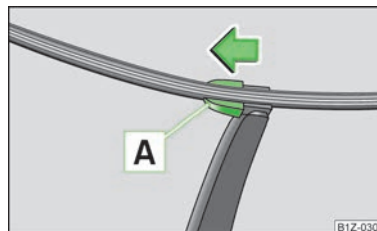

Fig. 37
Rear window wiper blade



First read and observe the introductory information and safety warnings **!** on page 48.

Removing the wiper blade

- › Fold the windscreen wiper arm away from the windscreen and position the wiper blade at a right angle to the wiper arm » Fig. 37.
- › Hold the windscreen wiper arm at the top end with one hand.
- › With the other hand unlock the locking button **A** in the direction of arrow and remove the wiper blade.

Attaching the wiper blade

- › Position the wiper blade onto the wiper arm and lock the locking button **A** » Fig. 37.
- › Check that the wiper blade is correctly attached.
- › Fold the wiper arm back to the windscreen.

Rear window

Manual dimming interior mirror

Basic setting

- › Pull the lever on the bottom edge of the mirror forward. ▶

Dimming mirror

➤ Push the lever on the bottom edge of the mirror backwards.

Automatic dimming interior mirror

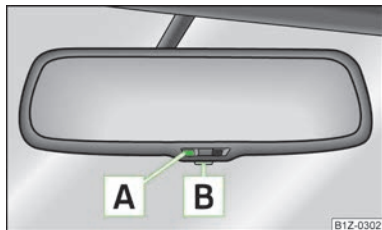

Fig. 38
Automatic dimming interior mirror

Switching on automatic dimming

➤ Press the button **B** » Fig. 38, the warning light **A** lights up.

Switching off automatic dimming

➤ Press the button **B** » Fig. 38 again, the warning light **A** goes out.

If the automatic dimming is switched on, the mirror dims **automatically** depending on the light striking the mirror from the rear. The mirror has no lever on the bottom edge of the mirror. After the reverse gear is engaged, the mirror always moves back into the normal position.

! WARNING

The display lighting on the external navigation device may cause the automatic dimming interior mirror to malfunction - risk of accident. For this reason, do not fix any external navigation systems in the proximity of the automatic dimming interior mirror.

i Note

- Automatic mirror dimming operates only properly if the sun screen for the rear window is not in use or the light striking the rear of the interior rear-view mirror is not affected by other objects.
- Do not affix any stickers in front of the light sensor, so that they do not impair the automatic dimming function or put it out of operation.
- If the automatic interior mirror dimming is switched off, the exterior mirror dimming is also switched off.

Exterior mirror

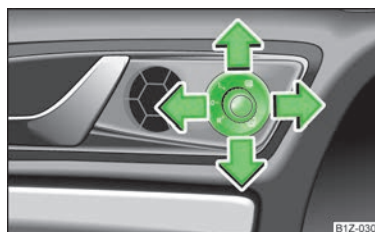

Fig. 39
Inner part of door: Rotary knob

Adjust the rear mirror before commencing to drive so that there is a clear view to the rear.

Heating of the external mirror

➤ Place the rotary knob into the position **☼** » Fig. 39.

The exterior mirror heater only operates when the engine is running and up to an outside temperature of +20 °C.

Adjusting left and right exterior mirrors simultaneously

➤ Place the rotary knob into the position **L**. The movement of the mirror surface is identical to the movement of the rotary knob.

The adjustment of both mirrors simultaneously or each individual mirror is possible in the Information display » page 16 in the menu point **Mirror adjust**.

Adjusting the right-hand exterior mirror

➤ Place the rotary knob into the position **R**. The movement of the mirror surface is identical to the movement of the rotary knob.

Switching off operating control

➤ Place the rotary knob into the position 0.

Folding-in both of the exterior mirrors with the rotary knob

➤ Place the rotary knob into the position ➤.

The mirrors are folded back into the driving position after the rotary knob is turned from the position ➤ to a different one.

It is only possible to fold in both exterior mirrors when the ignition is switched on and at a speed of up to 15 km/h.

Folding-in both of the exterior mirrors using the remote control key

➤ If all of the windows are closed, press and hold the lock button  » Fig. 13 on page 30 on the radio remote control for approx. 2 seconds.

The exterior mirrors are folded back into the driving position after opening the door or switching on the ignition.

Tilting surface of front passenger exterior mirror

On vehicles fitted with the memory function for the driver seat, the surface of the mirror tilts down slightly when the reverse gear is engaged and the rotary knob is in the position  » Fig. 39. This provides an aid in seeing the kerb of the pavement when parking the car.

The mirror returns into its initial position, after the rotary knob is moved out of the position  and put into another position or if the speed is more than 15 km/h.

Memory function for exterior mirrors

On vehicles fitted with a memory function for the driver seat, the relevant setting for the exterior mirrors is also stored automatically when the seat position is stored » page 55.

WARNING

- Convex (curved outward) exterior mirrors increase the field of vision. They do, however, make objects appear smaller in the mirror. These mirrors are therefore only of limited use for estimating distances to the following vehicles.
- Whenever possible use the interior mirror for estimating the distances to the following vehicles.

CAUTION

Never mechanically fold in or fold back the exterior mirrors with the fold-in function ➤ by hand as this will damage the electric drive.

Note

- If the exterior mirrors were folded in using the rotary knob, they can only be folded back into the driving position using the rotary knob.
- If the exterior mirrors were folded in using the remote control key and if the rotary knob was in the fold-in position before the ignition was switched on, the mirrors will remain in the fold-in position the next time the ignition is switched on. The mirrors are folded back into the driving position after the rotary knob is turned from the position ➤ to a different one.
- Do not touch the surface of the exterior mirrors if the exterior mirror heater is switched on.
- If the power setting function fails at any time, the exterior mirrors can be set by hand by pressing on the edge of the mirror surface.
- Contact your ŠKODA specialist garage if there is a fault with the power setting of the exterior mirrors.

Automatic dimming exterior mirror on the driver's side

The exterior mirror on the driver's side is dimmed together with the interior mirror. If the automatic dimming is switched on, the mirror dims **automatically** depending on the light striking the mirror from the rear.

After the reverse gear is engaged, the mirror always moves back into the normal (not dimmed) position.

Note

- Automatic mirror dimming operates only properly if the sun screen for the rear window is not in use or the light striking the rear of the interior rear-view mirror is not affected by other objects.
- Do not affix any stickers in front of the light sensor, so that they do not impair the automatic dimming function or put it out of operation.
- If the automatic interior mirror dimming is switched off, the exterior mirror dimming is also switched off.

Seats and Stowage

Front seats

Introduction

This chapter contains information on the following subjects:

Manually adjusting the front seats _____	55
Adjusting front seats electrically _____	55
Storing setting _____	56
Assigning the remote control key to the memory button _____	56
Retrieving the seat and exterior mirror settings _____	56

The driver's seat should be adjusted in such a way that the pedals can be fully pressed to the floor with slightly bent legs.

The seat backrest on the driver's seat should be adjusted in such a way that the upper point of the steering wheel can be easily reached with slightly bent arms.

Correct adjustment of the seats is particularly important for:

- safely and quickly reaching the controls;
- a relaxed, fatigue-free body position;
- **achieving the maximum protection offered by the seat belts and the airbag system.**

WARNING

- Only adjust the driver's seat when the vehicle is stationary - risk of accident!
- Caution when adjusting the seat! You may suffer injuries or bruises as a result of adjusting the seat without paying proper attention.
- As the electric front seats can also be adjusted when the ignition is switched off (even when the ignition key is withdrawn), never leave children unattended in the car.
- The seat backrests must not be angled too far back when driving otherwise this will affect proper operation of the seat belts and of the airbag system - risk of injury!
- Never carry more people than the number of seats in the vehicle.

WARNING (Continued)

- Each occupant must correctly fasten the seat belt belonging to the seat. Children must be fastened » [page 135](#), *Transporting children safely with a suitable restraint system.*
- The front seats and the head restraints must always be adjusted to match the body size of the seat occupant as well as the seat belts must always be correctly fastened in order to provide an optimal protection for you and your occupants.
- Always keep your feet in the footwell when the car is being driven - never place your feet on the instrument panel, out of the window or on the surfaces of the seats. This is particularly important for the front seat passenger. You will be exposed to increased risk of injury if it becomes necessary to apply the brake or in the event of an accident. If an airbag is deployed, you may suffer fatal injuries when adopting an incorrect seated position!
- It is important for the driver and front passenger to maintain a distance of at least 25 cm from the steering wheel or dash panel. Not maintaining this minimum distance will mean that the airbag system will not be able to properly protect you - hazard!
- Ensure that there are no objects in the footwell as they may get caught behind the pedals when driving or applying the braking. You would then no longer be able to operate the clutch, brake or accelerate.
- Do not transport any objects on the front passenger seat except objects (e.g. child safety seat) provided for this purpose - risk of accident!

Note

After a certain time, play can develop within the adjustment mechanism of the backrest angle.

Manually adjusting the front seats

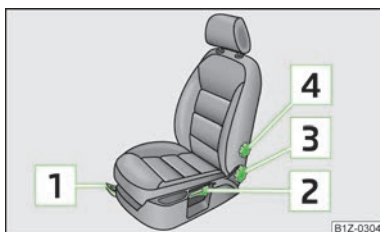







Fig. 40
Controls for manual seat adjustment

 First read and observe the introductory information and safety warnings  on page 54.

Adjusting a seat in a forward/back direction

- > Pull the lever  » Fig. 40 up and push the seat into the desired position.
- > Release the lever  and push the seat until the lock clicks into place.

Adjusting height of seat

- > To lift the seat, pull or pump the lever  » Fig. 40 upwards.
- > To lower the seat, push or pump the lever  downwards.

Adjusting the angle of the seat backrest

- > To adjust the angle of the backrest, relieve any pressure from the seat backrest (do not lean on it) and turn the handwheel  » Fig. 40.

Adjusting lumbar support

- > Turn the hand wheel  » Fig. 40 until the most comfortable curvature of the lumbar support is achieved.

Adjusting front seats electrically

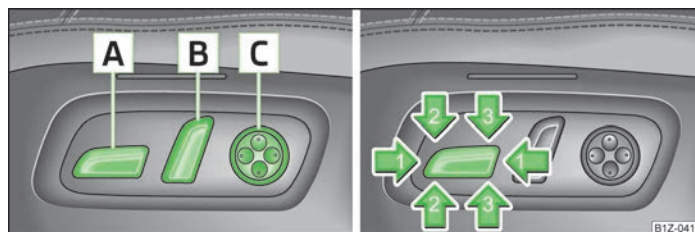



Fig. 41 Controls for the electric seat adjustment

 First read and observe the introductory information and safety warnings  on page 54.

Adopt the correct seated position before setting » page 54, *Front seats*.

Adjusting a seat in a forward/back direction

- > Press the switch  » Fig. 41 forwards or backwards in the direction of arrow 1.

Set the height of the seat cushion

- > Press the switch  » Fig. 41 upwards or downwards.

Adjust the angle of the seat cushion

- > Press the switch  » Fig. 41 in the direction of the arrow 2 or 3.

Adjusting the angle of the seat backrest

- > Press the switch  » Fig. 41 in the direction of the desired setting.

Reducing or increasing the curvature of the lumbar support

- > Press the switch  forwards or backwards.

Raising or lowering the curvature of the lumbar support

- > Press the switch  upwards or downwards.

Note

If the movement of the seat is inadvertently interrupted during an adjustment, once again press the switch in the appropriate direction and complete the adjustment of the seat.

Storing setting

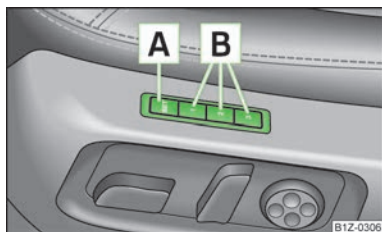







Fig. 42
Memory buttons and SET button



 First read and observe the introductory information and safety warnings  on page 54.

The memory function for the driver's seat provides the option to store the individual positions of the driver's seat and the external mirrors. A setting position can be allocated to each of the three memory buttons  » Fig. 42, i.e. three in total.

Storing seat and exterior mirror settings for driving forward

- Switch on the ignition.
- Adjust the seat » page 55, *Adjusting front seats electrically*.
- Adjust both of the exterior mirrors » page 52.
- Press the button   » Fig. 42.
- Press one of the memory buttons  within 10 seconds after pressing the button  - an acknowledgement signal confirms that the seat setting is stored.

Storing exterior mirror setting for reversing

- Switch on the ignition.
- Press the required memory button  » Fig. 42.
- Move the rotary knob for the exterior mirror control into position  » page 52.
- Engage reverse gear.
- Move the right exterior mirror into the desired position » page 52.
- Take the vehicle out of gear. The set position of the exterior mirror is stored.

Emergency Off

The setting process can be interrupted if necessary, by pressing any button on the driver's seat.

Note

- Each new setting stored with the same button erases the previous setting.
- Each time new seat and exterior mirror settings for forward travel are saved, the individual setting for the right exterior mirror for reverse travel must also be saved again.

Assigning the remote control key to the memory button

 First read and observe the introductory information and safety warnings  on page 54.

The remote control key must be assigned to the memory button to be able to retrieve the settings that are stored in the memory function via the remote control key.

Once the settings for the seat and exterior mirrors are saved » page 56, *Storing setting*, you have 10 seconds to assign the radio remote control to the appropriate memory button.

- Withdraw the ignition key.
- Press the button  on the remote control key. After the successful assignment, the turn signal lights flash and an audible signal will sound as a confirmation. The setting is stored with the memory button which you have selected.



Note

If the remote control key is assigned to a memory button, which has already been assigned to a radio remote control, the old assignment is replaced by the new assignment.

Retrieving the seat and exterior mirror settings

 First read and observe the introductory information and safety warnings  on page 54.

Retrieving settings via the memory button

- **One-touch automatic memory:** briefly press the desired memory button  » Fig. 42 on page 56. The seat and exterior mirror are moved automatically into the stored positions (this applies only if the ignition is switched on and the speed is less than 5 km/h).
- **Memory buttons:** Press and hold the desired memory button  until the seat and the exterior mirrors are moved into the stored positions.

Retrieving settings via the remote control key

➤ If the driver's door is closed and the ignition is switched off, briefly press the button  on the remote control key and open the driver's door.

The seat and exterior mirrors now move automatically into the stored positions.

Retrieving setting of exterior mirror for reversing

➤ Turn the rotary knob for the exterior mirror setting into the position  » page 52 before engaging the reverse gear.

➤ Engage reverse gear.

The mirror returns into its initial position, after the rotary knob is moved out of the position  and put into another position or if the speed is more than 15 km/h.

Emergency Off

The setting process for the seats and exterior mirrors can be interrupted if necessary, by pressing any button on the driver's seat.

With repeated pressing of the switch, the intensity of the heating is down-regulated up to the switch-off. The intensity of the heating is indicated by the number of illuminated warning lights in the switch.

WARNING

If, as an occupant, you have a subdued pain and/or temperature sensitivity, e.g. through medication, paralysis or because of chronic illness (e.g. diabetes), we recommend not to use the seat heating. This can lead to burns on the back, the posterior and the legs which are difficult to heal. If the seat heating is used, we recommend to make regular breaks in your journey when driving long distances, so that the body can recuperate from the stress of the journey. Please consult your doctor, who can evaluate your specific condition.

CAUTION

- Do not kneel on the seats or otherwise apply pressure at specific points to avoid damaging the heating elements for the seat heaters.
- Do not use the seat heaters if the seats are not occupied by persons or if objects, such as a child seat, bag, etc., are fastened or stored on them. A fault of the heating elements in the seat heating can occur.
- Do not clean the seats using moisture » page 153, *Fabric covers on electrically heated seats.*

Note

- The seat heating should only be switched on when the engine is running. This has a significant effect of saving on the battery capacity.
- If the on-board voltage drops, the seat heating is switched off automatically, in order to provide sufficient electrical energy for the engine control » page 169, *Automatic load deactivation.*
- If the heaters for the rear seats are set to the highest intensity - level 3, they are automatically switched over to level 2 after 10 minutes (two warning lights are illuminated on the switch).

Seat heaters

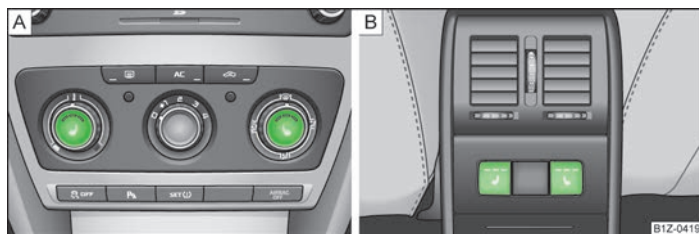







Fig. 43 Regulator for heating the front seats/rear seats

The seat backrests and surfaces of the front seats and the two outer rear seats can be heated electrically.

➤ The seat heaters on the driver's and front passenger's seat can be switched on and regulated by pressing the button in the area of the symbol  or  » Fig. 43 - .

➤ The heaters on the left or right rear seats can be switched on and regulated by pressing the regulator  or  » Fig. 43 - .

By pressing the button once, the heating is switched to the highest intensity - level 3, which is indicated by all three of the warning lights in the switch lighting up.

Head restraints

Introduction

This chapter contains information on the following subjects:

Adjusting, removing and installing a head restraint	58
Middle rear head restraint	58

Best protection is achieved if the top edge of the head restraint is at the same level as the upper part of your head.

The position of the front and rear outer head restraints is adjustable in height. The middle rear head restraint is adjustable in two positions.

The head restraints must be adjusted to match the size of the seat occupant. Correctly adjusted head restraints together with the seat belts offer effective protection for the occupants » [page 122, Correct seated position.](#)

! WARNING

- The head restraints must be correctly adjusted in order to offer effective protection for the occupants in the event of an accident.
- Never drive with the head restraints removed - risk of injury.
- If the rear seats are occupied, the rear head restraint must not be in the lower position.

Adjusting, removing and installing a head restraint

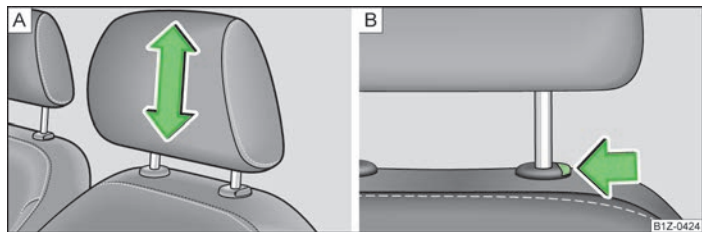

Fig. 44 Head restraint: adjusting/removing



First read and observe the introductory information and safety warnings **!** on page 58.

Adjusting the height of a head restraint

- Grasp the side of the head restraint with both hands and push it upwards as required » [Fig. 44 - A](#).
- To move the head restraint downwards, press and hold the safety button » [Fig. 44 - B](#) with one hand and press the head restraint downwards with the other hand.

Removing and installing a head restraint

- Pull the head restraint up out of the seat backrest as far as the stop (for the rear head restraints fold the seat backrest forward).
- Press the locking button in direction of the arrow » [Fig. 44 - B](#) and pull the head restraint out.
- To re-insert the head restraint, push it far enough down into the seat backrest until the locking button clicks into place.

Middle rear head restraint

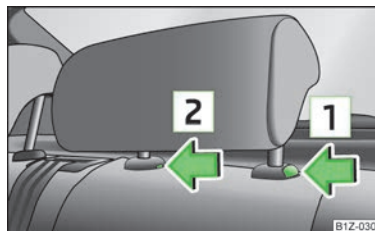

Fig. 45
Rear seats: middle head restraint



First read and observe the introductory information and safety warnings **!** on page 58.

Applies to vehicles using the TOP TETHER system.

Removing and installing

- Pull the head restraint out of the seat backrest as far as the stop.
- Press the locking button in the direction of arrow **1** » [Fig. 45](#), simultaneously press the locking button into the opening **2** using a flat screwdriver with a width of maximum 5 mm and pull out the head restraint.
- To re-insert the head restraint, push it far enough down into the seat backrest until the locking button clicks into place.

Rear seats

Folding the seat backrest forwards

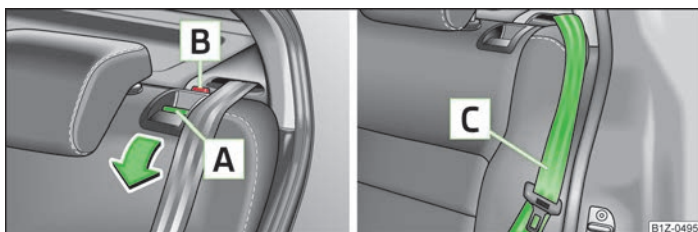

Fig. 46 Unlock the seat backrest/lock the seat backrest

The luggage compartment can be increased in size by folding the seat backrests forward. The seat backrests can be folded forward individually on vehicles with divided rear seats.

Folding the seat backrest forwards

- Before folding the seat backrests forwards, adapt the position of the front seats in such a way that they are not damaged by the folded seat backrests ¹⁾.
- Unlock the seat backrest by pressing the securing knob **A** » Fig. 46 and fold it completely forwards.

Folding the seat backrest back into position

- Place the rear outer seat belt **C** » Fig. 46 behind the edge of the side trim panel.
- Then push the seat backrest back into the upright position until the securing knob clicks into place - check by pulling on the seat backrest » **!**.
- Make sure that the red pin **B** is hidden.

¹⁾ If the front seats are too far back, we recommend that you have the rear head restraints removed before the seat backrests are folded forward. Store the removed head restraints in such a way that they are not be damaged or soiled.

! WARNING

- The belts and the belt locks must be in their original position after folding back the seat backrests - they must be ready to use.
- The seat backrests must be securely interlocked in position so that no objects in the luggage compartment can slide into the passenger compartment if there is sudden braking - risk of injury!
- Ensure that the rear seat backrests are properly engaged. It is only then that the three-point seat belt for the middle seat can reliably fulfil its function.

! CAUTION

Ensure that the seat belts are not damaged when operating the seat backrests. Under no circumstances must the rear seat belts be jammed by the folded back seat backrests.

Folding the seat cushions forwards, removing

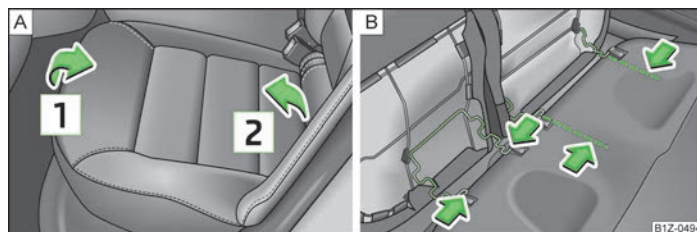

Fig. 47 Removing the seats

On vehicles with divided rear seats, the luggage compartment can be enlarged even more by folding the rear seats and removing them.

Folding forward

- Pull up the seat cushion in the direction of the arrow **1** » Fig. 47 and fold forwards in the direction of the arrow **2**.

Removing

- Fold the seat cushion forward.
- Press the wire clamps in the direction of the arrow » Fig. 47 - B and remove the seat cushion from its holder.

Install

- Press the wire clamp in the direction of the arrow » Fig. 47 - B and put it into the holder.
- Fold the seat cushion back into its original position.

! CAUTION

For vehicles with heated rear seats it is necessary to disconnect the plug connection for the power supply before removing the seat cushion. For reinstalling the seat cushion it is necessary to re-connect the plug connection.

Rear armrest

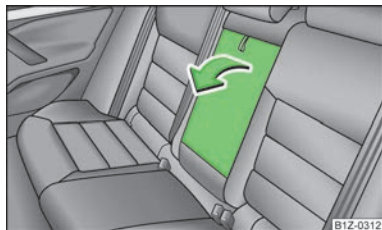

Fig. 48
Rear seats: Armrest

- The armrest can be folded down to increase comfort using the loop » Fig. 48.

Boot

Introduction

This chapter contains information on the following subjects:

Class N1 vehicles	61
Fastening elements	61
Folding double hooks	62
Folding hooks (Estate car)	62

Fixing nets	62
Fixing floor covering of the boot	63
Luggage net	63
Boot cover	63
Foldable boot cover (Combi)	64

Please observe the following for the purpose of maintaining good handling characteristics of your vehicle:

- Distribute loads as evenly as possible.
- Place heavy objects as far forward as possible.
- Attach the items of luggage to the lashing eyes or using the fixing net » page 61.

In the event of an accident, there is such a high kinetic energy which is produced by small and light objects that they can cause severe injuries. The magnitude of the kinetic energy is dependent on the speed at which the vehicle is travelling and the weight of the object. The speed at which the vehicle is travelling is in this case the more significant factor.

Example: In the event of a frontal collision at a speed of 50 km/h, an unsecured object with a weight of 4.5 kg produces an energy, which corresponds to 20 times its own weight. This means that it results in a weight of approx. 90 kg ". You can imagine the injuries that can occur, if this "object" flies through the interior compartment and hits an occupant.

! WARNING

- Store the objects in the boot and attach them to the lashing eyes.
- Loose objects in the passenger compartment can be thrown forward during a sudden manoeuvre or in case of an accident and can injure the occupants or other oncoming traffic. This risk is still increased, if the objects which are flying around are hit by a deployed airbag. In this case, the objects which are thrown back can injure the occupants - hazard.
- Please note that the handling properties of the vehicle may be affected when transporting heavy objects as the centre of gravity can be displaced - risk of accident! The speed and style of driving must be adjusted accordingly.
- If the items of luggage or objects are attached to the lashing eyes with unsuitable or damaged lashing straps, injuries can occur in the event of braking manoeuvres or accidents. To prevent items of luggage from being thrown forward, always use suitable lashing straps which must be firmly attached to the lashing eyes.

! WARNING (Continued)

- The items carried in the boot must be stored in such a way that no objects are able to slip forward if any sudden driving or braking manoeuvres are undertaken - risk of injury!
- When transporting fastened objects which are sharp and dangerous in the boot that has been enlarged by folding the rear seats forward, ensure the safety of the passengers transported on the other rear seats » [page 123](#), *Correct seated position for the occupants on the rear seats*.
- If the rear seat next to the folded forward seat is occupied, ensure maximum safety, e.g. by placing the goods to be transported in such a way that the seat is prevented from folding back in case of a rear collision.
- Never drive with the boot lid fully opened or slightly ajar otherwise exhaust gases may get into the interior of the vehicle - risk of poisoning!
- Under no circumstances, should the permissible axle loads and permissible gross weight of the vehicle be exceeded - risk of accident!
- Never transport people in the boot!

! CAUTION

Make sure that transported objects with sharp edges do not damage the following:

- heating elements in the rear window;
- elements of the aerial integrated in the rear window;
- elements of the aerial integrated in the rear side windows (Estate car).

i Note

Tyre pressure must be adjusted to the load » [page 171](#), *Service life of tyres*.

Class N1 vehicles



First read and observe the introductory information and safety warnings ! on page 60.

On class N1 vehicles, which are not fitted with a protective grille, a lashing set which complies with the standard EN 12195 (1 - 4) must be used for fastening the load.

Fastening elements

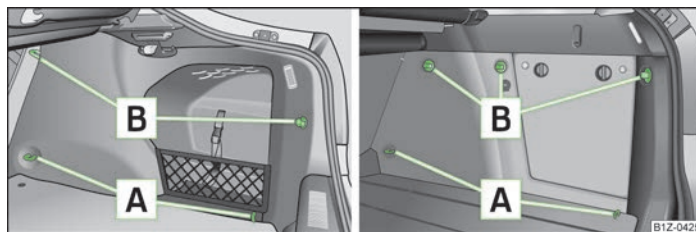

Fig. 49 Boot: Lashing eyes and fastening elements/Combi lashing eyes and fastening elements



First read and observe the introductory information and safety warnings ! on page 60.

The boot provides the following fastening elements » [Fig. 49](#).



Lashing eyes for fastening items of luggage and fixing nets.



Fastening elements for fastening fixing nets.



CAUTION

The maximum permissible load of the lashing eyes is 3.5 kN (350 kg).



Note

The upper front lashing eyes are located underneath the folding rear seat backrest » [Fig. 49](#).

Folding double hooks

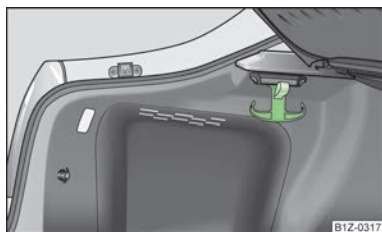



Fig. 50
Boot: Folding double hooks

 First read and observe the introductory information and safety warnings  on page 60.

Folding double hooks for attaching small items of luggage, such as bags etc. are provided on one or both sides of the luggage compartment depending on the equipment installed in the vehicle » Fig. 50.

CAUTION

An item of luggage weighing up to 5 kg can be attached to each side of the double hook.

Folding hooks (Estate car)

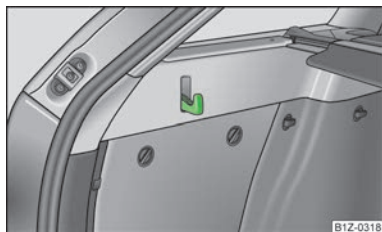



Fig. 51
Boot: folding hooks

 First read and observe the introductory information and safety warnings  on page 60.

Folding hooks for attaching small items of luggage, such as bags etc., are provided on both sides of the boot » Fig. 51.

CAUTION

The maximum permissible load of the hook is 7.5 kg.

Fixing nets

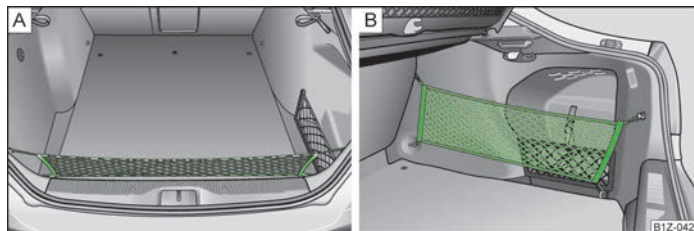

Fig. 52 Fixing net: Horizontal pocket/vertical pocket

 First read and observe the introductory information and safety warnings  on page 60.

Fixing examples for a fixing net as a horizontal pocket » Fig. 52 - A and vertical pocket » Fig. 52 - B.

WARNING

Do not exceed the maximum permissible load of the fixing nets. Heavy objects are not secured sufficiently - risk of injury!

CAUTION

- The maximum permissible load of the fixing nets is 1.5 kg.
- Do not place any sharp objects in the nets - risk of damaging the net.

Fixing floor covering of the boot

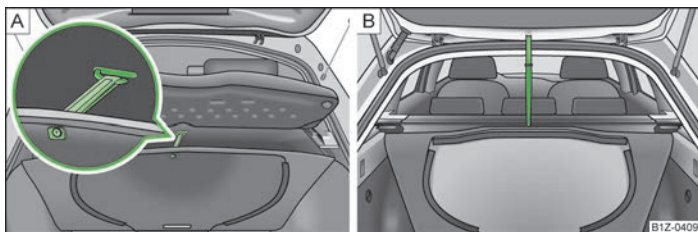



Fig. 53 Boot: Securing the floor covering

 First read and observe the introductory information and safety warnings  on page 60.

There is a loop or hook (Combi) located on the floor covering of the boot. If you need to access the spare wheel, for example, the raised floor cover can be attached to a hook on the boot cover  [Fig. 53 - A](#)) or to the frame of the boot lid (Combi)  [Fig. 53 - B](#).

Luggage net

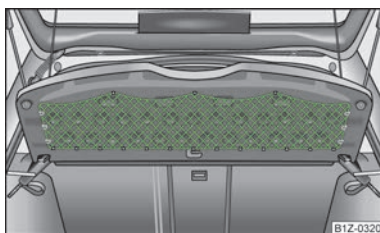



Fig. 54
Boot: Luggage net

 First read and observe the introductory information and safety warnings  on page 60.

The luggage net is designed for the transportation of lighter objects.

WARNING

Only store soft objects in the luggage net (up to a total weight of 1.5 kg). Heavy objects are not secured sufficiently - risk of injury!

CAUTION

No objects with sharp edges should be stored in the luggage net, as they can damage the luggage net.

Boot cover

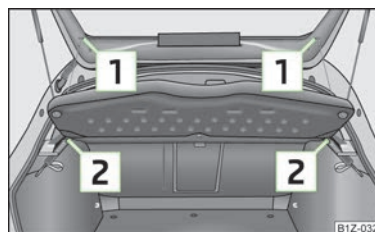











Fig. 55
Removing the boot cover

 First read and observe the introductory information and safety warnings  on page 60.

The boot cover can be removed if you wish to transport bulky goods.

-  Unhook the support straps   [Fig. 55](#).
-  Place the cover in the horizontal position.
-  Pull the cover out of the holders  horizontally towards the rear.
-  To reinstall, first of all push the boot cover into the holders  and then hook the support straps  on the boot lid.

The removed boot cover can be stowed behind the seat backrest.

WARNING

No objects should be placed on the boot cover, the vehicle occupants could be endangered if there is sudden braking or the vehicle collides with something. 

! CAUTION

Please ensure that the heating elements for the rear window heater are not damaged as a result of objects placed in this area.

i Note

Opening the boot lid also lifts up the boot cover.

Foldable boot cover (Combi)

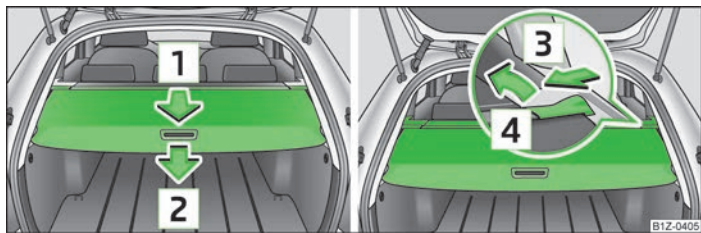





Fig. 56 Boot: foldable boot cover/removing foldable boot cover

 First read and observe the introductory information and safety warnings  on page 60.



Pulling out

➤ Pull the foldable luggage compartment cover in direction of arrow  » Fig. 56 as far as the stop into the secured position.

Folding

➤ Press the cover in the handle area in the direction of the arrow  » Fig. 56, and the cover automatically rolls up into position.

Removing

➤ The fully folded luggage compartment cover can be removed to transport bulky goods by pressing on the side of the cross rod in the direction of the arrow  » Fig. 56 and taking it out by moving it in the direction of the arrow .

! WARNING

No objects should be placed on the foldable boot cover.

Variable loading floor in the boot

Introductory information

The variable loading floor makes handling of bulky items of luggage easier.

! CAUTION

The maximum permissible load of the variable loading floor is 75 kg.

i Note

The room under the variable loading floor can be used to stow objects.

Dividing the boot with variable loading floor

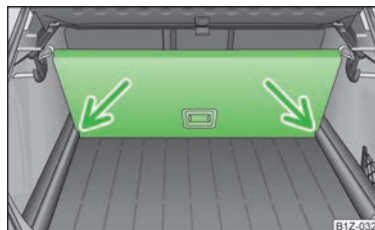

Fig. 57
Boot: Dividing the boot with variable loading floor

➤ Lift up the part with the holder and secure it by sliding it into the grooves marked with the arrows » Fig. 57.

Removing the variable loading floor

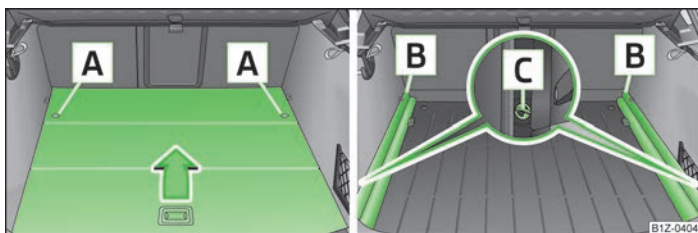

Fig. 58 Boot: Remove variable loading floor/remove carrier rails

- Unlock the variable loading floor by turning the safety eyes **A** » Fig. 58 to the left by around 90°.
- Fold up and remove the loading floor by moving it in the direction of the arrow.
- Unlock the carrier rails **B** by turning the arbour-mounted fixing eyes **C** to the right by approx. 90°.

! WARNING

Ensure that the carrier rails and variable loading floor are correctly fastened when installing the variable loading floor. If this is not the case, there is a risk of injury for the occupants.

Net partition (Combi)

Introduction

This chapter contains information on the following subjects:

Using the net partition behind the rear seats	_____	65
Using the net partition behind the front seats	_____	66
Removing and installing net partition housing	_____	66

! WARNING

- The belt locks and the belts must be in their original position after folding back the seat cushions and backrests - they must be ready to use.
- The seat backrests must be securely interlocked in position so that no objects in the boot can slide forwards if there is sudden braking - risk of injury!
- Ensure that the rear seat backrests are properly engaged. It is only then that the three-point seat belt for the middle seat can reliably fulfil its function.
- Ensure that the cross rod is inserted into the mounts **C** » Fig. 59 on page 65 or » Fig. 60 on page 66 in the front position!

Using the net partition behind the rear seats

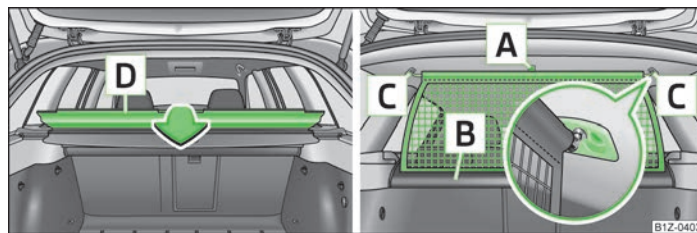

Fig. 59 Folding down the storage compartment cover/pulling out the net partition

First read and observe the introductory information and safety warnings **!** on page 65.

Pulling out

- Fold down the storage compartment cover **D** » Fig. 59 behind the rear seats.
- Pull the net partition by the bracket **A** out of the housing **B** in direction of the mounts **C**.
- Insert the cross rod into one of the mounts **C** and push forwards.
- In the same way, insert the cross rod into the mount **C** on the other side of the vehicle.
- Fold the storage compartment cover **D** downwards.

Folding

- Fold down the storage compartment cover **D** » Fig. 59 behind the rear seats. ▶

- First pull the cross rod back slightly on the one side and then on the other side and remove it from the mounts **[C]**.
- Hold the cross rod in such a way that the net partition can slowly roll up into the housing **[B]** without being damaged.
- Fold the storage compartment cover **[D]** downwards.

If you wish to use the entire boot, the foldable boot cover can be removed » Fig. 56 on page 64.

Using the net partition behind the front seats

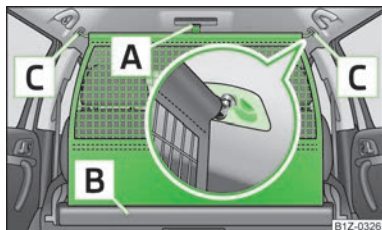

Fig. 60
Pull out the net partition

First read and observe the introductory information and safety warnings **[!]** on page 65.

Pulling out

- Fold the rear seats forward » page 59.
- Pull the net partition by the bracket **[A]** » Fig. 60 out of the housing **[B]**.
- First of all insert the cross rod into the mount **[C]** on one side and push it forward.
- In the same way, insert the cross rod into the mount **[C]** on the other side of the vehicle.

Folding

- First pull the cross rod back slightly on the one side and then on the other side and remove it from the mounts **[C]** » Fig. 60.
- Hold the cross rod in such a way that the net partition can slowly roll up into the housing **[B]** without being damaged.
- Fold the rear seats back into their original position.

Removing and installing net partition housing

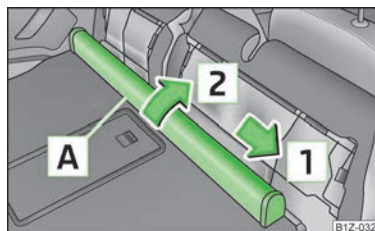

Fig. 61
Rear seats: Net partition housing

First read and observe the introductory information and safety warnings **[!]** on page 65.

Removing

- Fold the rear seats forward » page 59.
- Open the rear right door.
- Push the net partition housing **[A]** » Fig. 61 in the direction of the arrow **[1]** and remove it from the mounts on the rear seats in the direction of the arrow **[2]**.

Install

- Insert the recesses on the net partition housing into the mounts on the rear seat backrests.
- Push the net partition housing in the opposite direction of the arrow **[1]** » Fig. 61 as far as the stop.
- Fold the rear seats back into their original position.

Roof rack system

Introduction

This chapter contains information on the following subjects:

Attachment points	_____	67
Roof load	_____	67▶

! WARNING

- The items which you transport on the roof bar system must be reliably attached - risk of accident!
- Always secure the load with appropriate and undamaged lashing straps or tensioning straps.
- Distribute the load evenly over the roof rack system.
- The handling properties of your vehicle change when you transport heavy or bulky items on the roof bar system as a result of the displacement of the centre of gravity and the increased wind attack area - risk of accident! The style of driving and speed must therefore be adapted to the current circumstances.
- Avoid abrupt and sudden driving/braking manoeuvres.
- Adjust the speed and driving style to the visibility, weather, road and traffic conditions.
- The permissible roof load, permissible axle loads and gross permissible weight of your vehicle must not be exceeded under any circumstances - risk of accident!

! CAUTION

- Only use roof rack systems approved by ŠKODA.
- If other roof rack systems are used or if the roof bars are not fitted correctly, any resulting damage to the vehicle is not covered by the warranty. It is therefore essential that the supplied fitting instructions for the roof rack system are observed.
- On models fitted with a power sliding/tilting roof, ensure that the opened sliding/tilting roof does not strike any items of luggage transported on the roof.
- Ensure that the boot lid does not hit the roof load when opened.
- The height of the vehicle changes after mounting a roof luggage rack system and the load that is secured to it. Compare the vehicle height with available clearances, such as underpasses and garage doors.
- Always remove the roof luggage rack system before entering an automated car wash.
- Ensure the roof aerial is not impaired by the secured load.

For the sake of the environment

The increased aerodynamic drag results in a higher fuel consumption.

i Note

If the vehicle is not factory-equipped with a roof rack, it can be purchased from the ŠKODA Original Accessories.

Attachment points

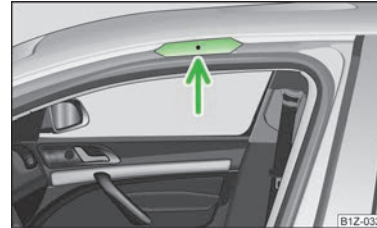

Fig. 62
Attachment points for roof bars



First read and observe the introductory information and safety warnings **!** on page 66.

Perform the assembly and disassembly according to the enclosed instructions.

! CAUTION

Observe the information regarding the assembly and disassembly in the enclosed instructions.

i Note

The figure only applies to Combi vehicles.

Roof load



First read and observe the introductory information and safety warnings **!** on page 66.

The maximum permissible roof load (including roof rack system) of **75 kg** and the maximum permissible total weight of the vehicle should not be exceeded. ▶

The full permissible roof load cannot be used if a roof rack system with a lower load carrying capacity is used. In this case, the roof rack system must only be loaded up to the maximum weight limit specified in the fitting instructions.

Cup holder

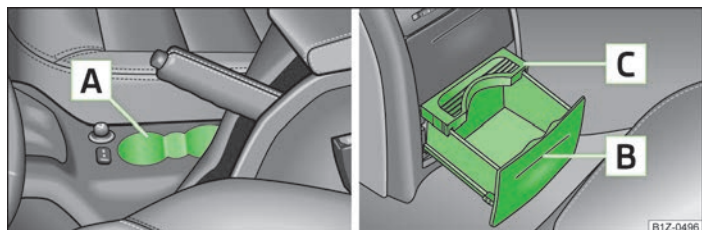

Fig. 63 Cup holder

Cup holder in front centre console

Two beverage containers can be placed into the recesses **A** » Fig. 63.

Cup holder in rear centre console

- » Press on the panel in the area **B** » Fig. 63 - the cup holder comes out.
- » Pull the cup holder out as far as the stop.
- » Adjust the cup holder by moving the locking plate **C**.

! WARNING

- Never put hot beverage containers in the cup holder. If the vehicle moves, they may spill - risk of scalding!
- Do not use any cups or beakers which are made of brittle material (e.g. glass, porcelain). This could lead to injuries in the event of an accident.

! CAUTION

Do not leave open beverage containers in the cup holder during the journey. There is a risk of spilling e.g. when braking which may cause damage to the electrical components or seat upholstery.

Ashtray

Front ashtray

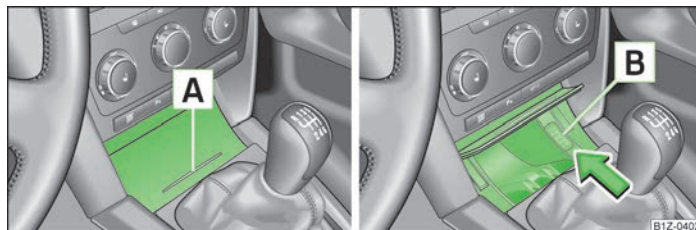

Fig. 64 Centre console: Opening the ashtray/ashtray insert

Opening

- » Press on the bottom part of the cover of the ashtray in area **A** » Fig. 64.

Removing ashtray insert

- » Press on the ashtray insert in the region **B** » Fig. 64 (the insert comes out) and take it out.

Insert ashtray insert

- » Place the ashtray insert in the mount and press it in.

! WARNING

Never place flammable objects in the ashtray - risk of fire!

Rear ashtray

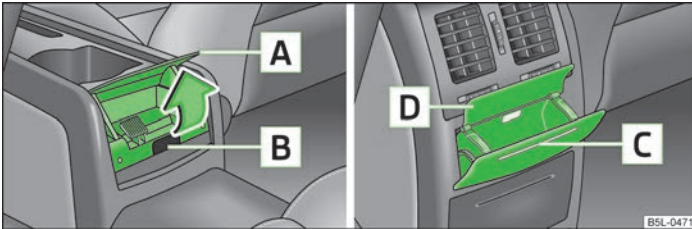

Fig. 65 Rear ashtray - low centre console/high centre console

Opening the ashtray on the low centre console

- Grasp the ashtray cover at the lower edge **A** » Fig. 65 and fold it open in the direction of arrow.

Remove the ashtray from the low centre console

- Grasp the ashtray at the handle **B** » Fig. 65 and remove from above.

Removing the ashtray from the low centre console

- Place the ashtray insert into the console and press it in.

Opening the ashtray on the high centre console

- Press on the top part of the ashtray cover in area **C** » Fig. 65.

Removing the ashtray from the high centre console

- Lightly push the ashtray cover downwards as far as the stop.
- Grasp the ash tray insert at the cover **D** » Fig. 65 and remove.

Inserting the ashtray into the high centre console

- Place the ashtray insert in the mount and press it in.

! WARNING

Never place flammable objects in the ashtray - risk of fire!

Cigarette lighter, 12-volt power socket

Cigarette lighter



Fig. 66
Centre console: Cigarette lighter

Using the system

- Press in the button of the cigarette lighter » Fig. 66.
- Wait until the button pops forward.
- Remove the cigarette lighter immediately and use.
- Place the cigarette lighter back into the socket.

! WARNING

- Take care when using the cigarette lighter! Improper use of the cigarette lighter can cause burns.
- The cigarette lighter also operates when the ignition is switched off or the ignition key withdrawn. Therefore never leave children unattended in the vehicle.

i Note

- The cigarette lighter socket can also be used as a 12Volt socket for electrical appliances » page 70, 12-volt power socket.
- Further information » page 177, Accessories, changes and replacement of parts.

12-volt power socket

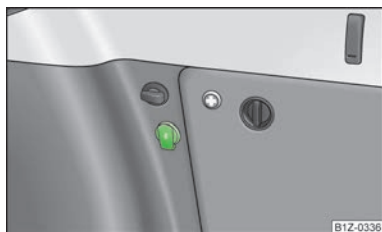

Fig. 67
Boot: Power socket

Overview of the 12-volt power socket

In the front centre console » Fig. 66 on page 69.

In the boot » Fig. 67.

Using the power socket

- Remove the cover from power socket or cigarette lighter, or open the cover for the power socket.
- Connect the plug for the electrical appliance to the socket.

Further information » page 177, *Accessories, changes and replacement of parts.*

! WARNING

- Improper use of the 12-volt power socket and the electrical accessories can cause fires, burns and other serious injuries.
- Never leave children unattended in the vehicle. The 12-volt power socket and any connected appliances can also be operated when the ignition is switched off or the ignition key is withdrawn.
- If the connected electric device becomes too hot, switch it off and disconnect it from the power supply immediately.

! CAUTION

- Never exceed the maximum power consumption, otherwise the vehicle's electrical system can be damaged.
- Connecting electrical components when the engine is not running will drain the battery of the vehicle - risk of battery draining!
- Only use matching plugs to avoid damaging the 12-volt power socket.

- Only use accessories that have been tested for electromagnetic compatibility in accordance with the applicable directives.
- Before turning the ignition on or off, and before starting the car, switch off the device connected to the 12-volt power socket to prevent any damage caused by voltage fluctuations.
- Observe the operating instructions for the connected devices!

i Note

The 12-volt power socket can only be used for connecting approved electrical accessories with a total power uptake of up to 120 watt.

Storage compartments

Overview

The vehicle has the following storage compartments:

Storage compartment on the front passenger side	» page 71
Storage compartment on the driver's side	» page 71
Storage compartment on the dash panel	» page 72
Storage compartment in front centre console	» page 72
Storage net in the front centre console	» page 72
Map pockets in the front seats	» page 73
Glasses storage box	» page 73
Storage compartments in the doors	» page 73
Storage compartment below front passenger seat	» page 74
Front armrest with storage compartment	» page 74
Rear armrest with storage compartment	» page 75
Storage compartment in rear centre console	» page 75
Seat backrest with through-loading channel	» page 75
Removable through-loading bag	» page 76
Side compartment in the luggage compartment	» page 77
Storage compartment behind the rear seats (Estate car)	» page 77

! WARNING

- Do not place anything on the dash panel. These objects might slide or fall down when driving (when accelerating or cornering) and may distract you from concentrating on the traffic - risk of accident!
- When driving, ensure that no objects from the centre console or from other storage compartments can get into the driver's footwell. You would then no longer be able to apply the brakes, operate the clutch or accelerator - risk of accident!

Storage compartment on the front passenger side



Fig. 68
Dash panel: Storage compartment on the front passenger side

Open/close

- Press the handle » Fig. 68 and the lid folds down.
- Lift the lid upwards until it clicks into place.

The inside of the flap contains pen and note book holders.

! WARNING

The storage compartment must always be closed when driving for safety reasons.

Cooling the storage compartment on the front passenger side

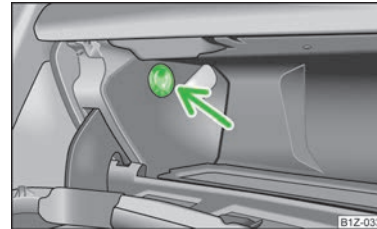

Fig. 69
Storage compartment: Using cooling system

- Use the rotary switch » Fig. 69 to open/close the air supply.

Opening the air supply when the air conditioning system is switched on allows cooled air to flow into the storage compartment.

Opening the air inlet when the air conditioning system is on causes fresh or interior air to flow into the storage compartment.

We recommend closing the air supply if it is operated in heating mode or the cooling system for the storage compartment is not being used.

Storage compartment on the driver's side



Fig. 70
Dash panel: Storage compartment on the driver's side

- The storage compartment is opened by lifting the handle and folding open in the direction of arrow » Fig. 70.

! WARNING

The storage compartment must always be closed when driving for safety reasons.

Storage compartment on the dash panel

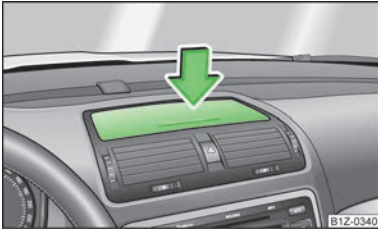

Fig. 71
Dash panel: Storage compartment

► Press in the middle of the storage compartment » Fig. 71 - the lid folds open.

Certain models do not have a storage compartment lid.

! WARNING

- The storage compartment is not a substitute for the ashtray and must also not be used for such purposes - risk of fire!
- The storage compartment must always be closed when driving for safety reasons.
- Do not put any highly inflammable objects or objects which are sensitive to heat (e.g. lighters, sprays, spectacles, carbonated drinks) in the storage compartment.

Storage compartment in front centre console

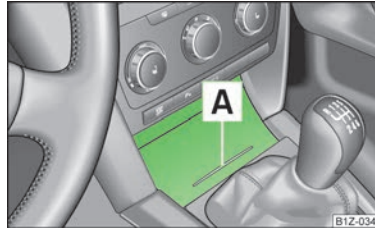

Fig. 72
Front centre console: Storage compartment

► Press on the bottom part of the storage compartment in the area **A** » Fig. 72, and the lid folds open.

! WARNING

The storage compartment is not a substitute for the ashtray and must also not be used for such purposes - risk of fire!

Storage net in the front centre console

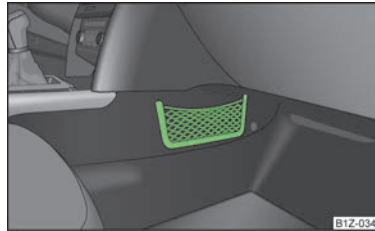

Fig. 73
Front centre console: Storage net

! WARNING

Only store soft objects with a total weight of 0.5 kg in the storage net. Heavy objects are not secured sufficiently - risk of injury!

! CAUTION

No objects with sharp edges should be stored in the storage net, as they can damage the storage net.

Map pockets in the front seats



Fig. 74
Front seat rests: Map pockets

Map pockets are located on the rear of the seat backrests » Fig. 74.

The map pockets are intended for storage of maps, magazines, etc.

! WARNING

Never put heavy items in the map pockets - risk of injury!

! CAUTION

Do not put any large items such as bottles or sharp objects into the map pockets, as the pockets and the seat covers could be damaged.

Glasses storage box

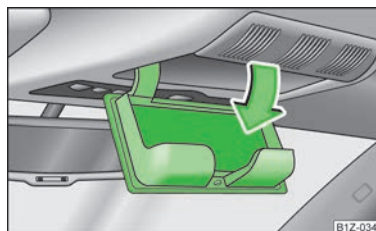

Fig. 75
Detail of the headliner: Glasses storage box

» Press on the cover of the glasses storage box, the compartment folds down » Fig. 75.

! WARNING

The compartment must only be opened when removing or inserting the spectacles and otherwise must be kept closed.

! CAUTION

Do not put any heat-sensitive objects in the glasses storage box - they may be damaged.

Storage compartments in the doors

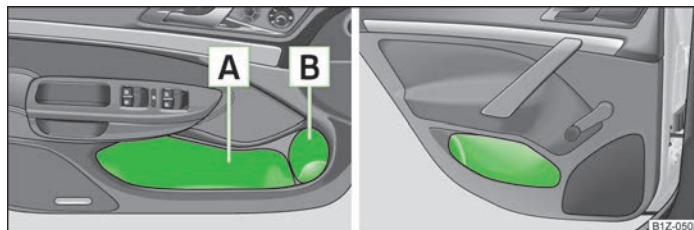

Fig. 76 Storage compartment: in the front door/in the rear door

A bottle holder is located in the area **B** » Fig. 76 of the storage compartment for the front doors.

! WARNING

Use the area **A** » Fig. 76 of the storage compartment only for storing objects which do not project so that the effectiveness of the side airbag is not impaired.

Stowage compartment below front passenger seat

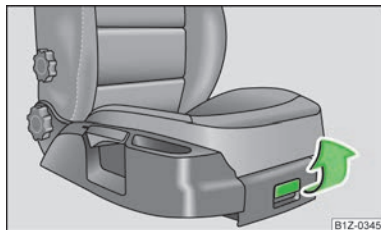

Fig. 77
Front passenger seat: Storage compartment

- To open the lid, pull the handle » Fig. 77.
- When closing the lid, hold the handle until the compartment is closed.

! WARNING

The storage compartment must always be closed when driving for safety reasons.

! CAUTION

The storage compartment is designed for storing small objects of up to 1.5 kg. in weight.

Front armrest with storage compartment

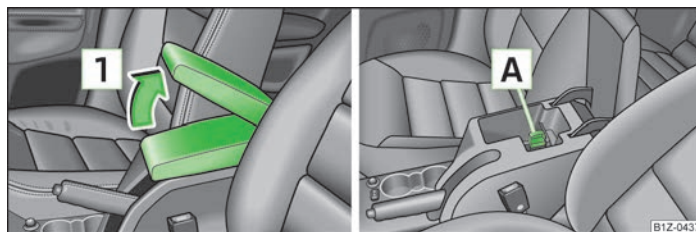

Fig. 78 Armrest: Storage compartment/cooling of storage compartment

The armrest is adjustable for height and length.

Opening the storage compartment

- Open the lid of the armrest in the direction of the arrow **1** » Fig. 78.

Closing storage compartment

- Open the lid to the stop, only then can it be folded downwards.

Setting height

- First of all fold the cover downwards and then lift it in the direction of the arrow **1** into one of the 4 fixed positions.

Adjusting in the forward/back direction

- Push the cover into the desired position.

Opening air inlet

- Pull the cover **A** upwards.

Closing air inlet

- Carefully push the cover **A** downwards as far as the stop.

On vehicles fitted with air conditioning, the storage compartment is equipped with a lockable inlet for thermally treated (warmed-up) air.

When the air vent is opened, the air flows into the stowage compartment with a temperature corresponding to the control dial settings on the A/C unit, depending on the outer climate conditions.

The air inlet in the storage compartment is connected to position  through adjustment of the control dial for air distribution. This setting causes the maximum amount of air to flow into the storage compartment (depending on the rotary regulator position for the fan).

The storage compartment can, for example, be used to temper drinks cans, etc.

If you do not use the air inlet in the storage compartment, the inlet should always be kept closed.

Note

Push the armrest cover all the way back to the stop before applying the hand-brake.

Rear armrest with storage compartment

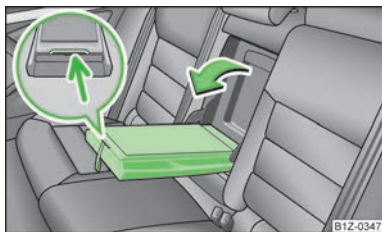

Fig. 79
The armrest at the rear

The armrest can be folded down to increase comfort.

The armrest includes a storage compartment. The compartment is opened by pressing the button on the front » Fig. 79 and raising the cover.

Stowage compartment in rear centre console

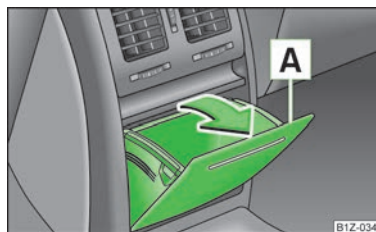



Fig. 80
Centre console at rear: Stowage compartment

The storage compartment is equipped with a removable insert.

» Open the storage compartment by pulling on the upper edge  in the direction of arrow » Fig. 80.

WARNING

The storage compartment is not a substitute for the ashtray and must also not be used for such purposes - risk of fire!

Seat backrest with through-loading channel

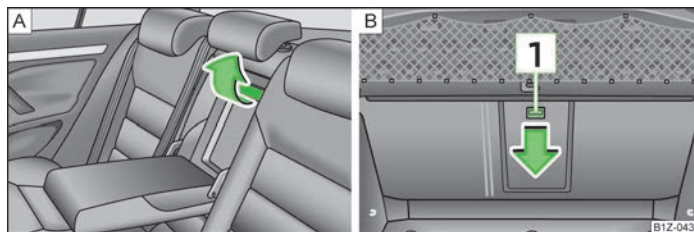

Fig. 81 Rear seats: Cover handle/boot: Unlock button

After folding the rear armrest and cover up, an opening in the seat backrest becomes visible through which the removable through-loading bag with skis can be pushed. The armrest and cover can be folded forward from the passenger compartment or the boot.

Opening from the passenger compartment

- You can fold down the armrest at the loop » [page 60](#).
- Pull the handle upwards to the stop » [Fig. 81](#) - **A** and fold the cover down.

Opening from the boot

- Push the unlock button **1** » [Fig. 81](#) - **B** down and fold the cover (including the armrest) forwards.

Closing

- Fold the cover and armrest upwards to the stop - the lid must click into place.

Ensure that the armrest is always locked into place after closing. This is apparent as the red field above the unlocking button **1** » [Fig. 81](#) - **B** is not visible from the luggage compartment.

! WARNING

The through-loading channel is only intended for transporting skis that are placed in a properly secured, removable through-loading bag » [page 76](#).

Removable through-loading bag

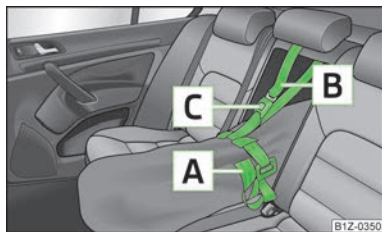

Fig. 82
Securing the through-loading bag

Loading

- Open the boot lid.
- Fold the rear armrest and the cover in the seat backrest downwards » [page 75](#), *Seat backrest with through-loading channel*.
- Place the empty, removable through-loading bag in such a way that the end of the bag with the zip is in the boot.
- Push the skis into the removable through-loading bag from the boot » **!**
- Close the through-loading bag.

Securing

- Tighten the strap **A** on the free end around the skis in front of the bindings » [Fig. 82](#).
- Fold the seat backrest a little forward.
- Guide the securing strap **B** through the opening in the seat backrest around the upper part of the seat backrest.
- Then push the seat backrest back into the upright position until the unlocking button clicks into place - check by pulling on the seat backrest.
- Insert the securing strap **B** into the lock **C** until it clicks into place.

On vehicles fitted with a luggage net partition, guide the securing strap **B** around the housing when the net partition is rolled up. After fixing the net partition in place, it is not longer possible to unroll the net partition.

! WARNING

- After placing skis into the through-loading bag, you must secure the bag with the securing strap **B** » [Fig. 82](#).
- The strap **A** must hold the skis tight.
- Make sure that the strap **A** holds the skis in front of the binding (also refer to imprint on the removable through-loading bag).
- The total weight of the skis which are transported must not exceed 17 kg.

i Note

- The through-loading bag is foreseen for four pairs of skis.
- Place the skis and sticks in the removable through-loading bag with the tips facing to the rear.
- If there are several pairs of skis in the removable through-loading bag, ensure that the bindings are positioned at the same height.
- The removable through-loading bag must never be folded together or stowed when moist.

Side compartment in the luggage compartment

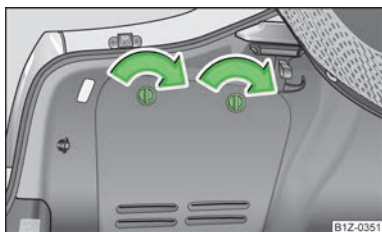

Fig. 83
Boot: Side compartment

- The compartment is opened by turning the locks in the direction of the arrow » Fig. 83.

The CD changer is housed in this compartment.

Stowage compartment behind the rear seats (Estate car)

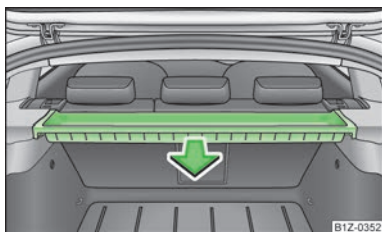

Fig. 84
Removing the stowage compartment

Removing

- First of all, remove the foldable luggage compartment cover » page 64.
- Grab the housing with both hands and remove by pulling in the direction of the arrow » Fig. 84.

Install

- Move the housing into the locking mechanism as far as it will go.
- Restore the foldable luggage compartment cover.

! WARNING

Only place small and light objects up to a total weight of 3 kg into the storage compartment. In the event of a vehicle collision heavy objects could be thrown out of the compartment - risk of injuries! For this reason, the front part of the luggage compartment cover must always cover over the storage compartment.

Clothes hooks

The clothes hooks are located on the middle pillar and on the handle of the headliner above each of the rear doors.

! WARNING

- Ensure that any clothes hanging from the hooks do not impair your vision to the rear.
- Only use the hooks for hanging light items of clothing and ensure that there are no heavy or sharp-edged objects in the pockets.
- Do not use clothes hangers for hanging up items of clothing otherwise this may reduce the effectiveness of head airbags.

! CAUTION

The maximum permissible load of the hooks is 2 kg.

Parking ticket holder

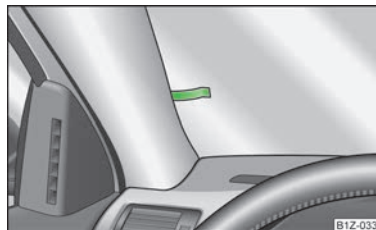

Fig. 85
Windscreen: Parking ticket holder

The note holder is designed e.g. for attaching car park tickets.

 **WARNING**

The attached note has to always be **removed** before starting off in order not to restrict the driver's vision. ■

Heating and air conditioning system

Heating and air conditioning system

Introductory information

The heating effect is dependent upon the coolant temperature, thus full heat output only occurs when the engine has reached its operating temperature.

If the cooling system is switched on, the temperature and air humidity drops in the vehicle. The well-being of the occupants of the car is enhanced as a result of this particularly at high outside temperatures and a high air humidity. The system prevents the windows misting up during the cold season of the year.

It is possible to briefly activate recirculated air mode to enhance the cooling effect.

Please refer to the information regarding recirculated air mode for the air-conditioning system » [page 84](#) or for Climatronic » [page 86](#).

The air inlet in front of the windscreen must be free of ice, snow or leaves to ensure that the heating and cooling system operates properly.

After switching on the cooling **Condensation** from the evaporator of the air conditioning may drip down and form a puddle below the vehicle. This is quite normal and not an indication of a leak!

WARNING

- For your own safety and that of other road users, ensure that all the windows are free of ice, snow and misting. Please familiarize yourself about how to correctly operate the heating and ventilation systems, how to demist and defrost the windows, as well as with the cooling mode.
- Do not leave recirculated air mode on over a longer period of time, as "stale" air can cause fatigue of the driver and passengers, reduce attention levels and also cause the windows to mist up. The risk of having an accident increases. Switch off recirculated air mode as soon as the windows start to mist up.

Note

- The used air streams out through the vents in the boot.
- We recommend that you do not smoke in the vehicle when the recirculating air mode is operating since the smoke which is drawn at the evaporator from the interior of the vehicle forms deposits in the evaporator of the air conditioning system. This produces a permanent odour when the air conditioning system is operating which can only be eliminated through considerable effort and expense (replacement of compressor).
- To ensure that the heating and air conditioning systems work properly, do not block up the air outlet vents with any objects.

Using the air conditioning system economically

The compressor on the air conditioning system uses power from the engine when in cooling mode which will effect the fuel consumption.

It recommended to open the windows or the doors of a vehicle for which the interior has been strongly heated through the effect of direct sunlight in order to allow the heated air to escape.

The cooling system should not be switched on while travelling when the window is open.

If the desired interior temperature can also be achieved without activating the cooling system, fresh air mode should be selected.



For the sake of the environment

Pollutant emissions are also reduced when fuel is saved.

Operational problems

If the cooling system does not operate at outside temperatures higher than +5 °C, there is a problem in the system. The reasons for this may be.

- One of the fuses has blown. Check the fuse and replace if necessary » [page 190](#).
- The cooling system has switched off automatically for a short time because the coolant temperature of the engine is too hot » [page 9](#).

If you cannot rectify the functional fault yourself, or the cooling capacity decreases, the cooling system must be switched off. Visit a ŠKODA specialist garage.

Air outlet vents

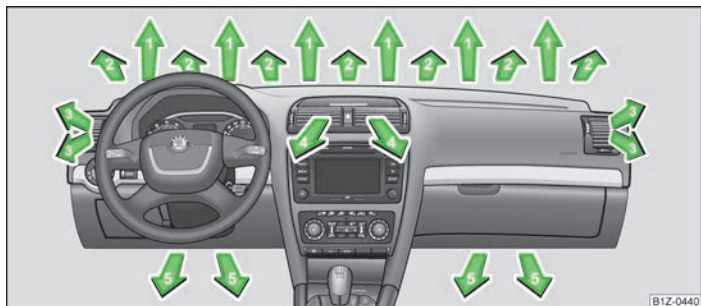

Fig. 86 Air vents at the front

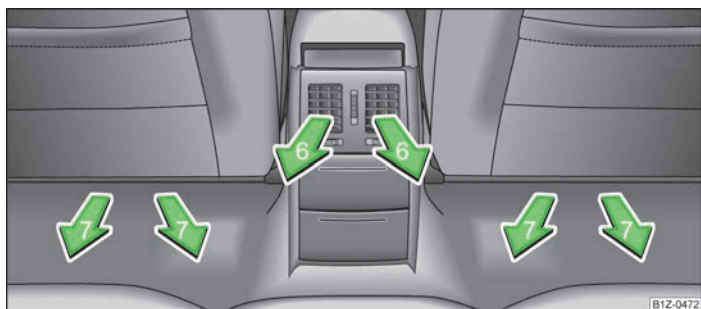

Fig. 87 Air vents at the rear

Opening

- Turn the vertical wheel » Fig. 86 (not into the end position).

Closing

- Turn the vertical wheel » Fig. 86 into the end position.

Changing the air flow direction

- Swivel upward or downward the grille of the vents in order to change the direction of the air flow using the vertically arranged thumbwheel » Fig. 86.
- Turn the horizontal thumbwheel on the vent to the right or left in order to change the air flow to the appropriate side. The thumbwheels are located on the air outlet vents 3, 4 » Fig. 86 and 6 » Fig. 87.

The air outlet vents 3, 4 » Fig. 86 and 6 » Fig. 87 can be closed and opened individually.

The air outlet vents 6 » Fig. 87 are only fitted on vehicles with the higher centre console.

Warmed, unwarmed or cooled air will flow out of the air outlet vents according to the setting of the regulator of the heating or the air conditioning system and the atmospheric conditions.

i Note

The air outlet vents 2 » Fig. 86 ensure in the ventilation and cooling mode for a comfortable (no-draught) ventilation of the interior of the vehicle, also if the air outlet vents 4 » Fig. 86 are closed.

Heating

Using the system

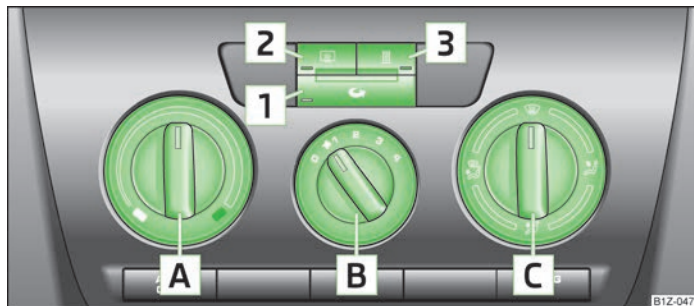

Fig. 88 Heating: Control elements

Setting temperature

- Turn the control dial **A** » Fig. 88 to the right to increase the temperature.
- Turn the control dial **A** to the left to decrease the temperature.

Controlling blower

- Turn the blower switch **B** » Fig. 88 into one of the positions, 1 to 4, to switch the blower on.
- Turn the blower switch **B** into position 0 to switch the blower off.
- If you wish to shut off the fresh air supply, use the button **1** » page 82, **i** in section *Recirculated air mode*.

Regulating the air distribution

- The direction of the inlet air flow is controlled with air distribution regulator **C** » Fig. 88 » page 80.

Rear window heater

- Press the button **Z** » Fig. 88. Further information » page 47.

Auxiliary heating (parking heating)

- Press the button **3** » Fig. 88 to directly switch on/off the auxiliary heating (auxiliary heating and ventilation). Further information » page 87.

All controls apart from the blower switch **B** » Fig. 88 can be set to any desired intermediate position.





The blower should always be on to prevent the windows from misting up.

i Note

If the air distribution is positioned towards the windows, the total amount of air is used to defrost the windows and thus no air will be fed to the footwell. This can lead to restriction of the heating comfort.

Set heating

Recommended basic settings of the heating controls for the respective operating modes:

Set-up	Setting of the control dial			Button 1	Air outlet vents 3
	A	B	C		
Defrosting the windshield and side windows	To the right up to the stop	3		Do not switch on	Open and align with the side window
Free windshield and side windows from mist	Desired temperature	2 or 3		Do not switch on	Open and align with the side window
The fastest heating	To the right up to the stop	3		Briefly switch on	Opening
Comfortable heating	Desired temperature	2 or 3		Do not switch on	Opening
Fresh air mode - ventilation	To the left up to the stop	Desired position		Do not switch on	Opening

i Note

- Controls **A** » Fig. 88 on page 80, **B**, **C** and the button **1**.
- Air outlet vents **3** » Fig. 86 on page 80.
- We recommend that you leave the air outlet vents **4** » Fig. 86 on page 80 in the opened position.

Recirculated air mode

Recirculated air mode prevents polluted air outside the vehicle from getting into the vehicle, for example when driving through a tunnel or when standing in a traffic jam.

Switching on

- Press the button **1** » Fig. 88 on page 80 and the warning light in the button illuminates.

Switching off

- Press the button **1** » Fig. 88 on page 80 again - the warning light in the button goes out.

Recirculated air mode is switched off automatically if the air distribution control **C** » Fig. 88 on page 80 is in position . Recirculated air mode can be switched on again from this setting by repeatedly pressing the button **1**.

! WARNING

Do not leave recirculated air mode on over a longer period of time, as "stale" air can cause fatigue of the driver and passengers, reduce attention levels and also cause the windows to mist up. The risk of having an accident increases. Switch off recirculated air mode as soon as the windows start to mist up.

Air conditioning system (manual air conditioning system)

Introductory information

The cooling system only operates if the button **AC 1** » Fig. 89 on page 82 is pressed, and the following conditions are met:

- engine running;
- outside temperature above approx. +2 °C;
- blower switch switched on (positions 1 to 4).

Under certain circumstances, air at a temperature of about 5 °C can flow out of the vents when the cooling system is switched on. Lengthy and uneven distribution of the air flow out of the vents and large differences in temperature, for example when getting out of the vehicle, can result in chills in sensitive persons.

i Note

We recommend that you have the air conditioning system cleaned by a ŠKODA specialist garage once every year.

Using the system

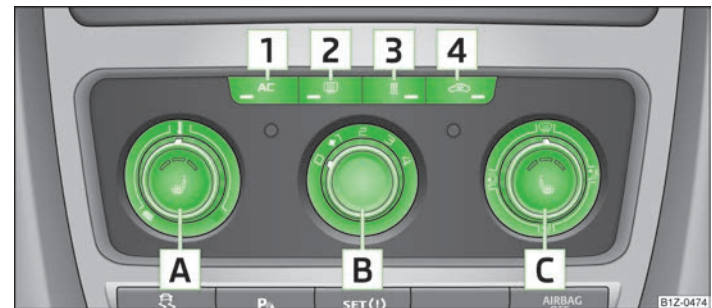



Fig. 89 The air conditioning system: Control elements

Setting temperature

- › Turn the control dial **A** » Fig. 89 to the right to increase the temperature.
- › Turn the control dial **A** to the left to decrease the temperature.

Controlling blower

- › Turn the blower switch **B** » Fig. 89 into one of the positions, 1 to 4, to switch the blower on.
- › Turn the blower switch **B** into position 0 to switch the blower off.
- › Press the button  **4** to close the fresh air supply » Fig. 89.

Regulating the air distribution

- › The direction of the inlet air flow is controlled with air distribution regulator **C** » Fig. 89 » page 80.

Switching the cooling system on and off

- › Press the button **AC** **1** » Fig. 89 and the warning light in the button illuminates.
- › When you again press the button **AC**, the air conditioning system is switched off. The warning light in the button goes out.

Rear window heater

- › Press the button  **2** » Fig. 89. Further information » page 47.

Auxiliary heating (parking heating)

- › Press the button  **3** » Fig. 89 to directly switch on/off the auxiliary heating (auxiliary heating and ventilation). Further information » page 87.

Note

- The whole heat output will be needed to defrost the windscreen and side windows. No warm air will be fed to the footwell. This can lead to restriction of the heating comfort.
- The warning light **AC** lights after activation, even if not all of the conditions for the function of the cooling system have been met » page 82, *Introductory information*. By lighting up of the warning light in the button, the operational readiness of the cooling system is signalled. ■

Setting the air conditioning system

Recommended basic settings of the control elements of the air conditioning system for the respective operating modes:

Set-up	Setting of the control dial			Button		Air outlet vents 3
	A	B	C	1	4	
Defrost/defog windscreen and side windows ^{a)}	Desired temperature	3 or 4		Automatically switched on	Do not switch on	Open and align with the side window
The fastest heating	To the right up to the stop	3		Switched off	Briefly switch on	Opening
Comfortable heating	Desired temperature	2 or 3		Switched off	Do not switch on	Opening
The fastest cooling	To the left up to the stop	briefly 4, then 2 or 3		Activated	Briefly switch on	Opening
Optimal cooling	Desired temperature	1, 2 or 3		Activated	Do not switch on	Open and align to the roof
Fresh air mode - ventilation	To the left up to the stop	Desired position		Switched off	Do not switch on	Opening

^{a)} We recommend that you do not use this setting in countries with high humidity levels. This can result in heavy cooling of the window glass and the following fogging from outside.

Note

- Controls **A** » Fig. 89 on page 82, **B**, **C** and buttons **1** and **4**.
- Air outlet vents **3** » Fig. 86 on page 80.
- We recommend that you leave the air outlet vents **4** » Fig. 86 on page 80 in the opened position.

Recirculated air mode

Recirculated air mode prevents polluted air outside the vehicle from getting into the vehicle, for example when driving through a tunnel or when standing in a traffic jam.

Switching on

- Press the button **4** » Fig. 89 on page 82 and the warning light in the button illuminates.

Switching off

- Press the button **4** » Fig. 89 on page 82 again - the warning light in the button goes out.

Recirculated air mode is switched off automatically if the air distribution control **C** » Fig. 89 on page 82 is turned to position . Recirculated air mode can be switched on again from this setting by repeatedly pressing the button .

WARNING

Do not leave recirculated air mode on over a longer period of time, as "stale" air can cause fatigue of the driver and passengers, reduce attention levels and also cause the windows to mist up. The risk of having an accident increases. Switch off recirculated air mode as soon as the windows start to mist up.

Climatronic (automatic air conditioning system)

Introductory information

The Climatronic maintains fully automatically a convenience temperature. This is achieved by automatically varying the temperature of the air flow, the blower stages and air distribution. The system also takes sunlight into account, which eliminates the need to alter the settings manually. The **automatic mode** » page 86 ensures maximum well-being of the occupants at all times of the year.

Description of Climatronic system

The cooling system only operates if the following conditions are met:

- > engine running;
- > outside temperature above approx. +2 °C;
- > (AC) [13] » Fig. 90 on page 85 switched on.

The AC compressor is switched off at a high coolant temperature in order to provide cooling at a high load of the engine.

Recommended setting for all periods of the year.

- > Set the desired temperature, we recommend 22 °C.
- > Press the button (AUTO) [8] » Fig. 90 on page 85.
- > Move the air outlet vents 3 » Fig. 86 on page 80 and 4 so that the air flow is directed slightly upwards.

i Note

- We recommend that you have the Climatronic system cleaned by a ŠKODA specialist garage once every year.
- On vehicles equipped with a factory-fitted radio or radio navigation system, the Climatronic information is also shown on their displays. This function can be switched off, see operating instructions for the radio or navigation system.

Overview of the control elements

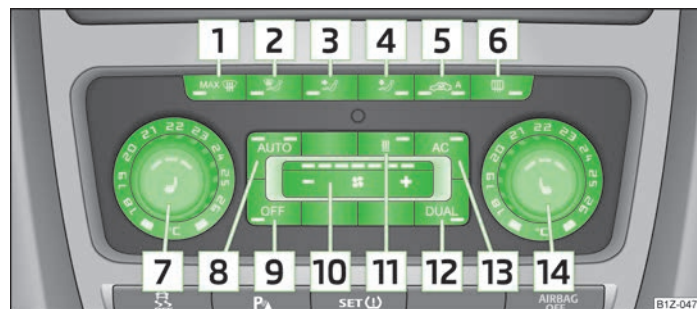

Fig. 90 Climatronic: Control elements

The buttons

- 1 Defrost windscreen intensively (MAX)
- 2 Air flow to the windows (2)
- 3 Air flow to head (2)
- 4 Air flow in the footwell (2)
- 5 Recirculated air mode (A) with air quality sensor
- 6 Rear window heater (R)

The buttons/control dial

- 7 Setting of the temperature for the left side, operation of the seat heating of the left front seat
- 8 Automatic mode (AUTO)
- 9 Switching off Climatronic (OFF)
- 10 Setting the blower speed (F)
- 11 Button for direct switching on/off of auxiliary heating (H) » Fig. 91 on page 88
- 12 Switching on/off of the temperature setting in dual mode (DUAL)
- 13 Switching the cooling system on and off (AC)
- 14 Setting of the temperature for the right side, operation of the seat heating of the right front seat

i Note

Below the top row of buttons is located the interior temperature sensor. Do not stick anything on or cover the sensor, otherwise it could have an unfavourable effect on the Climatronic.

Automatic mode

The automatic mode is used in order to maintain a constant temperature and to demist the windows in the interior of the car.

Switching on

- Set a temperature between +18 °C and +26 °C.
- Move the air outlet vents **3** » Fig. 86 on page 80 and **4** so that the air flow is directed slightly upwards.
- Press the button (AUTO) **8** » Fig. 90 on page 85. The warning light in the top right or left corner lights up, depending on which mode was last selected.

If the warning light in the top right corner of the button (AUTO) **8** » Fig. 90 on page 85 lights up, the Climatronic operates in "HIGH" mode. The "HIGH" mode is the standard setting of the Climatronic.

When pressing again the button (AUTO), the Climatronic changes into the "LOW" mode and the warning light in the top left corner lights up. The Climatronic uses only in this mode the lower blower speed. However taking into account the noise level, this is more comfortable, yet be aware that the effectiveness of the air conditioning system is reduced particularly if the vehicle is fully occupied.

By pressing the button (AUTO) again, it is changed to "HIGH" mode.

Automatic mode is switched off by pressing one of the buttons for the air distribution or by increasing/decreasing the blower speed. The temperature is nevertheless regulated.

Switching the cooling system on and off

Switching the cooling system on and off

- Press the button (AC) **13** » Fig. 90 on page 85. The warning light in the button lights up.
- When you again press the button (AC) **13**, the air conditioning system is switched off. The warning light in the button goes out. Only the function of the ventilation remains active when no lower temperature than the outside temperature can be reached.

Setting temperature

The interior temperature for the left and right side can be set separately.

- The temperature for both sides can be set with the control dial **7** » Fig. 90 on page 85 after switching on the ignition.
- If you wish to set the temperature for the right side, turn the control dial **14** » Fig. 90 on page 85. The warning light in the button (DUAL) **12** » Fig. 90 on page 85 lights up, this indicates that differing temperatures for the left and right side can be set.

If the warning light in the button (DUAL) **12** » Fig. 90 on page 85 is illuminated, the temperature for both sides cannot be set with the control dial **7** » Fig. 90 on page 85. You can reactivate this function by pressing the button (DUAL) **12**. The warning light in the button goes out.

The interior temperature can be set between +18 °C and +26 °C. The interior temperature is regulated automatically within this range. If a temperature lower than +18 °C is selected, a blue symbol lights up at the start of the numerical scale. If a temperature higher than +26 °C is selected, a red symbol lights up at the start of the numerical scale. In both limit positions the Climatronic operates at maximum cooling or heating capacity, respectively. The temperature is not controlled in this case.

Lengthy and uneven distribution of the air flow out of the vents (especially around the feet) and large differences in temperature, for example, when getting out of the vehicle, can cause susceptible individuals to catch a cold.

Recirculated air mode

Recirculated air mode largely prevents polluted air from outside the vehicle getting into the vehicle, for example, when driving through a tunnel or when standing in a traffic jam. If a considerable increase in concentration of pollutants is recognized by the air quality sensor, when the automatic air distribution control is switched on, the air distribution control will temporarily be switched off. If the concentration of pollutants decreases to the normal level, the air distribution control is automatically switched off so that fresh air can be guided into the vehicle interior. In recirculated air mode air is sucked out of the interior of the vehicle and then fed back into the interior. When the automatic air distribution control is switched on, an air quality sensor measures the concentration of pollutants in the drawn in air.

Switching recirculated air mode on

➤ Repeatedly press the button  **5** » Fig. 90 on page 85 until the warning light on the left side of the button is illuminated.



Switch on automatic air distribution control

➤ Repeatedly press the button  **5** » Fig. 90 on page 85 until the warning light on the right side of the button is illuminated.

Switch off automatic air distribution control temporarily

➤ If the air quality sensor does not automatically switch on the air distribution control in the event of an unpleasant odour, you can switch it on yourself by pressing the button  **5** » Fig. 90 on page 85. The warning light lights up in the button on the left side.



Switching recirculated air mode off

➤ Press the button  **8** » Fig. 90 on page 85 or repeatedly press the button  **5** » Fig. 90 on page 85 until the warning lights in the button go out.

! WARNING

Do not leave recirculated air mode on over a longer period of time, as "stale" air can cause fatigue of the driver and passengers, reduce attention levels and also cause the windows to mist up. The risk of having an accident increases. Switch off recirculated air mode as soon as the windows start to mist up.

i Note

- If the windscreen mists up, press the button  **1** » Fig. 90 on page 85. Press the button  **8** » Fig. 90 on page 85 when the windshield is demisted.
- The automatic air distribution control operates only if the outside temperature is higher than approx. 2 °C.

Controlling blower

The Climatronic system controls the blower stages automatically in line with the interior temperature. However, the blower stages can be manually adapted to suit your particular needs.

➤ Repeatedly press the button  **10** » Fig. 90 on page 85 on the left side (reduce blower speed) or on the right side (increase blower speed).

If the blower is switched off, the Climatronic system is switched off.

The set blower speed is displayed above the button  **10** » Fig. 90 on page 85 when the respective number of warning lights come on.

! WARNING

- "Stale air" may result in fatigue in the driver and occupants, reduce attention levels and also cause the windows to mist up. The risk of having an accident increases.
- Do not switch off the Climatronic system for longer than necessary.
- Switch on the Climatronic system as soon as the windows mist up.

Defrosting windscreen

Switching on

➤ Press the button  **1** » Fig. 90 on page 85.

Switching off

➤ Once again press the button  **1** » Fig. 90 on page 85 or the button .

The temperature control is controlled automatically. More air flows out of the air outlet vents **1** » Fig. 86 on page 80.

Auxiliary heating (auxiliary heating and ventilation)

Introduction

This chapter contains information on the following subjects:

Direct switching on/off	88
System settings	89
Radio remote control	89
Changing the battery of the radio remote control	90

Auxiliary heating (parking heating)

The auxiliary heater (parking heater) functions in connection with the air-conditioning system or Climatronic.

It can be used when stationary, when the engine is switched off to preheat the vehicle and while driving (e.g. during the heating phase of the engine).

The engine is also preheated, if the auxiliary heating is switched on when the vehicle is stationary and the engine is switched off.

The auxiliary heating (parking heating) warms up the coolant by combusting fuel from the vehicle tank. The coolant warms up the air, which (if the blower speed is not set to zero) flows into the passenger compartment.

Auxiliary ventilation



The auxiliary ventilation enables fresh air to flow into the vehicle interior by switching off the engine, whereby the interior temperature is effectively decreased (e.g. with the vehicle parked in the sun).

! WARNING

- The auxiliary heating must never be operated in closed rooms - risk of poisoning!
- The auxiliary heating must not be running during refuelling - risk of fire.
- The exhaust pipe of the auxiliary heating is located on the underside of the vehicle. Therefore, if you wish to operate the auxiliary heating, do not park the vehicle in such a way that the exhaust gases from the auxiliary heating can come into contact with highly flammable materials (e.g. dry grass) or easily inflammable substances (e.g. spilt fuel).

i Note

- If the auxiliary heating runs, the fuel consumption comes from the vehicle tank. The auxiliary heating automatically controls the filling level in the fuel tank. If only a low quantity of fuel is present in the fuel tank, the function of the auxiliary heating is blocked.
- The exhaust pipe of the auxiliary heating, which is located on the underside of the vehicle, must not be clogged and the exhaust flow must not be blocked.
- If the auxiliary heating and ventilation is running, the vehicle battery discharges. If the auxiliary heating and ventilation has been operated several times over a longer period, the vehicle must be driven a few kilometres in order to recharge the vehicle battery.
- The auxiliary heating only switches the blower on, if it has achieved a coolant temperature of approx. 50 °C.
- At low outside temperatures, this can result in a formation of water vapour in the area of the engine compartment. This is quite normal and is not an operating problem.
- After switching off the auxiliary heating, the coolant pump runs for a short period.
- The auxiliary heating and ventilation does not switch on or comes on, if the vehicle battery indicates a low loading state » [page 169, Automatic load deactivation](#).

- The auxiliary heating (parking heating) does not switch on, if the following was shown in the information display or before switching off the ignition: **Please refuel!**
- The air inlet in front of the windscreen must be free of ice, snow or leaves in order to ensure that the auxiliary heating operates properly.
- So that warm air can flow into the vehicle interior after switching on the auxiliary heating, you must maintain the comfort temperature normally selected by you, leave the fan switched on and leave the air outlet vents in an open position. It is recommended to put the air flow in the position  or .

Direct switching on/off



Fig. 91
Button for direct switching on/off of the auxiliary heating (auxiliary heating and ventilation) on the operating part of the air conditioning system



First read and observe the introductory information and safety warnings  on page 87.

The auxiliary heating (auxiliary heating and ventilation) can be **directly** switched on or off at any time using the button  » [Fig. 91](#) on the operating part of the air-conditioning system, on the operating part of the Climatronic system or via the radio remote control » [page 89](#).

If the auxiliary heating and ventilation is not switched off earlier, it switches off automatically after the set operating period, in the menu **Running time** has expired.

System settings

 First read and observe the introductory information and safety warnings  on page 87.

The following menu items can be selected in the menu **Aux. heating** in the information display (depending on the equipment fitted in the vehicle):

- **Day of the wk.** - Set the current weekday.
- **Time** - Set the desired running time in 5 minute increments. The running time can be 10 to 60 minutes.
- **Mode** - Set the desired heating/ventilation mode.
- **Starting time 1-3** - In each pre-set time, the day and the time (hour and minute) can be set for switching on the auxiliary heating and/or ventilation. An empty position can be found between Sunday and Monday when selecting the day. If this empty position is selected, the activation is performed without taking into account the day.
- **Activate** - Enable pre-set mode.
- **Dectivate** - Disable pre-set mode.
- **Factory setting** - Restore factory setting.
- **Back** - Return to main menu.

Only one programmed pre-set time can be active.

The last programmed pre-set time remains active.

After the auxiliary heating activates at the set time, it is necessary to pre-set a time again.

If the pre-set menu is closed by selecting the menu item **Back** or if no changes are made on the display for more than 10 seconds, the set values are stored, but the pre-set time is not activated.

An warning light on the button  » Fig. 91 on page 88 is illuminated when the system is running.

The running system deactivates after expiration of the operating period or can be deactivated earlier by pressing the button to directly switch on/off the auxiliary heating  » Fig. 91 on page 88 or by using the radio remote control. ■

Radio remote control

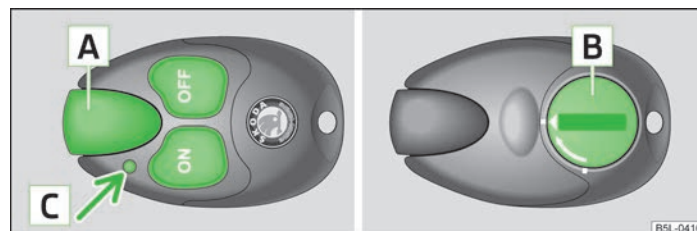





Fig. 92 Auxiliary heating: Radio remote control

 First read and observe the introductory information and safety warnings  on page 87.

- For switching on, press the button  » Fig. 92.
- For switching off, press the button .

The transmitter and the battery are housed in the housing of the remote control. The receiver is located in the interior of the vehicle.

If the battery is properly charged, the effective range is up to 600 m. To switch on/off the auxiliary heating, hold the radio remote control vertically with the antenna  » Fig. 92 facing upwards. The antenna must not be covered with the fingers or the palm of the hand during this process. Obstacles between the radio remote control and the vehicle, bad weather conditions and a weaker battery can clearly reduce the range.

The auxiliary heating can only be switched on/off safely using the radio remote control, if the distance between the radio remote control and the vehicle is at least 2 m.

Warning light in the radio remote control

The warning light in the radio remote control  » Fig. 92 indicates after a key-stroke if the remote control signal was received by the auxiliary heating and if the battery is adequately charged.



Display warning light	Importance
Lights up green for 2 seconds.	The auxiliary heating was switched on.
Lights up red for 2 seconds.	The auxiliary heating was switched off.
Slowly flashes green for 2 seconds.	The ignition signal was not received. ▶



Display warning light	Importance
Quickly flashes green for 2 seconds.	The auxiliary heating is blocked, e. g because the tank is nearly empty or there is a fault in the auxiliary heating.
Flashes red for 2 seconds.	The switch off signal was not received.
Lights up orange for 2 seconds, then green or red.	The battery is weak, however the switching on or off signal was received.
Lights up orange for 2 seconds, then flashes green or red.	The battery is weak, however the switching on or off signal was not received.
Flashes orange for 5 seconds.	The battery is discharged, however the switching on or off signal was not received.

CAUTION

The radio remote control comprises electronic components and must therefore be protected against water, severe impacts and direct sunlight. ■

Changing the battery of the radio remote control

 First read and observe the introductory information and safety warnings  on page 87.

If the warning light on the radio remote control indicates a weak or discharged battery,  » Fig. 92 on page 89, it must be replaced. The battery is located under a cover  » Fig. 92 on page 89 on the back of the radio remote control.

- Insert a flat, blunt object, such as a coin, into the gap on the battery cover, turn the cover in the opposite direction of the arrow up to the mark and unlock it.
- Change the battery, replace the battery cover and lock it by moving it in the direction of the arrow.

For the sake of the environment

Dispose of the old battery in accordance with environmental regulations.

Note

- Pay attention to the correct polarity when changing the battery.
- The replacement battery must have the same specification as the original battery. ■

Starting-off and Driving

Starting and stopping the engine

Introduction

This chapter contains information on the following subjects:

Adjusting the steering wheel position _____	92
Electromechanical power steering _____	92
Electronic immobiliser _____	92
Ignition lock _____	93
Starting engine _____	93
Switching the engine off _____	93

WARNING

- Never adjust the steering wheel when the vehicle is moving only when the vehicle is stationary!
- Maintain a distance of 25 cm **1** to the steering wheel » Fig. 93 on page 92 - **2**. Not maintaining this minimum distance will mean that the airbag system will not be able to properly protect you - hazard!
- The lever for adjusting the steering wheel must be locked whilst driving so that the position of the steering wheel cannot accidentally change during the journey - risk of accident!
- If the steering wheel is adjusted further towards the head, the protection provided by the driver airbag in the event of an accident is reduced. Check that the steering wheel is aligned to the chest.
- When driving, hold the steering wheel with both hands firmly on the outer edge in the 9 o'clock and 3 o'clock position. Never hold the steering wheel in the 12 o'clock position or in any other way (e.g. in the middle or inner edge of the steering wheel). In such cases, you could injure the arms, hands and head when the driver airbag is deployed.
- When driving, the ignition key must always be in the position **2** » Fig. 94 on page 93 (ignition switched on) without the engine running. This position is indicated by the warning lights coming on. If this is not the case, it could result in unexpected locking of the steering wheel - risk of accident!

WARNING (Continued)

- Only pull the ignition key from the ignition lock when the vehicle has come to a complete stop (by applying the handbrake). Otherwise the steering wheel could block - risk of accident!
- When leaving the vehicle, the ignition must always be removed. This is particularly important if children are left in the vehicle. Otherwise the children could, for example, start the engine - risk of accident or injury!
- Never leave the engine running in unventilated or closed rooms. The exhaust gases of the engine contain besides the odorless and colourless carbon monoxide a poisonous gas - hazard! Carbon monoxide can cause unconsciousness and death.
- Never leave the vehicle unattended with the engine running.
- Never switch off the engine before the vehicle is stationary - risk of accident!

CAUTION

- The starter may only be operated (ignition key position **3** » Fig. 94 on page 93), if the engine is not running. The starter or engine can be damaged if the starter is activated when the engine is running.
- Let go of the ignition key as soon as the engine starts otherwise the starter could be damaged.
- Avoid high engine revolutions, full throttle and high engine loads as long as the engine has not yet reached its operating temperature - risk of damaging the engine!
- Do not tow start the engine - danger of damaging the engine! On vehicles with a catalytic converter, unburnt fuel may get into the catalytic converter where it may ignite. This in turn may damage the catalytic converter. The battery from another vehicle can be used as a jump-start aid » page 185, *Jump-starting*.
- Do not switch the engine off immediately at the end of your journey after the engine has been operated over a prolonged period at high loads but leave it to run at an idling speed for about 1 minute. This prevents any possible accumulation of heat when the engine is switched off.

For the sake of the environment

Do not warm up the engine while the vehicle is stationary. If possible, start your journey as soon as the engine has started. Through this the engine reaches its operating temperature more rapidly and the pollutant emissions are lower. ▶

i Note

- The engine can only be started with a genuine ŠKODA key with the matching code.
- The engine running noises may louder at first be louder for a short time after starting the cold engine. This is quite normal and is not an operating problem.
- After switching off the ignition, the radiator fan can intermittently continue to operate for approx. 10 minutes.
- If the engine does not start up after a second attempt, the fuse for the fuel pump/glow plug system (Diesel engines) may have a fault. Check the fuse and replace, if necessary » [page 190](#), *Fuses in the dash panel* or seek assistance from a ŠKODA specialist garage.
- We recommend **locking the steering wheel** whenever leaving the vehicle. This acts as a deterrent against the attempted theft of your car.

Adjusting the steering wheel position

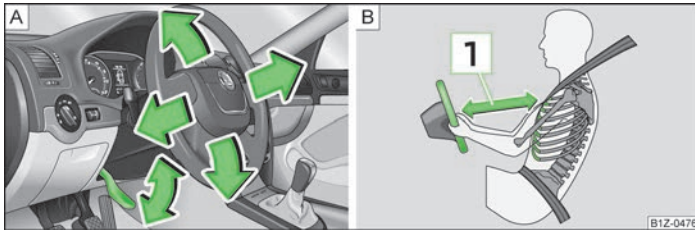



Fig. 93 Adjustable steering wheel: Lever below the steering wheel/safe distance to the steering wheel

 First read and observe the introductory information and safety warnings  on page 91.

- The height and forward/back position of the steering wheel can be adjusted.
- First of all adjust the driver's seat » [page 55](#), *Manually adjusting the front seats*.
 - Pull the lever below the steering wheel down » [Fig. 93 - A](#).
 - Adjust the steering wheel to the desired position (with regard to the height and forward/back position).
 - Push the lever upwards to the stop.



Electromechanical power steering

 First read and observe the introductory information and safety warnings  on page 91.

The power steering enables you to steer the vehicle with less physical force.

With the electromechanical power steering, the steering assist is automatically adapted to the speed and to the steering angle.

It is still possible to fully steer the vehicle if the power steering fails or if the engine is not running (vehicle being towed in). However, greater physical effort is required to turn the steering wheel.

If there is a fault in the power steering, the warning light  or  lights up in the instrument cluster » [page 21](#), *Electromechanical power steering* .

Electronic immobiliser

 First read and observe the introductory information and safety warnings  on page 91.

An electronic chip is integrated in the head of the key. The immobiliser is deactivated with the aid of this chip when the key is inserted in the ignition lock. The electronic immobiliser is automatically activated when the ignition key is withdrawn from the lock.

The engine will not start if a non-authorized ignition key is used.

The following is displayed in the information display:

Immobilizer active.

Ignition lock

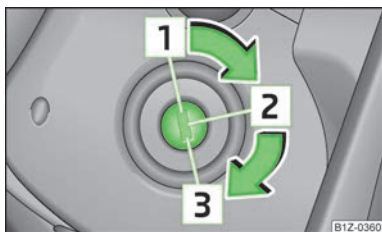

Fig. 94
Positions of the vehicle key in the ignition lock

First read and observe the introductory information and safety warnings on page 91.

Petrol engines

- 1 Ignition switched off, engine off, the steering can be locked
- 2 Ignition switched on
- 3 Starting engine

Diesel engines

- 1 Fuel supply interrupted, ignition switched off, engine switched off, the steering can be locked.
- 2 Heating glow plugs on, ignition switched on
- 3 Starting engine

To **lock the steering**, with the ignition key withdrawn, turn the steering wheel until the steering locking pin engages audibly.

If the **steering is locked** and the key cannot or can only be turned with difficulty into the position » Fig. 94, move the steering wheel back and forth and the steering lock will unlock.

Starting engine

First read and observe the introductory information and safety warnings on page 91.

Vehicles with a **diesel engine** are equipped with a glow plug system. The pre-glow warning light comes on after the ignition has been switched on. The engine should be started immediately after the preglow warning light goes out.

You should not switch on any major electrical components during the heating period otherwise the vehicle battery will be drained unnecessarily.

Procedure for starting the engine

- Before starting the engine, place the gearshift lever into neutral or place the selector lever in the position **P** or **N** and firmly put on the handbrake.
- Fully depress and hold the clutch pedal, switch on the ignition » Fig. 94 on page 93 and start - do not operate the accelerator. Depress the clutch pedal until the engine starts.
- Let go of the key as soon as the engine starts. After letting go, the vehicle key will return to position .
- If the engine does not start within 10 seconds, abort the start-up process and turn the key to position . Repeat the start-up process after approx. half a minute.
- Release the handbrake before starting off.

The engine will not start if the clutch pedal is not depressed.

The following is displayed in the information display:

Depress clutch to start!

The following is shown in the information display of the information cluster:

CLUTCH

Switching the engine off

First read and observe the introductory information and safety warnings on page 91.

Switch off the engine by turning the ignition key into position » Fig. 94 on page 93.

Brakes and brake assist systems

Introduction

This chapter contains information on the following subjects:

Information for braking	94
Handbrake	95
Stabilisation Control (ESC)	95 ▶

Antilock brake system (ABS) _____	96
Traction control system (TCS) _____	96
Electronic Differential Lock (EDS and XDS) _____	97

WARNING

- The brake booster only operates when the engine is running. Greater physical effort for braking is required when the engine is switched off - risk of accident!
- Depress the clutch pedal when stopping or braking a vehicle with a petrol engine and manual transmission in the low rev range. If you fail to do so, the functionality of the brake booster can be impaired - risk of accident!
- If a front spoiler, full wheel trim, etc. is mounted retrospectively, it must be ensured that the air supply to the front wheel brakes is not reduced. Otherwise, the functionality of the brake system could be impaired - risk of accident!
- Please note that the handbrake must be fully released. A handbrake which is only partially released can result in the rear brakes overheating, which can have a negative effect on the operation of the brake system - risk of accident!
- Never leave children unattended in the vehicle. The children might, for example, release the handbrake or take the vehicle out of gear. The vehicle might then move off - risk of accident!
- A lack of fuel can cause irregular engine running or cause the engine to shut down. The brake assist systems would then be without function - risk of accident!
- Adjust the speed and driving style to the current visibility, weather, road and traffic conditions. The increased safety offered by the brake assist systems must not tempt you to take greater risks than otherwise - risk of an accident!
- The normal braking system is still fully functional if there is an ABS fault. Visit a ŠKODA specialist garage immediately and adjust your style of driving according to the damage to the ABS as you will not know how great the damage is and the limitation it is placing on the braking efficiency.

CAUTION

- Observe the recommendations on the new brake pads » [page 139](#).
- Never let the brakes slip with light pressure on the pedal if braking is not necessary. This causes the brakes to overheat and can also result in a longer braking distance and excessive wear.
- All four wheels must be fitted with the same tyres approved by the manufacturer to ensure the brake assist systems operate correctly.

Note

- If the brakes are applied in full and the control unit for the braking system considers the situation to be dangerous for the following traffic, the brake light flashes automatically. After the speed was reduced below around 10 km/h or the vehicle was stopped, the brake light stops flashing and the hazard warning light system switches on. The hazard warning light system is switched off automatically after accelerating or driving off again.
- Before negotiating a steep downhill section, reduce the speed, shift down into the next lower gear (manual gearbox) or select a lower drive position (automatic gearbox). As a result, the braking effect of the engine will be used, reducing the load on the brakes. Any additional braking should be completed intermittently, not continuously.
- Changes to the vehicle (e.g. to the engine, brakes, chassis or another combination of tyres and wheels) can influence the functionality of the brake assist systems » [page 177](#), *Accessories, changes and replacement of parts*.
- If a fault occurs in the ABS system, the ESC, ASR and EDL also do not work. A warning light  » [page 22](#) comes on if a fault occurs in the ABS system.

Information for braking



First read and observe the introductory information and safety warnings  on [page 93](#).

Wear-and-tear

The wear of the brake pads is dependent on the operating conditions and driving style. The brake pads wear more quickly if a lot of journeys are completed in towns and over short distances or if a very sporty style of driving is adopted. If operated under **severe conditions**, the thickness of the brake pads must be checked by a ŠKODA specialist garage before the next service appointment.

Wet roads or road salt

The performance of the brakes can be delayed as the brake discs and brake pads may be moist or have a coating of ice or layer of salt on them in winter. The brakes are cleaned and dried by applying the brakes several times.

Corrosion

Corrosion on the brake discs and dirt on the brake pads occur if the vehicle has been parked for a long period and if you do not make much use of the braking system. If the brake system is not used much or if there is corrosion on the surface, we recommend cleaning the brake discs by firmly applying the brakes from a fairly high speed.

Faults in the brake surface

If it is found that the braking distance has suddenly become longer and that the brake pedal can be depressed further, the brake system may be faulty. Visit a SKODA specialist garage immediately and adjust your style of driving appropriately as you will not know how great the damage is.

Low brake fluid level

An insufficient level of brake fluid may result in problems in the brake system. The level of the brake fluid is monitored electronically » [page 19, Brake system](#) .

Brake booster

The brake booster increases the pressure generated with the brake pedal. The brake booster only operates when the engine is running.

Handbrake

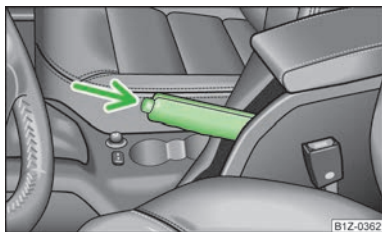



Fig. 95
Centre console: Handbrake

 **First read and observe the introductory information and safety warnings  on page 93.**

Apply

➤ Pull the handbrake lever firmly upwards.

Loosening

- Pull the handbrake lever up slightly and **at the same time** push in the locking button » [Fig. 95](#).
- Move the lever right down while pressing the lock button.

The handbrake warning light  lights up when the handbrake is applied, provided the ignition is on.

A warning signal sounds if the vehicle is inadvertently driven off with the handbrake applied.

The following is displayed in the information display:

Release parking brake!

The handbrake warning is activated if the vehicle is driven at a speed of more than 6 km/h for more than 3 seconds.

Stabilisation Control (ESC)



Fig. 96
ESC system: TCS button

 **First read and observe the introductory information and safety warnings  on page 93.**

The ESC is automatically activated after starting the engine. The ESC helps to maintain control of the vehicle in situations where it is being operated at its dynamic limits, such as a sudden change to the direction of travel. The risk of skidding is reduced and your car thus offers greater driving stability depending on the conditions of the road surface.

The direction which the driver wishes to take is determined based on the steering angle and the speed of the vehicle and is constantly compared with the actual behaviour of the vehicle. In the event of deviations, such as if the car starts to skid, the ESC automatically brakes the appropriate wheel.

The ESC cannot be switched off, the button  » [Fig. 96](#) only deactivates the TCS system and the warning light  in the instrument cluster lights up.

During an intervention of the system, the warning light  flashes in the instrument cluster.

In the event of an ESC fault, the ESC warning light illuminates in the instrument cluster  » [page 22](#).

The following systems are integrated into the **electronic stabilisation control (ESC)**:

- Antilock brake system (ABS),
- Traction control (TCS),

- Electronic Differential Lock (EDL and XDS);
- Active driver-steering recommendation (DSR),
- Brake assist,
- Uphill start assist.

Active driver-steering recommendation (DSR)

This function indicates to the driver in critical situations a steering recommendation in order to stabilise the vehicle. The active driver-steering recommendation is activated, for example, on the right and left vehicle side when braking sharply on different road surfaces.

Hydraulic brake assist

The brake assist system is activated by the very quick operation of the brake pedal (e.g. in the event of danger). It increases the braking effect and helps to shorten the braking distance. To achieve the shortest possible braking distance, the brake pedal must be applied firmly and held in this position until the vehicle has come to a complete standstill.

The ABS is activated faster and more effectively with the intervention of the brake assist system.

The brake assist function is automatically switched off when the brake pedal is released.

Uphill start assist

The uphill start assist makes it easier to start off on steep hills. The system holds the brake pressure produced by the activation of the brake pedal for approx. 2 seconds after the brake pedal is released. The driver can therefore move his foot from the brake pedal to the accelerator pedal and start off on the slope, without having to actuate the handbrake. The brake pressure drops gradually the more you operate the accelerator pedal. If the vehicle does not start off within 2 seconds, it starts to roll back.

The uphill start assist is active as of a 5 % slope, if the driver door is closed. It is always active on slopes when in forward or reverse start off. When driving downhill, it is inactive.

Antilock brake system (ABS)



First read and observe the introductory information and safety warnings **I** on page 93.

ABS prevents the wheels locking when braking. Thus helping the driver to maintain control of the vehicle.

The intervention of the ABS is noticeable from the **pulsating movements of the brake pedal** which is accompanied by noises.

Do not reduce the pressure on the brake pedal during the intervention of the ABS. The ABS deactivates if the brake pedal is released. Never interrupt the application of the brakes during the intervention of the ABS!

Traction control system (TCS)



Fig. 97
TCS button



First read and observe the introductory information and safety warnings **I** on page 93.

The TCS is automatically activated after starting the engine. If the wheels are slipping, the TCS adapts the engine speed to the conditions of the road surface. The TCS makes it much easier to start off, accelerate and climb steep hills even if the conditions of the road surface are unfavourable.



The TCS should normally always be switched on. It may be advisable to switch off the system in certain exceptional circumstances, such as:

- when driving with snow chains;
- when driving in deep snow or on a very loose surface;
- when it is necessary to "rock a vehicle free" when it has got stuck.

Ensure the TCS is switched on again afterwards.

During an intervention of the system, the TCS warning light  flashes in the instrument cluster.

The TCS warning light  [» page 21](#) lights up in the instrument cluster when there is a fault on the TCS.

If necessary, the TCS can be switched off and on again by pressing the button  » Fig. 97, or on vehicles with ESP, by pressing the button  » Fig. 96 on page 95. The TCS warning light  lights up in the instrument cluster when the TCS is switched off.

Electronic Differential Lock (EDS and XDS)

 **First read and observe the introductory information and safety warnings  on page 93.**

If one of the wheels starts to spin, the EDL system brakes the spinning wheel and transfers the driving force to the other wheels. This ensures the stability of the vehicle and a quick journey.

The EDL switches off automatically if unusually severe stresses exist in order to avoid excessive heat generation in the disc brake on the wheel which is being braked. The vehicle can continue to be driven and has the same characteristics as a vehicle not fitted with EDL. The EDL switches on again automatically as soon as the brake has cooled down.

XDL (only for Octavia RS)

XDL is an extension to the electronic differential lock. XDL does not respond to traction, but to the relief of the inner front wheel during fast cornering. The active brake intervention on the brake of the inner wheel prevents it from spinning. Thus, the traction is improved and the vehicle continues to follow the desired track.

Shifting (manual gearbox)



Fig. 98
The shift pattern: 5-speed or 6-speed manual gearbox

Always depress the clutch pedal fully when changing gear, to prevent excessive wear of the clutch.

The gearshift indicator must be observed when changing gear » page 11, *Recommended gear*.

Only engage reverse gear when the vehicle is stationary. Depress the clutch pedal and hold it fully depressed. Wait a moment before reverse gear is engaged to avoid any shift noises.

The reversing lights will come on once reverse gear is engaged, provided the ignition is on.

WARNING

Never engage reverse gear when driving - risk of accident!

Note

If not in the process of changing gear, do not leave your hand on the gearshift lever while driving. The pressure from the hand can cause the gearshift mechanism to wear excessively.

pedals

The operation of the pedals must not be hindered under any circumstances!

In the driver's footwell, only a footmat, which is attached to the two corresponding attachment points, may be used.

Only use footmats from the range of ŠKODA Original Accessories, which are fitted to two attachment points.

WARNING

No objects are allowed in the driver's footwell - risk of obstruction or limitation in operating the pedal!

Parking aid

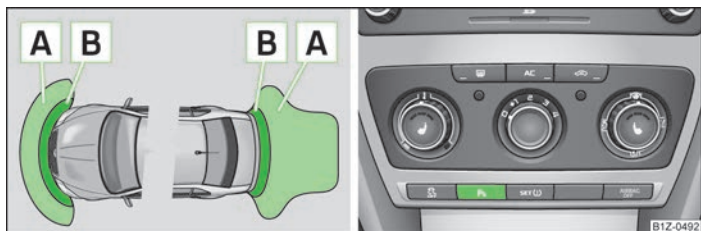

Fig. 99 Parking aid: Range of the sensors/activating the parking aid

The parking aid determines the distance between the front or rear bumper and an obstacle with the aid of ultrasound sensors. The sensors are integrated in the front/rear bumper.

The signal tones for the front parking aid sound higher than for the rear parking aid. The tones of the parking aid can be adapted in the menu of the Information display » [page 16](#).

Range of sensors

The distance warning begins at a distance of about 160 cm from the obstacle at the rear of the vehicle and about 120 cm from the obstacle in front of the vehicle **A** » Fig. 99. The interval between the warning signals becomes shorter as the clearance is reduced.

A continuous tone sounds from a distance of approx. 30 cm **B** » Fig. 99 - danger area. **From this moment on do not continue driving!**

On vehicles with a factory-fitted radio or navigation system, the distance to the obstacle is simultaneously graphically illustrated on the display, refer to the operating instructions for the radio or navigation system.

On vehicles with a factory-fitted towing device, the border of the danger area starts (continuous tone) 5 cm further away from the vehicle. The length of the vehicle can be increased with an installed detachable towing device.

On vehicles with a factory-fitted towing device, the rear sensors are deactivated when towing a trailer.

Activating/deactivating the rear parking aid

The parking aid is activated automatically when **reverse gear** is engaged and the ignition is turned on. This is confirmed by a brief audible signal.

The parking aid is deactivated by removing the reverse gear.

Activating/deactivating the front and rear parking aid

The parking aid is activated when the ignition is turned on and **reverse gear** is engaged and or by pressing the button **P** » Fig. 99 - the symbol **P** lights up in the button. This is confirmed by a brief audible signal.

The parking aid is deactivated by pressing the button **P** or at a speed of more than 10 km/h (the symbol **P** in the button is no longer illuminated).

! WARNING

- The parking aid is not a substitute for the driver paying proper attention and it is always the driver's responsibility to take care when reversing the vehicle or carrying out similar manoeuvres. Pay particular attention to small children and animals as they are not recognised by the parking aid sensors.
- Before reversing or parking, check that there is no small obstacle, such as a rock, thin post, trailer drawbar etc., in front of or behind the vehicle. Such obstacles may not be recognised by the parking aid sensors.
- Under certain circumstances, surfaces of certain objects and types of clothing cannot reflect the signals from the parking aid. Thus, these objects or people who wear such clothing are not recognised by the parking aid sensors.
- External sound sources can have a detrimental effect on the parking aid. Under unfavourable conditions, objects or people may not be recognised.

i Note

- If a warning signal sounds for about 3 seconds after activating the system and there is no obstacle close to your car, this indicates a system fault. The fault is confirmed additionally when the symbol **P** flashes in the button **P**. Have the fault rectified by a ŠKODA specialist garage.
- The sensors must be kept clean (free of ice, etc.) to enable the parking aid to operate properly.
- If the parking aid is activated and the selector lever of the automatic gearbox is in the position **P**, the warning signal is interrupted (the vehicle cannot move).

Cruise control system (CCS)

Introduction

This chapter contains information on the following subjects:

Storing a speed	99
Changing a stored speed	99
Switching off the cruise control system temporarily	100
Switching off the cruise control system completely	100

The cruise control system (CCS) maintains a constant speed, more than 30 km/h (20 mph), once it has been set, without you having to depress the accelerator pedal. This is only possible within the range which is permitted by the power output and braking power of the engine.

The warning light  illuminates in the instrument cluster when the cruise control system is activated.

! WARNING

- For safety reasons, the cruise control system must not be used in dense traffic or on unfavourable road surfaces (such as icy roads, slippery roads, loose gravel) - risk of accident!
- The saved speed may only be resumed if it is not too high for the current traffic conditions.
- Always switch off the cruise control system after use to prevent unintentional use of the system.

! CAUTION

- Always depress the clutch pedal if switching to the neutral position (vehicle with a manual gearbox) when the cruise control system is switched on! Otherwise the engine can rev up unintentionally.
- The cruise control system is not able to maintain a constant speed when driving in areas with steeper gradients. The weight of the vehicle increases the speed at which it travels. Therefore, shift to a lower gear in good time or slow the vehicle down by applying the foot brake.

i Note

It is not possible on vehicles fitted with an automatic gearbox to switch on the cruise control system if the selector lever is in the position **P**, **N** or **R**.

Storing a speed

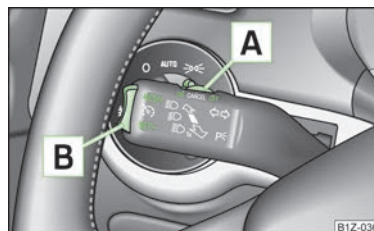



Fig. 100
Turn signal and main beam lever:
Rocker switch and switch of the
cruise control system

 First read and observe the introductory information and safety warnings  on page 99.

Storing a speed

- Turn the switch **A** » Fig. 100 into the **ON** position.
- After the desired speed has been reached, press the rocker button **B** into the **SET** position.

After you have released the rocker button **B** out of the position **SET**, the speed you have just stored is maintained at a constant speed without having to depress the accelerator.

Changing a stored speed

 First read and observe the introductory information and safety warnings  on page 99.

Increasing the speed with the accelerator

- Depress the accelerator to increase the speed.
- Release the accelerator to reduce the speed back down to the preset speed.

However, if the saved speed is exceeded by more than 10 km/h for a period of more than 5 minutes by depressing the accelerator, the stored speed is deleted from the memory. You have to re-store the desired speed.

Increasing the speed with the rocker button **[B]**

- Press the rocker button **[B]** » Fig. 100 on page 99 into the **RES** position.
- The speed will increase continuously, if the rocker button is pressed and held in the **RES** position. Release the rocker button once the desired speed is reached. The set speed is then stored in the memory.

Decreasing the speed

- The stored speed can be **reduced** by pressing the rocker button **[B]** » Fig. 100 on page 99 into the position **SET**.
- The speed will decrease continuously, if the rocker button is pressed and held in the **SET** position. Release the rocker button once the desired speed is reached. The set speed is then stored in the memory.
- If the rocker button is released at a speed of less than 30 km/h, the speed is not stored and the memory is erased. The speed must then be stored again by pressing the rocker button **[B]** in the position **SET** after increasing the speed of the vehicle to more than 30 km/h.

The speed can also be reduced by depressing the brake pedal, which temporarily deactivates the system.

Switching off the cruise control system temporarily



First read and observe the introductory information and safety warnings **[I]** on page 99.

The cruise control system is **temporarily switched off** by pressing the switch **[A]** » Fig. 100 on page 99 into the spring-tensioned position **CANCEL** or by depressing the brake or clutch pedal.

The set speed remains stored in the memory.

Briefly press the rocker button **[B]** into the position **RES** to **resume** the stored speed after the clutch or brake pedal is released.

Switching off the cruise control system completely



First read and observe the introductory information and safety warnings **[I]** on page 99.

- Turn the switch **[A]** » Fig. 100 on page 99 into the **OFF** position.

START/STOP



Fig. 101
Button for the START-STOP system

The START-STOP system helps you to save fuel while at the same time reducing harmful exhaust emissions and CO₂ emissions.

The function is automatically activated each time the ignition is switched on.

In the start-stop mode, the engine automatically switches to the vehicle's idle phase, e.g. when stopped at traffic lights.

Information regarding the current state of the START-STOP system is indicated in the display of the instrument cluster.

Automatic engine shut down (stop phase)

- Stop the vehicle (where necessary, apply the handbrake).
- Take the vehicle out of gear.
- Release the clutch pedal.

Automatic renewed engine restart (start phase).

- Depress the clutch pedal.

Switching the START-STOP system on and off

The START/STOP system can be switched on/off by pressing the button **[A]** » Fig. 101.

When start-stop mode is deactivated, the warning light in the button lights up.

If the vehicle is in the stop phase when manually switching off the system, the engine starts immediately.

The START-STOP system is very complex. Some of the procedures are hard to check without servicing. The general conditions for the proper functioning of the START-STOP system are listed in the following overview.

Conditions for the automatic engine shut down (stop phase):

- The gearshift lever is in Neutral.
- The clutch pedal is not depressed.
- The driver has fastened the seat belt.
- The driver's door is closed.
- The bonnet is closed.
- The vehicle is at a standstill.
- The factory-fitted towing device is not electrically connected to a trailer.
- The engine is at operating temperature.
- The charge state of the vehicle battery is sufficient.
- The stationary vehicle is not on a steep slope or a steep downhill section.
- The engine speed is less than 1 200 rpm.
- The temperature inside the vehicle battery is not too low or too high.
- There is sufficient pressure in the braking system.
- The difference between the outdoor- and the set temperature in the interior is not too great.
- The vehicle speed since the last time the engine was switched off was greater than 3 km/h.
- No cleaning of the diesel particle filter takes place » [page 23](#).
- The front wheels are not turned excessively (the steering angle is less than 3/4 of a steering wheel revolution).

Conditions for an automatic restart (start phase):

- The clutch pedal is depressed.
- The max./min. temperature is set.
- The defrost function for the windshield is switched on.
- A high blower stage has been selected.
- The START STOP button is pressed.

Conditions for an automatic restart without driver intervention:

- The vehicle moves at a speed of more than 3 km/h.
- The difference between the outdoor- and the set temperature in the interior is too great.
- The charge state of the vehicle battery is not sufficient.
- There is insufficient pressure in the braking system.

If the driver's seat belt is removed for more than 30 seconds or the driver's door is opened during stop mode, the engine must be started manually with the key. The following messages in the instrument cluster display must be observed.

Messages in the instrument cluster display (valid for vehicles without Information display)

ERROR START STOP	Error in the START-STOP system
START STOP NOT POSSIBLE	Automatic engine shut down is not possible.
START STOP ACTIVE	Automatic engine shut down (stop phase)
SWITCH OFF IGNITION	Switch off the ignition.
START MANUALLY	Start the engine manually.

WARNING

- The brake servo unit and power steering only operate if the engine is running.
- Never let the vehicle roll with the engine switched off.

CAUTION

Deactivate the START-STOP system before driving through water on the street » [page 144](#).

Note

- Changes to the outdoor temperature can have an effect on the internal temperature of the vehicle battery even after several hours. If the vehicle remains outdoors for a long time in minus temperatures or in direct sunlight, it can take several hours until the internal temperature of the vehicle battery reaches a suitable temperature for proper operation of the START STOP system.
- If the Climatronic is running in automatic mode, under certain conditions, the engine may not switch off automatically. ■

Automatic gearbox

Automatic gearbox

Introduction

This chapter contains information on the following subjects:

Introductory information	102
Starting-off and driving	103
Selector lever positions	103
Manual shifting of gears (Tiptronic)	104
Selector lever lock	105
Kickdown function	105
Dynamic shift programme	105
Emergency programme	106
Selector lever-emergency unlocking	106



WARNING

- Do not depress the accelerator if changing the position of the selector lever when the vehicle is stationary and the engine is running - risk of accident!
- Never move the selector lever into position **R** or **P** when driving - risk of an accident!
- When the engine is running and the vehicle is stationary, it is necessary to hold the car with the brake pedal in all the positions of the selector lever (except **P** and **N**) since the power transmission is never completely interrupted, also not when the engine is idling - the vehicle creeps.
- The selector lever must be placed into position **P** and the handbrake firmly applied before the bonnet can be opened and work on the running engine can be completed - risk of accident! The safety guidelines must always be observed » [page 158, Engine compartment](#).



WARNING (Continued)

- If stopping on a hill (downhill gradient), never try to maintain the vehicle stationary with the gear engaged by means of the "accelerator pedal", i.e. by letting the clutch slip. This can lead to overheating of the clutch. If there is a risk of overheating of the clutch due to overload, the clutch is opened automatically and the vehicle rolls backward - risk of accident!
- If you have to stop on a slope, depress and hold the brake pedal to prevent the vehicle from rolling back.
- On a smooth or slippery road surface using the kickdown function can cause the driven wheels to spin - risk of skidding!

CAUTION

- The double clutch on the automatic gearbox DSG is equipped with an overload protection. If the uphill function is used when the vehicle is stationary or driving slowly uphill, the thermal stress on the clutches is increased.
- If the clutch system overheats, the symbol  is shown in the information display along with the message **Gearbox overheated. Stop! Owner's man.!** appears. An audible signal sounds as a warning signal. Stop the vehicle, switch off the engine, and wait until the symbol  disappears - risk of gearbox damage! You can continue your journey as soon as the symbol disappears.

Introductory information

 **First read and observe the introductory information and safety warnings  on page 102.**

Shifting up and down through the gears is performed automatically. The gearbox can also be switched to **Tiptronic** mode. This mode makes it possible for you to also shift gears manually » [page 104](#).

The engine can only be **started** when the selector lever is in position **P** or **N**. If the selector lever is not in the **P** or **N** positions when locking the steering, switching the ignition on or off or when leaving the engine on, the following message will appear in the Information display **Move selector lever to position P/N!** or, in the instrument cluster display: → **P/N**.

At temperatures below -10 °C the engine can only be started in the selector lever position **P**¹⁾.

¹⁾ Applies to DSG.

When parking on a level road surface, it suffices to engage selector lever position **P**. When parking on a slope, the handbrake should be applied firmly before the park position is selected. This ensures that there is no excessive pressure on the lock mechanism and that it is subsequently easier to move the selector lever out of position **P**.

If the selector lever position **N** is accidentally selected while driving, it is first necessary to release pressure on the accelerator pedal and wait for the idling speed of the engine to be reached before the selector lever can be engaged in the drive position.

Starting-off and driving

 First read and observe the introductory information and safety warnings  on page 102.

Starting off

- Firmly depress and hold the brake pedal.
- Press the Shiftlock button (button in the selector lever handle), move the selector lever into the desired position » page 103 and then release the Shiftlock button.
- Wait a moment until the gearbox has shifted (a slight engagement nudge can be felt)¹⁾.
- Release the brake pedal and accelerate.

Stop

- The selector lever position **N** does not have to be selected when stopping for a short time, such as at a cross roads. It is sufficient to hold the vehicle stationary using the foot brake. The engine can, however, be allowed just to idle.

Parking

- Depress the brake pedal.
- Firmly apply the handbrake.
- Press and Shiftlock button in the selector lever, move the selector lever to **P** and then release the Shiftlock button.

Selector lever positions

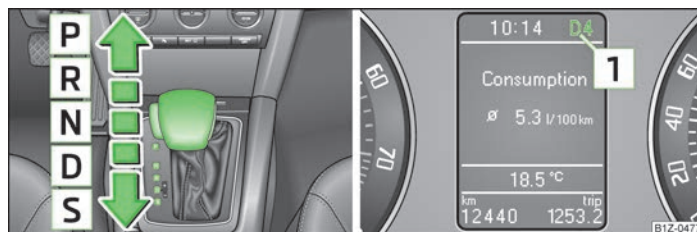



Fig. 102 Selector lever/information display: Selector lever positions

 First read and observe the introductory information and safety warnings  on page 102.

The current selector lever position is indicated in the information display of the instrument cluster  » Fig. 102.

P - Parklock

The driven wheels are locked mechanically in this position.

The Parklock must only be engaged when the vehicle is stationary.

If you wish to move the selector lever into/out of this position, the Shiftlock button in the selector lever handle and the brake pedal must be actuated at the same time.

If the battery is used, the selector lever cannot be moved out of the position **P**.

R - Reverse gear

Reverse gear must only be engaged when the vehicle is stationary and the engine is idling.

The brake pedal must be depressed and at the same time the Shiftlock must be pressed, if you wish to obtain the selector lever positions **R**, **P** or **N**.

When the ignition is switched on and the selector lever is in position **R**, the reverse lights will come on.

¹⁾ Applies to AG.

N - Neutral

The transmission is in Neutral in this position.

The brake pedal must be depressed to move the selector lever out of the position **N** (if the lever is in this position for longer than 2 seconds) into the position **D** or **R** when the vehicle is travelling at less than 5 km/h or the vehicle is stationary and the ignition is switched on.

D - Position for driving forward (normal programme)

When the selector lever is in this position, the forward gears are automatically shifted up and down in line with the engine load, vehicle speed and dynamic shift programme.

The brake pedal must be depressed to move the selector lever into position **D** from **N** when the vehicle is travelling at less than 5 km/h or is stationary.

Under certain circumstances (e.g. when driving in mountainous regions or when towing a trailer) it may be beneficial to select the manual shift programme » page 104 for a short time in order to adapt the gearbox ratios manually to the driving situations.

S - Position for driving forward (sports programme)

Shifting up later into a higher gear makes it possible to fully exploit the power potential of the engine. The gearbox also then shifts down at higher engine speeds as in the position **D**.

The Shiftlock on the selector lever grip must be pressed when moving the selector lever out of the position **D** into the position **S**.

Manual shifting of gears (Tiptronic)

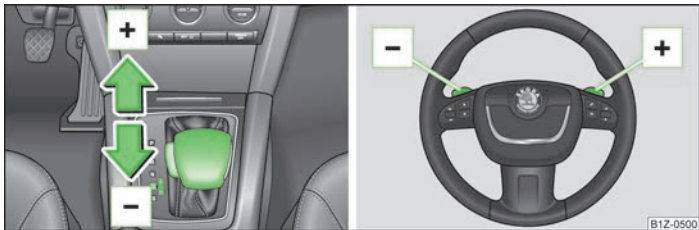

Fig. 103 Selector lever and multifunction steering wheel



First read and observe the introductory information and safety warnings **I** on page 102.

Tiptronic mode makes it possible to manually shift gears with the selector lever or multifunction steering wheel.

Switching to manual shifting

➤ Push the selector lever to the right out of position **D**. The selector lever position you have engaged is indicated in the information display of the instrument cluster together with the engaged gear **1** » Fig. 102 on page 103 on the right.

Shifting up gears

➤ Press the selector lever forwards **+** » Fig. 103.

➤ Pull the right rocker switch **+** towards the multifunction steering wheel.

Shifting down gears

➤ Press the selector lever backwards **-** » Fig. 103.

➤ Pull the left rocker switch **-** towards the multifunction steering wheel.

Temporarily switching to manual shifting

➤ If the selector lever is in position **D** or **S**, pull the left rocker switch **-** or the right rocker switch **+** towards the multifunction steering wheel.

➤ Manual shifting switches off if the rocker switches **-** or **+** are not actuated for some time. You can also switch off the temporary switch-over to manual shifting by pressing the right rocker switch **+** for more than 1 second.

It is possible to switch to manual shifting when the car is stationary and when driving.

When accelerating, the gearbox automatically shifts up into the higher gear just before the maximum permissible engine speed is reached.

If a lower gear is selected, the gearbox does not shift down until there is no risk of the engine overrevving.

If you operate the kickdown function, the gearbox shifts into a lower gear in line with the vehicle speed and engine speed.

i Note



The kickdown function is also available when manually shifting gears.

Selector lever lock



First read and observe the introductory information and safety warnings  on page 102.

Automatic selector lever lock

With the ignition on, the selector lever is locked when it is in the positions **P** and **N**. The brake pedal must be depressed to move the selector lever out of this position. The warning light  » page 25, *Selector lever lock*  illuminates in the instrument cluster as a reminder for the driver when the selector lever is in the positions **P** and **N**.

The selector lever is not locked when quickly moving across the position **N** (e.g. from **R** to **D**). This, for example, helps to rock out a vehicle that is stuck. The selector lever lock will click into place if the lever is in the **N** position for more than 2 seconds without the brake pedal being pressed.

The selector lever lock is only active if the vehicle is stationary or moving at speed of less than 5 km/hour. The lock is switched off automatically into position **N** when the car is travelling at a higher speed.

Shiftlock button

The Shiftlock button in the handle of selector lever prevents certain selector lever positions being engaged inadvertently. The selector lever lock is cancelled when the Shiftlock button is pressed.

Ignition key withdrawal lock

After the ignition is switched off, the ignition key can only be withdrawn if the selector lever is in the position **P**. If the ignition key is withdrawn, the selector lever is blocked in position **P**.

Kickdown function



First read and observe the introductory information and safety warnings  on page 102.

The kickdown function provides you with maximum acceleration power.

When the accelerator pedal is fully depressed, the kickdown function is activated in the desired driving program. This function has precedence over the driving programme and serves for maximum acceleration of the vehicle when exploiting the maximum power potential of the engine without taking into account the current selector lever position (**D**, **S** or **Tiptronic**). The gearbox shifts down to one or sev-

eral gears in line with the driving state and the vehicle accelerates. The gearbox does not shift up into the highest gear until the engine has reached its maximum revolutions for this gear range.

Dynamic shift programme



First read and observe the introductory information and safety warnings  on page 102.

The automatic gearbox of your vehicle is controlled electronically. Shifting up and down through the gears is performed automatically on the basis of pre-defined driving programmes.

Adopting a **moderate style of driving** will cause the gearbox to select the most economical driving programme. Shifting up into a higher gear as soon as possible and shifting down as late as possible will have a favourable effect on your fuel consumption.

When adopting a **sporty style of driving** with rapid movements of the accelerator pedal combined with sharp acceleration, frequent changes in speed and exploiting the top speed of the car, the gearbox will adjust to this style of driving once the accelerator pedal (kickdown function) is depressed and will shift down earlier, frequently by several gears in comparison to a moderate style of driving.

Selecting the most appropriate driving programme for the particular style of driving is a continuous process. Irrespective of this it is, however, possible to switch or shift down into a dynamic shift programme by depressing the accelerator rapidly. The gearbox shifts down into a lower gear in accordance with the speed, therefore enabling rapid acceleration (e.g. when overtaking) without the accelerator pedal having to be depressed into the kickdown range. The original programme will be reactivated to match your particular style of driving once the gearbox has shifted up again.

When driving in hilly regions, the gears are selected to match uphill and downhill sections. This avoids the gearbox frequently shifting up and down when negotiating an uphill stretch. When driving downhill, it is possible to shift down into the Tiptronic position, in order to exploit the engine brake torque.

Emergency programme



First read and observe the introductory information and safety warnings **i** on page 102.

An emergency programme exists in the event of a fault in the system.

The gearbox operates in a corresponding emergency programme if there are functional faults in the gearbox electronics. All of the display elements illuminate or go out.

A functional fault can have the following effect:

- The gearbox only shifts into certain gears;
- The reverse gear **R** cannot be used,
- The manual shift programme is switched off in emergency mode.



Note

If the gearbox has switched to emergency mode, drive to a ŠKODA specialist garage to have the fault rectified.

Selector lever-emergency unlocking

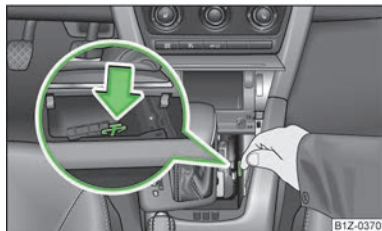

Fig. 104
Selector lever-emergency unlocking



First read and observe the introductory information and safety warnings **i** on page 102.

In case of interruption of the power supply (e.g. flat vehicle battery, defective fuse) or defect of the selector lever lock, the selector lever can no longer be shifted from the position **P** in the normal way and the vehicle can no longer be moved. The selector lever must be unlocked in case of emergency.

- Firmly apply the handbrake.
- Open the storage compartment in front centre console or the front ashtray.

- Carefully pull up the front left and right cover.
- Pull up rear cover.
- Use a finger to press the yellow plastic part in the direction of the arrow » Fig. 104.
- Simultaneously press the Shiftlock button in the handle of the selector lever and shift the lever into the position **N** (if the selector lever is shifted back into the position **P**, it is blocked again).

Communication

Mobile phones and two-way radio systems

ŠKODA permits the operation of mobile phones and two-way radio systems with a professionally installed external aerial and a maximum transmission power of up to 10 watts.

Please refer to a ŠKODA Service Partner for information about the possibilities of installing and operating mobile phones and two-way radio systems that have a transmission power of more than 10 W.

Operating mobile phones or two-way radio systems may interfere with the functionality of the electronic systems in your vehicle.

The reasons for this are as follows:

- no external aerial;
- external aerial incorrectly installed;
- transmission power greater than 10 watts.

WARNING

- Concentrate fully at all times on your driving! As the driver you are fully responsible for the operation of your vehicle. Use the telephone system only to such an extent that you are in full control of your vehicle at any time.
- The national regulations for using a mobile phone in a vehicle must be observed.

WARNING (Continued)

- If a mobile phone or a two-way radio system is operated in a vehicle without an external aerial or an external aerial which has been installed incorrectly, this can increase the strength of the electromagnetic field inside the vehicle.
- Two-way radio systems, mobile phones or mounts must not be installed on airbag covers or within the immediate deployment range of the airbags.
- Never leave a mobile phone on a seat, on the dash panel or in another area, from which it can be thrown during a sudden braking manoeuvre, an accident or a collision - risk of injury.
- In the event of air transport, the Bluetooth® function for the hands-free system must be switched off by a specialist garage.

Note

- We recommend that the installation of mobile phones and two-way radio systems in a vehicle be carried out by a ŠKODA Service Partner.
- Not all mobile phones that enable Bluetooth® communication are compatible with the universal telephone preinstallation GSM II or GSM III. Ask a ŠKODA Service Partner to find out if your phone is compatible with the universal telephone preinstallation GSM II or GSM III.
- The range of the Bluetooth® connection to the hands-free system is restricted to the vehicle interior. The range is dependent on local factors, e.g. obstacles between the devices and mutual interferences with other devices. If your mobile phone is in a jacket pocket, for example, this can lead to difficulties when establishing a connection with the hands-free-system or transferring data.

Operating the phone on the multifunction steering wheel

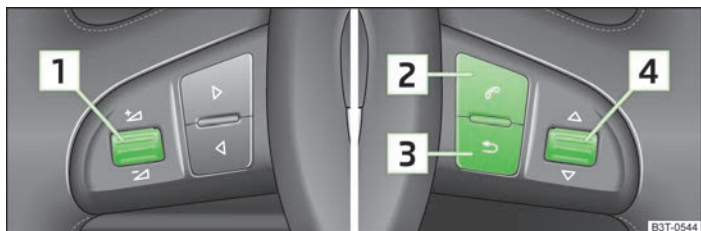

Fig. 105 Multifunction steering wheel: Control buttons for the telephone

The driver can set the basic functions of the telephone by simply operating the buttons located on the steering wheel so that he can concentrate on the traffic situation without being distracted as little as possible by operating the telephone » Fig. 105.

This applies only if your vehicle has been equipped with the universal telephone preinstallation (hands-free system) at the factory.

The buttons operate the functions for the operating mode of the current telephone.









If the side lights are switched on, the buttons on the multifunction steering wheel are illuminated.

Button	Action	Operation
1	Press briefly	Switch on/off the voice control (Button PTT - Push to talk) Cancellation of the played message
1	Turn upwards	Increase volume
1	Turn downwards	Decrease volume
2	Press briefly	Accept call, end call, entry in the main menu of the telephone, list of the dialed numbers, call the dialed contact
2	Press button for a long period of time	Reject call, private call ^{a)} Reject call, list of the last calls, access to the main menu of the phone, list of dialled numbers ^{b)}
3	Press briefly	Reach one level higher in the menu (according to the current position in the menu)
3	Press button for a long period of time	Leave the phone menu
4	Press briefly	Confirm menu selection
4	Press button for a long period of time	To the next initial letter in the telephone book
4	Turn upwards	The last chosen menu selection, name
4	Turn downwards	The next menu selection, name
4	Quickly turn upwards	To the previous initial letter in the telephone book
4	Quickly turn downwards	To the next initial letter in the telephone book

^{a)} Applies to GSM II.

^{b)} Applies to GSM III.

Symbols in the information display

Symbol	Importance	Valid for
	Charge status of the phone battery ^{a)}	GSM II, GSM III
	Signal strength ^{a)}	GSM II, GSM III
	a phone is connected to the hands-free system.	GSM II, GSM III when connected via the HFP profile
	The hands-free system is visible to other devices.	GSM II, GSM III when connected via the HFP profile
	a phone is connected to the hands-free system.	GSM III when connected via the rSAP profile
	The hands-free system is visible to other devices.	GSM III when connected via the rSAP profile
	A multimedia unit is connected to the hands-free system.	GSM II, GSM III
	A UMTS network is available.	GSM III
	Internet connection via the hands-free system	GSM III when connected via the rSAP profile

^{a)} This function is only supported by some mobile phones.

Phone Phonebook

A phone phonebook is part of the hands-free system. This phone phonebook can be used depending on the type of mobile phone.

After the first connection of the telephone, the system begins to load the phone book from the phone and the SIM card into the memory of the control unit.

Each time the telephone has established a new connection with the hands-free system, an update of the relevant phone book is performed. The updating can take a few minutes. During this time the phone book, which was stored after the last update was completed, is available. Newly stored telephone numbers are only shown after the updating has ended.

The update is interrupted if a telephone event (e.g. incoming or outgoing call, voice control dialogue) occurs during the updating procedure. After the telephone event has ended, the updating starts anew.

GSM II

The internal phonebook provides 2 500 free memory locations. Each contact can contain up to 4 numbers.

On vehicles fitted with the Columbus navigation system, a maximum of 1 200 telephone contacts are shown on the display of this appliance.

If the number of contacts loaded exceeds 2 500, the phone book is not complete.

GSM III

The internal phonebook provides 2 000 free memory locations. Each contact can contain up to 5 numbers.

On vehicles fitted with the Columbus navigation system, a maximum of 1 000 telephone contacts are shown on the display of this appliance.

If the mobile phone's telephone book has more than 2 000 contacts, the following message will appear in the information display:

Phone book not fully loaded

Universal telephone preinstallation GSM II

Introductory information

The universal telephone preinstallation GSM II ("hands-free system") includes a convenience mode for the mobile phone via voice control, the multifunction steering wheel, the adapter, radio or the navigation system.

The universal telephone preinstallation GSM II comprises the following functions.

- Phone Phonebook » [page 109](#).
- Convenience operation of the telephone via the multifunction steering wheel » [page 108](#).

- › Managing telephone calls via the adapter » page 111.
- › Operation of the telephone via the information display » page 112.
- › Voice control of the telephone » page 116.
- › Music playback from the telephone or other multimedia units » page 118.

All communication between a mobile phone and your vehicle's hands-free system is established with the help of Bluetooth® technology. The adapter serves only for charging the telephone and for transmitting the signal to the vehicle's external aerial.

Note

The following guidelines must be observed » page 107, *Mobile phones and two-way radio systems*.

Connecting the mobile phone to the hands-free system

To connect a mobile phone with the hands-free system, the two devices must be paired. Detailed information on this is provided in the operating instructions for your mobile phone. The following steps must be carried out for the connection.

- › Activate Bluetooth® and the visibility of your mobile phone on your telephone.
- › Switch on the ignition.
- › Select the menu **Phone - New user** in the information display and wait until the control unit has completed the search.
- › Select your mobile phone from the menu of the units found.
- › Confirm the PIN¹⁾.
- › If the hands-free system announces (as standard **SKODA_BT**) on the display of the mobile phone, enter the PIN¹⁾ within 30 seconds and wait, until the connection is established²⁾.
- › After terminating the connection, confirm the creation of a new user profile in the information display.

If there is no free space available to create a new user profile, delete an existing user profile.

During the connecting procedure, no other mobile phone may be connected with the hands-free system.

¹⁾ Depending on the Bluetooth® version on the mobile phone, an automatically generated 6-digit PIN is either displayed or the PIN **1234** has to be entered manually.

²⁾ Some mobile phones have a menu, in which the authorisation for establishing a Bluetooth® connection is completed by inputting a code. If the authorisation input is required, it must always be performed when re-establishing the Bluetooth connection.

Up to four mobile phones can be paired with the hands-free system, whereby only one mobile phone can communicate with the hands-free system.

The visibility of the hands-free system is automatically switched off 3 minutes after the ignition is switched on and is also deactivated when the mobile phone has connected to the hands-free system.

Restoring the visibility of the hands-free system

If you have not managed to connect your mobile phone with the hands-free system within 3 minutes of switching on the ignition, the visibility of the hands-free system can be reestablished for 3 minutes in the following ways.

- › By turning the ignition off and on.
- › By turning voice control off and on.
- › Via the information display in the menu item **Bluetooth - Visibility**.

Creating a connection with an already paired mobile phone

After switching on the ignition, the connection is automatically established for the already paired mobile phone²⁾. Check on your mobile phone if the automatic connection has been established.

Disconnecting the connection

- › By withdrawing the ignition key.
- › By disconnecting the hands-free system in the mobile phone.
- › By disconnecting the user in the information display in the menu **Bluetooth - User**.

Solving connection problems

If the system announces **No paired phone found**, check the operating state of the mobile phone.

- › Is the mobile phone switched on?
- › Is the PIN code entered?
- › Is Bluetooth® active?
- › Is the visibility of the mobile phone active?
- › Has the mobile phone already been paired with the hands-free system? ▶

i Note

- If a suitable adapter is available for your mobile phone, only use your mobile phone in the adapter inserted in the telephone mount so that the radiation in the vehicle drops to a minimum.
- Placing the mobile phone in the adapter inserted in the telephone mount ensures optimum sending and receiving power.

Inserting the mobile phone and adapter

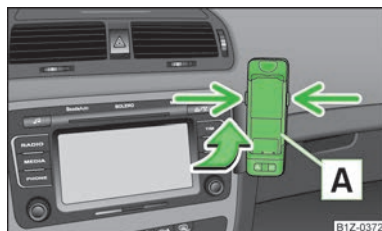

Fig. 106
Universal telephone preinstallation

Only one telephone mount is factory-fitted. An adapter for the mobile phone can be purchased from ŠKODA Original Accessories.

Inserting the adapter and mobile phone

- First of all push the adapter **A** in the direction of the arrow » Fig. 106 up to the stop into the mount. Then press the adapter slightly downwards, until it locks securely into position.
- Insert the mobile phone into the adapter **A** (as specified in the instructions from the manufacturer of the adapter).

Removing the adapter and mobile phone

- Simultaneously press the locks on the mount » Fig. 106 and remove the adapter with the mobile phone.

! CAUTION

Taking the mobile phone out of the adapter during the call can lead to interruption of the connection. When removing the mobile phone, the connection to the factory-fitted antenna is interrupted, which reduces the quality of the transmitting and receiving signal. The charging of the mobile phone battery is also interrupted.

Managing telephone calls with the help of the adapter



Fig. 107 Principle sketch: single-button adapter/two-button adapter

Function overview of the  » Fig. 107 (PTT - "push to talk") button on the adapter:

- Switch on/off voice control;
- Accept/end a call.

On some adapters include the button  » Fig. 107 **A** in addition to the button . After pressing this button for 2 seconds, the number 112 (Emergency call) is dialled.

i Note

On vehicles fitted with the Columbus navigation system, the buttons  and  do not work.

Operate the telephone via the information display

The following menu points can be selected in the menu **Phone**.

- **Phone book**
- **Dial number**¹⁾
- **Call register**
- **Voice mailbox**
- **Bluetooth**¹⁾
- **Settings**²⁾
- **Back**

Phone book

In the menu point **Phone book** is the list of the loaded contacts from the telephone memory and the SIM card of the mobile phone.

Dial number

Any telephone number can be entered in the menu point **Dial number**. The required numbers must be selected one after the other using adjustment wheel and confirmed by pressing the adjustment wheel. Numbers **0 - 9**, symbols **+**, *****, **#** and the functions **Cancel**, **Call**, **Delete** can be selected.

Call register

The following menu items can be selected in the menu item **Call register**.

- **Missed calls**
- **Dialled numbers**
- **Received calls**

Voice mailbox

In the menu **Voice mailbox**, it is possible to set the number of the voice mailbox¹⁾ and then dial the number.

Bluetooth

The following menu items can be selected in the menu **Bluetooth**.

- **User** - the overview of the stored users
- **New user** - Search for new mobile phones that are in the reception range
- **Visibility** - Switching on the visibility of the telephone unit for other devices

- **Media player**
 - **Active device**
 - **Paired devices**
 - **Search**
- **Phone name** - the possibility to change the name of the telephone unit (pre-set SKODA UHV)

Settings

The following menu items can be selected in the menu **Settings**.

- **Phone book**
 - **Update**¹⁾
 - **List**
 - **Surname**
 - **First name**
- **Ring tone**

Back

Return in the Start menu of the telephone. ■

Universal telephone preinstallation GSM III

Introductory information

The universal telephone preinstallation GSM II ("hands-free system") includes a convenience mode for the mobile phone via voice control, the multifunction steering wheel, the radio or navigation system.

The universal telephone preinstallation GSM III comprises the following functions.

- Phone Phonebook » [page 109](#).
- Convenience operation via the multifunction steering wheel » [page 108](#).
- Operation of the telephone via the information display » [page 114](#).
- Voice control of the telephone » [page 116](#).
- Music playback from the telephone or other multimedia units » [page 118](#).
- Internet connection » [page 115](#).
- Display of SMS messages » [page 114](#). ▶

¹⁾ On vehicles fitted with the Amundsen+ navigation system, this function can be accessed via the navigation system menu; refer to the operating instructions for the Amundsen+ navigation system.

²⁾ This function is not available in vehicles fitted with the Amundsen+ navigation system.

All communication between a telephone and the hands-free system of your vehicle can only be established with the help of the following profiles of Bluetooth® technology.

rSAP - Remote SIM access profile

After connecting the telephone with the hands-free system via the **rSAP** profile, the telephone deregisters from the GSM network, and communication with the network is only enabled by the control unit via the vehicle's external aerial. In the telephone only the interface for Bluetooth® remains active. In this case, you can only use the mobile phone to disconnect from the hands-free system, deactivate the Bluetooth® connection or dial the emergency number 112 (only valid in some countries).

HFP - Hands Free Profile

After connecting the telephone with the hands-free system via the **HFP** profile, the telephone continues to use its GSM module and the internal antenna to communicate with the GSM network.

i Note

The following guidelines must be observed » [page 107](#), *Mobile phones and two-way radio systems*.

Connecting the phone to the hands-free system

To connect a mobile phone with the hands-free system, it is necessary to interconnect the telephone and hands-free system. Detailed information on this is provided in the operating instructions for your mobile phone. The following steps must be carried out for the connection.

Connecting the telephone with the hands-free system via the rSAP profile

- Activate Bluetooth® and the visibility of your mobile phone on your telephone. For certain mobile phones it is necessary to switch on first the **rSAP** function.
- Switch on the ignition.
- Select the menu **Phone - New user** in the information display and wait until the control unit has completed the search.
- Select your mobile phone from the menu of the units found.
- Within 30 seconds enter the 16-digit code that is shown on the information display and confirm it according to the instructions on the display of your mobile phone.

- If your SIM card is blocked by a PIN code, enter the PIN code for the SIM card in your phone. The telephone connects to the hands-free system (during the first connection you can only enter the PIN code in the information display when the vehicle is stationary, as this is the only situation when you can choose whether the PIN code should be stored).
- Follow the instructions in the information display, the first time a new user is stored.
- Reconfirm the **rSAP** command on your mobile phone to download the telephone book and the identification data from the SIM card into the control unit.

Connecting the telephone with the hands-free system via the HPP profile

- Activate Bluetooth® and the visibility of your mobile phone on your telephone.
- Switch on the ignition.
- Select the menu **Phone - New user** in the information display and wait until the control unit has completed the search.
- Select your mobile phone from the menu of the units found.
- Within 30 seconds enter the 16-digit code that is shown on the information display and confirm it according to the instructions on the display of your mobile phone.
- Follow the instructions on the information display and the mobile phone, to store a new user or to download the telephone book and identification data from the SIM card into the control unit.

The telephone primarily connects via the **rSAP** profile.

If the PIN code was stored, the telephone is automatically detected and connected with the hands-free system the next time the ignition is switched on. Check your mobile phone to see whether this automatic connection has been established.

Disconnecting the connection

- By removing the key from the ignition lock (the connection is disconnected during a telephone call).
- By disconnecting the hands-free system in the mobile phone.
- By disconnecting the user in the information display in the menu **Bluetooth - User - Select user - Disconnect**.

On vehicles which are fitted with a radio or navigation system at the factory, it is possible to terminate the telephone call after removing the key from the ignition lock by pressing the button on the touchscreen of the radio¹⁾ or navigation system; refer to the operating instructions for the radio or navigation system. ▶

¹⁾ Does not apply for Radio Swing.

i Note

- In the memory of the control unit, up to three users can be stored, whereby the hands-free system can only communicate actively with one user. If a connection is established with a fourth mobile phone, one of the users must be deleted.
- When connecting to the hands-free system, follow the instructions on your mobile phone.

Operate the telephone via the information display

If no telephone is connected with the hands-free system, after you select the **Phone** menu, the message **No paired phone found** will appear and the following menu items.

- **Help** - this menu item appears when no paired phone is stored in the memory of the control unit.
- **Connect** - this menu item appears when one or more paired phones are stored in the memory of the control unit.
- **New user**
- **Media player**
 - **Active device**
 - **Paired devices**
 - **Search**
 - **Visibility**
- **SOS**

If a telephone is coupled with the hands-free system, the following menu items can be selected in the menu **Phone**.

Phone book

In the menu point **Phone book** is the list of the loaded contacts from the telephone memory and the SIM card of the mobile phone.

The following functions are available for each phone contact.

- **Display telephone number**
- **Voice Tag**
 - **Replay**
 - **Record**

Dial number

Any telephone number can be entered in the menu point **Dial number**. The required numbers must be selected one after the other using adjustment wheel and confirmed by pressing the adjustment wheel. The numbers **0-9**, symbols **+**, *****, **#** and the functions **Delete**, **Call**, **Back** can be selected.

Call register

The following menu items can be selected in the menu item **Call register**.

- **Missed calls**
- **Received calls**
- **Dialled numbers**
- **Delete lists**

Voice mailbox

In the menu **Voice mailbox**, it is possible to set the number of the voice mailbox and then dial the number. The required numbers must be selected one after the other using adjustment wheel and confirmed by pressing the adjustment wheel. The numbers **0 - 9**, symbol **+** and the functions **Delete**, **Call**, **Save**, **Back** can be selected.

Messages¹⁾

The menu **Messages** comprises a list of received text messages. After calling a message, the following functions appear.

- **Show**
- **Read** - the system reads out the selected message through the vehicle's speakers
- **Send time**
- **Callback**
- **Copy** - copies the incoming message to the SIM card
- **Delete**

Bluetooth

The following menu items can be selected in the menu **Bluetooth**.

- **User** - the overview of the stored users
 - **Connect**
 - **Disconnect**
 - **Rename**
 - **Delete**
- **New user** - Search for users in the reception range
- **Visibility** - Switching on the visibility of the hands-free system for other devices ▶

¹⁾ Only applies when connecting the telephone with the hands-free system via the rSAP profile.

- **Media player**
 - **Active device**
 - **Paired devices**
 - **Connect**
 - **Rename**
 - **Delete**
 - **Authorisation**
 - **Search** - search for available media players
 - **Visibility** - Switching on the visibility of the hands-free system for media players in the vicinity
- **Extras**
 - **Modem** - overview of the active and paired devices for the connection to the internet
 - **Active device**
 - **Paired devices**
 - **Phone name** - the possibility to change the name of the hands-free system (pre-set SKODA UHV)

Settings

The following menu items can be selected in the menu **Settings**.

- **Phone book**
 - **Update** - scan the telephone book
 - **Select memory**
 - **SIM & phone**
 - **SIM card**
 - **Mobile phone** - Initial setting to also import contacts from the SIM card, it is necessary to switch to the menu item **SIM & phone**
 - **List**
 - **Surname**
 - **First name**
- **Own number** - optionally display your own telephone number on the display of the device of the person you are calling (this function is network-dependent)
 - **Network depnd. .**
 - **Yes**
 - **No**
- **Signal settings**
 - **Ring tone**
 - **Volume**
 - **Turn vol. up**
 - **Turn vol. down**

- **Phone settings**
 - **Select operator**
 - **Automatic**
 - **Manual**
 - **Network mode**
 - **GSM**
 - **Automatic**
 - **SIM mode** - valid for telephones with the rSAP profile, that simultaneously support the operation of two SIM cards - there is an option to choose which SIM card should be connected to the hands-free system
 - **Change**
 - **Phone Mode** - Toggle between rSAP and HFP mode
 - **Premium** - rSAP mode
 - **Hands-free** - HFP mode
 - **Off time** - Setting in five-minute steps
 - **Data** - Settings for the Internet access point - ask network operator for details
 - **Switch off ph. (Switch off ph.)** - switches off the phone unit (phone remains coupled)

Back

Return in the main menu of the information display. ■

Internet connection

A notebook can, for example, be connected to the Internet via the hands-free system.

The control unit of the hands-free system supports the GPRS, EDGE and UMTS/3G technologies.

An Internet can only be established via a telephone which is connected via the rSAP profile.

The procedure for connecting to the Internet can vary depending on the type and version of the operating system as well as the type of the device to be connected. Successfully connecting to the internet requires appropriate knowledge of the operating system for connecting the device .

Process of connection

- Connect the mobile phone with the hands-free system.
- Set the access point (depending on the operator, usually "Internet") in the menu **Phone - Settings - Data**.
- Switch on the visibility of the hands-free system for the other devices in the menu **Phone - Bluetooth - Visibility**. ►

- Use the device that is to be connected to search for available Bluetooth® devices.
- Select the hands-free system (as standard "SKODA_BT") from the list of found devices.
- Enter the password on the device being connected and follow any instructions given on this device or in the information display.
- Enter the desired Internet address in the Internet browser. The operating system requests the entry of the telephone number for the internet access (depending on the operator, usually "*99#").

Voice control

Dialogue

The period of time during which the system is ready to receive voice commands and to carry them out is called a dialogue. The system gives audible feedback and guides you if necessary through the relevant functions.

Optimum understanding of the voice commands depends on several factors.

- Speak with a normal tone of voice without intonation and excessive pauses.
- Avoid a bad pronunciation.
- Close the doors, windows and sliding roof, to reduce or stop disturbing exterior noise.
- It is recommended to speak louder at higher speeds, so that the tone of your voice is louder than the increased surrounding noise.
- During the dialogue, limit additional noise in the vehicle, e.g. passengers talking at the same time.
- Do not speak, if the system makes an announcement.



The microphone for voice control is inserted in the moulded headliner and directed to the driver and front passenger. Therefore the driver and the front passenger can operate the equipment.

Entering a phone number

The telephone number can be entered as a continuous series of individually spoken digits (the whole number at once) or in the form of digital blocks (separated by short pauses). After each order of digits (separation through brief voice pause) all of the digits detected up to now are repeated by the system.



The digits **0 - 9**, symbols **+**, *****, **#** are permitted. The system detects no continuous digit combinations such as twenty-three, but only individually spoken digits (two, three).

Activating voice control - GSM II



- by briefly pressing the button  » Fig. 107 on page 111 on the adapter¹⁾;
- by briefly pressing the button  on the multi-function steering wheel » page 108, *Operating the phone on the multifunction steering wheel.*

Deactivating voice control - GSM II

If the system is currently playing a message, the message that is currently being played will have to be stopped:

- by briefly pressing the button  on the adapter¹⁾,
- by briefly pressing the button  on the multifunction steering wheel.

If the system expects a voice command, you can end the dialogue yourself:

- with the **CANCEL** voice command;
- by pressing the button  on the adapter¹⁾;
- by briefly pressing the button  on the multifunction steering wheel.

Activating voice control - GSM III

The dialogue can be started at any time by pressing the button  on the multi-function steering wheel ¹⁾.

Deactivating voice control - GSM III

If the system is currently playing a message, you will need to end the message currently being played by pressing the  button on the multifunction steering wheel.

If the system expects a voice command, you can end the dialogue yourself:

- with the **CANCEL** voice command;
- by briefly pressing the button  on the multifunction steering wheel.

Note

- The dialogue of an incoming call is immediately interrupted.
- The voice control is only possible in vehicles fitted with a multifunction steering wheel with telephone control or a phone mount and adapter.
- On vehicles which are factory-fitted with the Columbus navigation system, it is only possible to operate the voice control for the telephone via this device; refer to the operating instructions for the Columbus navigation system.

¹⁾ Not valid for vehicles with the Columbus navigation system.

Voice commands - GSM II

Basic voice commands

Voice command	Action
HELP	After this command the system repeats all possible commands.
CALL XYZ	This command calls up the contact from the phone book.
PHONE BOOK	After this command, for example, the phone book can be repeated back to you, a voice entry for the contact can be updated or deleted, etc.
CALL HISTORY	Lists of dialled numbers, missed calls, etc.
DIAL NUMBER	After this command, a telephone number can be entered to establish a connection with the requested party.
REDIAL	After this command the system calls the last dialled number.
MUSIC^{a)}	Play music from the mobile phone or another paired device.
FURTHER OPTIONS	After this command the system offers additional context-dependent commands.
SETTINGS	Selection for setting Bluetooth [®] , dialogue etc.
CANCEL	The dialogue is ended.

^{a)} On vehicles fitted with the Amundsen+ navigation system, this function can be accessed via the navigation system menu; refer to the operating instructions for the Amundsen+ navigation system.

If a voice command is not detected, the system answers with "Sorry?" and a new entry can be completed. After the 2nd error the system repeats the aid. After the 3rd error the answer "Cancelled" is given and the dialogue is ended.

Store voice recording of a contact

If automatic name recognition does not work reliably for some contacts, you can choose to save your own voice entry for the contact in the menu **Phone book - Voice Tag - Record**.

Your own voice entry can also be saved using the voice control in the menu **FURTHER OPTIONS**.

Voice commands - GSM III

Basic voice commands

Voice command	Action
HELP	After this command the system repeats all possible commands.
CALL NAME	After this command, a name can be entered to establish a connection with the requested party.
DIAL NUMBER	After this command, a telephone number can be entered to establish a connection with the requested party.
REDIAL	The last selected telephone number is selected.
READ ADDRESSBOOK	The system reads out contacts from the telephone book.
READ MESSAGES	The system reads the messages which were received while the telephone was connected to the control unit.
SHORT DIALOGUE	The help is significantly reduced (good operating knowledge provided).
LONG DIALOGUE	The help is not reduced (suitable for beginners).
CANCEL	The dialogue is ended.

If the system does not recognise the command, it repeats the first part of the help thus enabling a new entry to be completed. After the 2nd error the system repeats the second part of the aid. After the 3rd error the answer "Cancelled" is given and the dialogue is ended.

Store voice recording of a contact

If automatic name recognition does not work reliably for some contacts, you can choose to save your own voice entry for the contact in the menu **Phone book - Voice Tag - Record**.

Your own voice entry can also be saved using the voice control in the menu **FURTHER OPTIONS**.

Multimedia

Music playback via Bluetooth®

The universal telephone preinstallation makes it possible to play back music via Bluetooth® from devices such as MP3 players, mobile phones or notebooks.

To ensure the music can be played back via Bluetooth®, it is necessary to connect the terminal device with the hands-free system in the menu **Phone - Bluetooth - Media player**.

The music playback process is performed on the connected device.

The universal telephone preinstallation GSM II ensures that the music played back via the hands-free system can be controlled with the remote control » [page 117](#), *Voice commands - GSM II*.

i Note

The device being connected must support the Bluetooth® A2DP profile; refer to the operating instructions for the relevant device being connected.

Operating the radio and navigation system on the multifunction steering wheel

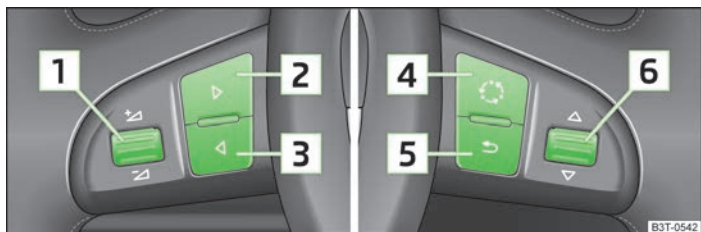

Fig. 108 Multifunction steering wheel: control buttons

The multifunction steering wheel comprises buttons for setting the basic functions for the factory-fitted radio and navigation system » [Fig. 108](#).

The radio and navigation system can of course still be operated on the devices. A description is included in the relevant operating instructions.

If the side lights are switched on, the buttons on the multifunction steering wheel are illuminated.

The buttons apply for the respective operating mode of the current radio or navigation system.

The following functions can be completed by pressing or turning the buttons.

Button	Action	Radio, traffic information	CD/CD changer/MP3	Navigation
1	Press briefly	Switch off/on tone or voice control ^{a)}		
1	Press button for a long period of time	switch off/on		
1	Turn upwards	Increase volume		
1	Turn downwards	Decrease volume		
2	Press briefly	Changing to the next stored radio station Changing to the next stored traffic information Interrupting the traffic report	Changing to the next title	
2	Press button for a long period of time	Interruption of the traffic report	Fast forward	

Button	Action	Radio, traffic information	CD/CD changer/MP3	Navigation
[3]	Press briefly	Changing to the previously stored radio station Changing to the previously stored traffic information Interrupting the traffic report	Changing to the previous title	
[3]	Press button for a long period of time	Interruption of the traffic report	Fast rewind	
[4]	Press briefly	changing the audio source		
[5]	Press briefly	Call up the main menu		
[6]	Press briefly	Interruption of the traffic report	without function	
[6]	Turn upwards	Display of the stored/accessible stations Scroll upwards Interruption of the traffic report	Changing to the previous title	without function
[6]	Turn downwards	Display of the stored/accessible stations Scroll downwards Interruption of the traffic report	Changing to the next title	

a) Only valid for the navigation system Columbus.

i Note

- The loudspeakers in the vehicle are adjusted to the power output of the radio and navigation system of 4x20°W.
- The sound system equipment comprises loudspeakers that are adjusted to the amplifier power output of 4x50°W + 6x25 W.

AUX-IN and MDI inputs

The AUX-IN input is located below the front armrest and is marked with **AUX**.

The input MDI is located in the storage compartment on the front passenger side.

The AUX-IN and MDI inputs are used to connect external audio sources (e.g. iPod or mp3 player) and to play back music from these devices via the factory-fitted radio or navigation system.

For a description of use, refer to the operating instructions for the relevant radio or navigation system.

CD change

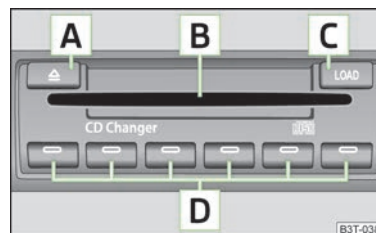

Fig. 109
The CD changer

The CD changer for the radio and navigation system is located in the left side compartment of the boot.

Inserting the CD

- Touch the button [C] » Fig. 109 and guide the CD (compact disc) into the CD-case [B]. The CD is automatically loaded onto the lowest free position in the CD changer. The warning light in the corresponding button [D] stops flashing. ➤

Filling the CD changer with CDs

- Press and hold the button **C** » Fig. 109 for longer than 2 seconds and guide the CDs one after the other (maximum 6 CDs) into the CD case **B**. The warning lights in the buttons **D** stop flashing.

Inserting a CD at a specific position

- Press the button **C** » Fig. 109. The warning lights in the buttons **D** illuminate the memory spaces that are already assigned and flash in the case of free memory spaces.
- Touch the desired button **D** and guide the CD into the CD-case **B**.

Ejecting a CD

- Press the button **A** » Fig. 109 to eject a CD. For assigned memory spaces, the warning lights now illuminate in the buttons **D**.
- Press the corresponding button **D**. The CD is ejected.

Ejecting all CDs

- Press and hold the button **A** » Fig. 109 for more than 2 seconds to eject the CDs. All CDs in the CD-changer are ejected consecutively.



Note

- Always guide the CD into the CD case **B** » Fig. 109 with the printed side facing upwards.
- Never force the CD into the CD case as it is drawn in automatically.
- After loading a CD into the CD changer, wait until the warning light of the corresponding button **D** is illuminated. Then the CD case **B** is free to load the next CD.
- If a position is selected, on which a CD is already located, this CD is ejected. Remove the ejected CD and load the desired CD. ■

Safety

Passive Safety

General information

Introduction

This chapter contains information on the following subjects:



Safety equipment _____	121
Before setting off _____	121
What influences the driving safety? _____	122

In this section you will find important information, tips and notes on the subject of passive safety in your vehicle. We have combined everything here which you should be familiar with, for example, regarding seat belts, airbags, child seats and safety of children. It is therefore important, in particular, to comply with the notes and warnings in this section for your own interest and in the interest of those travelling with you.

WARNING

- This chapter contains important information on how to use the vehicle for the driver and his occupants. You will find further information on safety, which concerns you and those travelling with you, in the following chapters of this Owner's Manual.
- The complete on-board literature should always be in the vehicle. This applies in particular, if you rent out or sell the vehicle.

Safety equipment

 First read and observe the introductory information and safety warnings  on page 121.

The following list contains part of the safety equipment in your vehicle:

- three-point seat belts for all the seats;
- belt force limiter for front and outer rear seats;

- belt tensioners for front seats;
- seat belt height adjusters for front seats;
- Front airbag for the driver and the front seat passenger;
- side airbags;
- head airbags;
- anchoring points for child seat using the ISOFIX system;
- anchoring points for child seat using the TOP TETHER system;
- head restraints adjustable for height;
- adjustable steering column.

The specified safety equipment works together, in order to optimally protect you and those travelling with you in accident situations. The safety equipment does not protect you or the people travelling with you, if you or your occupants adopt an incorrect seated position or the equipment is not correctly adjusted or used.

Before setting off

 First read and observe the introductory information and safety warnings  on page 121.

For your own safety and the safety of the people travelling with you, please pay attention to the following points before setting off.

- Ensure that the lighting and the turn signal system are functioning properly.
- Check the tyre inflation pressure.
- Ensure that all of the windows offer good visibility to the outside.
- Secure all items of luggage » page 60, *Boot*.
- Ensure that no objects can obstruct the pedals.
- Adjust the mirrors, the front seat and head restraint to your body size.
- Advise your passengers to adjust the head restraints to their body size.
- Protect children in suitable child seats with correctly fastened seat belts » page 135, *Transporting children safely*.
- Adopt the correct seated position » page 122, *Correct seated position*. Tell your passengers to assume the correct seated position.
- Correctly fasten the seat belt. Also inform passengers to fasten the seat belt correctly » page 125, *Seat belts*.

What influences the driving safety?



First read and observe the introductory information and safety warnings  on page 121.

The driver is fully responsible for himself and his occupants. If your driving safety is effected, you place yourself and the oncoming traffic at risk.

The following guidelines must therefore be observed.

- ▶ Do not get distracted from concentrating on the traffic situation, e.g. by your passengers or mobile phone calls.
- ▶ Never drive when your driving ability is impaired, e.g. through medication, alcohol, drugs.
- ▶ Keep to the traffic regulations and the permissible speed limit.
- ▶ Always adjust the driving speed to the road, traffic and weather conditions.
- ▶ Take regular breaks on long journeys – at least every two hours.

Correct seated position



Introduction

This chapter contains information on the following subjects:

Correct seated position for the driver	123
Correct seated position for the front passenger	123
Correct seated position for the occupants on the rear seats	123
Examples of an incorrect seated position	124



WARNING

- The front seats and the head restraints must always be adjusted to match the body size of the seat occupant as well as the seat belts must always be correctly fastened in order to provide an optimal protection for you and your occupants.
- Always assume the correct seated position before setting off and do not change this position while driving. Also advise your passengers to adopt the correct seated position and not to change this position while the car is moving.



WARNING (Continued)

- If the occupant adopts an incorrect seated position, he is exposed to life-threatening injuries, in case he is hit by a deployed airbag.
- If the occupants on the rear seats are not sitting upright, the risk of injury is increased due to incorrect routing of the seat belt.
- The driver must maintain a distance of at least 25 cm to the steering wheel. The front passenger must maintain a distance of at least 25 cm to the dash panel. Not maintaining this minimum distance will mean that the airbag system will not be able to properly protect you - hazard!
- When driving, hold the steering wheel with both hands firmly on the outer edge in the 9 o'clock and 3 o'clock position. Never hold the steering wheel in the 12 o'clock position or in any other way (e.g. in the middle or inner edge of the steering wheel). In such cases, you could severely injure the arms, hands and head when the driver airbag is deployed.
- The seat backrests must not be angled too far back when driving otherwise this will affect proper operation of the seat belts and of the airbag system - risk of injury!
- Ensure that there are no objects in the driver's footwell as they may get caught behind the pedals when driving or applying the braking. You would then no longer be able to operate the clutch, brake or accelerate.
- Always keep your feet in the footwell when the car is being driven - never place your feet on the instrument panel, out of the window or on the surfaces of the seats. You will be exposed to increased risk of injury if it becomes necessary to apply the brake or in the event of an accident. If an airbag is deployed, you may suffer fatal injuries when adopting an incorrect seated position!

Correct seated position for the driver

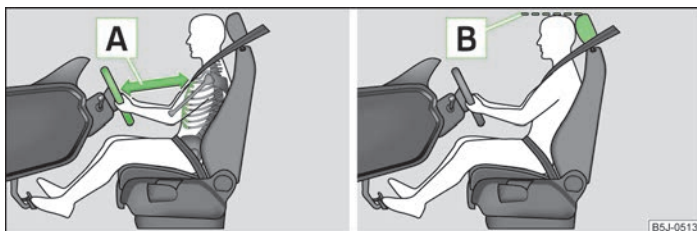

Fig. 110 The correct distance of the driver to the steering wheel/The correct head restraint adjustment

 First read and observe the introductory information and safety warnings  on page 122.

For your own safety and to reduce the risk of injury in the event of an accident, we recommend the following setting.

- Adjust the steering wheel so that the distance **A** » Fig. 110 between the steering wheel and your chest is at least 25 cm.
- Adjust the driver's seat in the forward/back direction so that the pedals can be fully depressed with slightly bent legs.
- Adjust the seat backrest so that the highest point of the steering wheel can be reached with your arms at a slight angle.
- Adjust the head restraint so that the top edge **B** of the head restraint is at the same level as the upper part of your head.
- Correctly fasten the seat belt » page 125, *Seat belts*.

Manual driver seat adjustment » page 55, *Manually adjusting the front seats*.

Electrical driver seat adjustment » page 55, *Adjusting front seats electrically*.

Correct seated position for the front passenger

 First read and observe the introductory information and safety warnings  on page 122.

For the safety of the front passenger and to reduce the risk of injury in the event of an accident, we recommend the following setting.

- Position the front passenger seat back as far as possible. The front passenger must maintain a distance of at least 25 cm to the dash panel so that the airbag offers the greatest possible safety if it is deployed.
- Adjust the head restraint such that the top edge of the head restraint is at the same level as the upper part of your head **B** » Fig. 110 on page 123.
- Correctly fasten the seat belt » page 125.

In exceptional cases the front passenger airbag can be deactivated » page 133, *Deactivating airbags*.

Manual front passenger adjustment » page 55, *Manually adjusting the front seats*.

Electrical front passenger seat adjustment » page 55, *Adjusting front seats electrically*.

Correct seated position for the occupants on the rear seats

 First read and observe the introductory information and safety warnings  on page 122.

To reduce the risk of injury in the event of a sudden braking manoeuvre or an accident, the occupants on the rear seats must observe the following.

- Adjust the head restraint such that the top edge of the head restraint is at the same level as the upper part of the head **B** » Fig. 110 on page 123.
- Correctly fasten the seat belt » page 125, *Seat belts*.
- Use a suitable child restraint system if transporting children in the vehicle » page 135, *Transporting children safely*.

Examples of an incorrect seated position



First read and observe the introductory information and safety warnings  on page 122.

Seat belts offer their optimum protection only if the webbing of the seat belts is properly routed. Incorrect seated positions considerably reduce the protective functions of the seat belts and therefore increase the risk of injury due to an incorrect routing of the seat belt. The driver is fully responsible for himself and passengers, especially children. Never allow a passenger to adopt an incorrect seated position when the car is moving.

The following list contains examples of which seated positions can cause serious injuries or death. This list is not complete, however we would like you to familiarise yourself with this subject.

Therefore, while the car is moving never:

- > stand up in the vehicle;
- > stand up on the seats;
- > kneel on the seats;
- > tilt the seat backrest fully to the back;
- > lean against the dash panel;
- > lie on the rear seat bench;
- > only sit on the front area of the seat;
- > sit to the side;
- > lean out of the window;
- > put the feet out of the window;
- > put the feet on the dash panel;
- > put the feet on the seat upholstery;
- > transport somebody in the footwell;
- > have the seat belt not fastened when driving;
- > be in the boot.

Seat belts

Seat belts

Introduction



Fig. 111
Driver wearing seat belt

This chapter contains information on the following subjects:

The physical principle of a frontal collision	126
Fastening and unfastening seat belts	127
Seat belt height adjuster on the front seats	128
Belt tensioners	128

Seat belts that are fastened correctly offer good protection in the event of an accident. They reduce the risk of an injury and increase the chance of survival in the event of a major accident.

Correctly fastened seat belts hold occupants of the car in the correct seated position » Fig. 111.

The seat belts reduce the kinetic energy (energy of motion) to a considerable extent. They also prevent uncontrolled movements which, in turn, may well result in severe injuries.

The occupants of a vehicle who have fastened and correctly adjusted their seat belt, profit to a major extent from the fact that the kinetic energy is optimally absorbed by the belts. The structure of the front end of the vehicle and other passive safety measures, such as the airbag system, also contribute to reducing the kinetic energy. The energy produced is thus absorbed and there is less risk of injury.

Particular safety aspects must be observed when transporting children in the vehicle » page 135.

! WARNING

- Fasten your seat belt before each journey - even when driving in town! This also applies to the people seated at the rear - risk of injury!
- Expectant women must also always wear a seat belt. This is the only way of ensuring optimal protection for the unborn child » page 127, *Fastening and unfastening seat belts*.
- Adjust the height of the belt in such a way that the shoulder part of the belt is roughly positioned across the middle of your shoulder - on no account across your neck.
- Always ensure that the webbing of the seat belts is properly routed. Seat belts which are not correctly adjusted can themselves cause injuries even in minor accidents.
- The maximum protection which seat belts can offer is only achieved if you are correctly seated » page 122, *Correct seated position*.
- The seat backrests of the front seats must not be tilted too far to the rear otherwise the seatbelts can lose their effectiveness.
- The belt webbing must not be jammed in-between at any point or twisted, or chafe against any sharp edges.
- Make sure you do not catch the seat belt in the door when closing it.
- A seat belt which is hanging too loose can result in injuries as your body is moved forward by the kinetic energy produced in an accident and is then suddenly held firm by the belt.
- The belt webbing must not run across solid or fragile objects (e.g. spectacles, ball-point pens, keys etc.) as this may be a cause of injuries.
- No two persons (also not children) should ever use a single seat belt together.
- The lock tongue should only be inserted into the lock which is the correct one for your seat. Wrong use of the safety belt will reduce its capacity to protect and the risk of injury increases.
- The slot of the belt tongue must not be blocked by paper or similar objects otherwise the belt tongue will not lock in place properly.
- Many layers of clothing and loose clothing (e. g. a winter coat over a jacket) do not allow you to be correctly seated and impairs proper operation of the seat belts.
- It is prohibited to use clamps or other objects to adjust seat belts (e. g. for shortening the belts for smaller persons).

! WARNING (Continued)

- The seat belts for the rear seats can only fulfil their function reliably when the seat backrests are correctly locked into position » [page 59, Rear seats](#).
- The belt webbing must always be kept clean. Soiled belt webbing may impair proper operation of the inertia reel » [page 154, Seat belts](#).
- The seat belts must not be removed or changed in any way. Do not attempt to repair the seat belts yourself.
- Check the condition of all the seat belts on a regular basis. If any damage to the seat belts, seat belt connections, inertia reel or the lock is detected, the relevant seat belt must be replaced by a ŠKODA specialist garage.
- Damaged seat belts which have been subjected to stress in an accident and were therefore stretched, must be replaced - this is best done by a ŠKODA specialist garage. The anchorage points for the belts should also be checked.

i Note

The national legal requirements must be observed when using seat belts.

The physical principle of a frontal collision

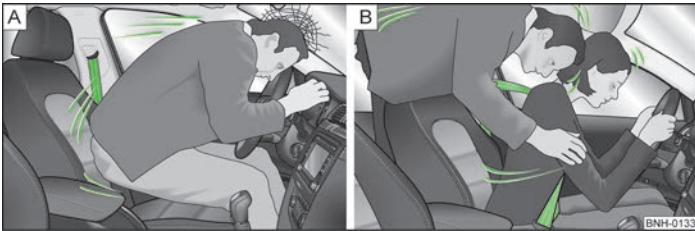



Fig. 112 Driver without a fastened seat belt/rear seat passenger without a fastened seat belt

 First read and observe the introductory information and safety warnings  on page 125.

The physical principle of a frontal collision can be explained quite simply.

As soon as the vehicle is moving, so-called kinetic energy (the energy of motion) is produced both in terms of the car as well as in terms of the occupants. The magnitude of this kinetic energy depends essentially on the speed at which the vehicle is travelling and on the weight of the vehicle including the occupants. The greater the speed and weight increase, the greater the amount of energy which has to be absorbed in the event of an accident.

The speed of the vehicle is, nevertheless, the most important factor. Doubling the speed of the vehicle from 25 km/h up to 50 km/hour increases the kinetic energy four times.

The common opinion that it is possible to support your body in a minor accident with your hands, is incorrect. Even in a collision at only a low speed, the forces acting on the body are such that it is no longer possible to support your body.

Even if you only drive at a speed of 30 km/h to 50 km/h, the forces that your body is exposed to in the event of an accident can exceed a tonne (1 000 kg).

In the event of a frontal collision, occupants of the car not wearing a seat belt, are thrown forward and strike in an uncontrolled way parts of the interior of the car, such as steering wheel, dash panel or windscreen » [Fig. 112 - A](#). In certain circumstances you could even be thrown out of the vehicle, which could cause life threatening or even fatal injuries.

It is also important that rear seat occupants fasten their seat belts as they will otherwise be thrown through the vehicle in an uncontrolled manner in the event of an accident A rear seat passenger who has not fastened the seat belt is a danger not only to himself but also for those seated at the front » [Fig. 112 - B](#).

Fastening and unfastening seat belts

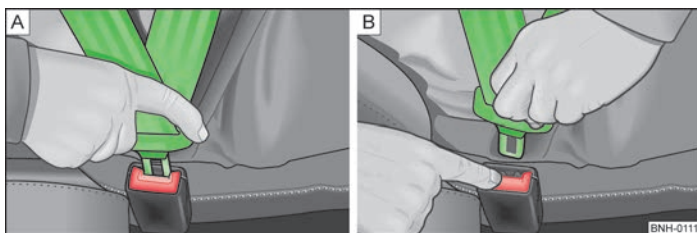

Fig. 113 Fastening/unfastening the seat belt

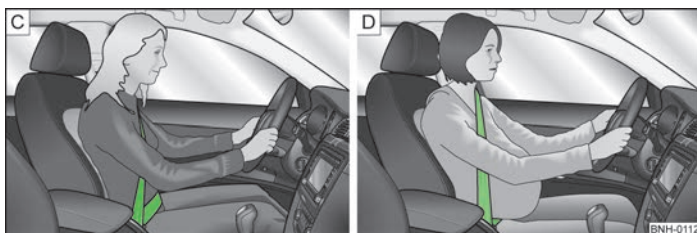



Fig. 114 Routing of belt webbing over the shoulders and the lap belt/Routing of belt webbing for an expectant mother

 First read and observe the introductory information and safety warnings  on page 125.

Fasten

- Correctly adjust the front seat and head restraint before fastening the seat belt » page 58, *Adjusting, removing and installing a head restraint*.
- Use the lock tongue to slowly pull the webbing over your chest and pelvis.
- Insert the lock tongue into the belt buckle » Fig. 113 - [A] that is part of the seat until it clicks into place.
- Pull on the belt to check that it has engaged correctly in the lock.

A plastic knob in the belt webbing holds the belt tongue in a position which is easy to get hold of.

It is important that the belt webbing is properly routed to ensure seat belts offer the maximum protection. The shoulder part of the seat belt must never run across the neck but must roughly run over the middle of the shoulder and fit snugly against the chest. The lap part of the belt must run across the pelvis, must not be positioned across the stomach and must always fit snugly » Fig. 114 - [C].

Expectant women must also always wear a seat belt. This is the only way of ensuring optimal protection for the unborn child. On expectant mothers, the lap part of the belt must be positioned as low as possible on the pelvis to avoid exerting any pressure on the lower abdomen » Fig. 114 - [D].

Release

Release the seat belt only when the vehicle is stationary.

- Press the red button in the belt buckle » Fig. 113 - [B], the lock tongue pops out.
- Manually guide the belt back so that it is easier to fully roll up the webbing, the seat belt does not twist.

Belt inertia reel

Each seat belt is equipped with an inertia reel. This inertia reel offers you complete freedom of movement if the belt is unreeled slowly. If the brakes are applied suddenly, the inertia reel will block. The belts also block when the car accelerates, when driving downhill and when cornering.

CAUTION

When releasing the seatbelt ensure that the tongue of the lock does not damage the door trim or other parts of the interior.

Seat belt height adjuster on the front seats

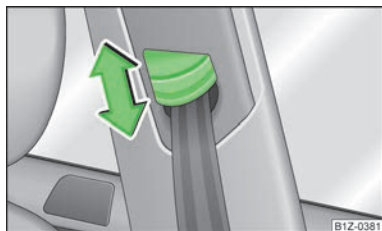



Fig. 115
Front seat: Seat belt height adjuster

 First read and observe the introductory information and safety warnings  on page 125.

The seat belt height adjuster makes it possible to adjust the routing of the front seat belts in the area of the shoulder to the body size.

- Press the height adjuster and move up or down in the desired direction » Fig. 115.
- Then pull firmly on the belt to ensure that the seat belt height adjuster has correctly locked in place.

Belt tensioners

 First read and observe the introductory information and safety warnings  on page 125.

Safety for the driver and front passenger **wearing their seat belts** is enhanced by the belt tensioners fitted to the inertia reels of the front three-point seat belts.

The three-point seat belts are automatically tensioned in the event of a frontal collision of a certain severity. The belt tensioners can also be deployed if the seat belts are not fastened.

The fastened three-point seat belts are automatically tensioned in the event of a frontal or side collision of a certain severity.

Belt tensioners are not activated in the event of minor frontal collisions, side and rear-end collisions, in the case of a rollover and also not in accidents in which no major forces are produced from the front.

WARNING

- Any work on the belt tensioner system including removal and installation of system components because of other repair work, must only be carried out by a ŠKODA specialist garage.
- The protective function of the system is only adequate for a single accident. If the belt tensioners have been deployed, it is then necessary to replace the entire system.

Note

- Smoke is generated when the belt tensioners are deployed. This is not an indication of a fire in the vehicle.
- When disposing of the vehicle or parts of the belt tensioner system, it is important to comply with national legal requirements. ŠKODA Service Partners are familiar with these regulations and will be able to provide you with detailed information.

Airbag system

Description of the airbag system

Introductory information





The operational readiness of the airbag system is monitored electronically. The airbag warning light  comes on for a few seconds each time the ignition is switched on » [page 24](#).

The airbags inflate in fractions of a second and at a high speed to offer additional protection in the event of an accident.

The airbag system (according to vehicle equipment) consists of:

- › an electronic control unit;
- › Front airbags for the driver and front seat passenger » [page 130](#);
- › side airbags » [page 131](#);
- › head airbags » [page 132](#);
- › an airbag warning light in the instrument cluster » [page 24](#);
- › a key switch for the front seat passenger airbag » [page 133](#);
- › an warning light in the middle of the dash panel to indicate the front seat passenger airbag is switched off » [page 133](#).

A fault in the airbag system exists if:

- › the warning light  does not illuminate when the ignition is switched on;
- › the warning light  does not go out 4 seconds after the ignition is switched on;
- › the warning light  goes out and comes on again after the ignition is switched on;
- › the warning light  comes on or flashes when driving;
- › the warning light in the middle of the dash panel for the deactivated front seat passenger airbag flashes.

WARNING

- The airbag is not a substitute for the seat belt, but instead forms part of the complete passive vehicle safety concept. **Please note that an airbag can only offer you optimal protection in combination with a seat belt which is fastened.**
- To ensure passengers are protected with the greatest possible effect when the airbag is deployed, the front seats must be correctly adjusted to match the body size » [page 122](#), *Correct seated position*.
- If you do not fasten the seat belts when driving, lean too far forward or adopt an incorrect seated position, you are exposing yourself to increased risk of injury in the event of an accident.
- If there is a fault, have the airbag system checked immediately by a ŠKODA specialist garage. Otherwise, there is a risk of the airbag not being activated in the event of an accident.
- No modifications of any kind must be made to parts of the airbag system. Any work on the airbag system including the installation and removal of system components due to other repair work (e.g. removal of the steering wheel) must only be carried out by a ŠKODA specialist garage.
- Never make any changes to the front bumper or bodywork.
- It is prohibited to manipulate individual parts of the airbag system as this might result in the airbag being deployed.
- The protective function of the airbag system is sufficient for only one accident. The airbag system must then be replaced if the airbag has been deployed.
- The airbag system needs no maintenance during its working life.
- If you sell your vehicle, provide the complete vehicle documentation to the new owner. Please note that the information relating to the possibility of deactivating the front passenger airbag must be included!
- When disposing of vehicle or parts of the airbag system, it is important to comply with the national legal requirements.

When are the airbags deployed?

The airbag system is only functional when the ignition is switched on.

In certain accident situations, the several airbags may be deployed simultaneously.

The airbags **are not deployed** in the case of **minor** frontal and side collisions, rear-end collisions, tilting of the vehicle and vehicle rollover. ►

Deployment factors

It is not possible to generally determine which deployment conditions apply to the airbag system in every situation. An important role is played by factors such as the type of object that the vehicle hits (hard, soft), the impact angle, vehicle speed, etc.

A decisive factor for the deployment of the airbags is the deceleration which occurs. The control unit analyses the nature of the collision and activates the relevant restraint system. If the vehicle deceleration which occurs and is measured during the collision remains below the prescribed reference values specified in the control unit, the airbags are not deployed although the vehicle may well suffer severe damage to the bodywork as a consequence of the accident.

The following will be deployed in the event of a severe frontal collision:

- driver's front airbag;
- passenger's front airbag.

The following will be deployed in the event of a severe side collision:

- front side airbag on the side of the accident;
- head airbags on the side of the accident.

In the event of an accident in which the airbags are deployed:

- the interior lighting comes on (if the switch for the interior light is in the door contact position),
- the hazard warning light is switched on;
- all the doors are unlocked;
- the fuel supply to the engine is interrupted.

i Note

A grey white or red, non-harmful gas is released when the airbag is inflated. This is perfectly normal and is not an indication of a fire in the vehicle.

Front airbags

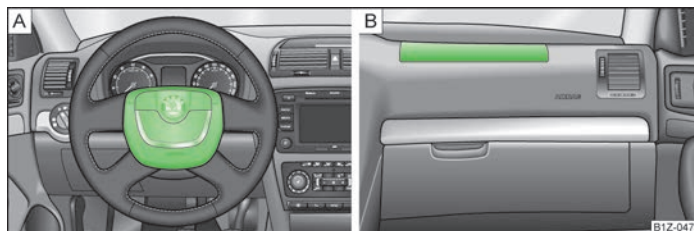

Fig. 116 Driver airbag in the steering wheel/front passenger airbag in the dashboard

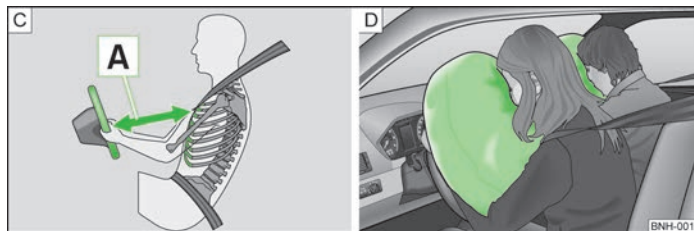

Fig. 117 Safe distance to steering wheel/inflated airbags.

In the event of a severe frontal collision, the front airbag system offers additional protection for the head and chest area of the driver and front passenger.

The front airbag for the driver is housed in the steering wheel » Fig. 116 - [A].

The front airbag for the front seat passenger is located in the dash panel above the stowage compartment [B] - » Fig. 116.

If the airbags are deployed, the airbags are filled with a propellant gas and inflated in front of the driver and front passenger » Fig. 117 - [D]. The forward movement of the driver and of the front passenger is cushioned when they make contact with the fully inflated airbag and the risk of injury to head and chest is thus reduced.

The airbag allows the gas to flow out of the inflated airbag in a controlled manner (depending on the load of the particular car occupant) in order to cushion head and chest areas. The airbag then deflates subsequently to such an extent, after an accident, to again provide a clear view forward.

! WARNING

- For the driver and front passenger, it is important to maintain a distance of at least 25 cm to the steering wheel or dashboard **A** » Fig. 117. Not maintaining this minimum distance will mean that the airbag system will not be able to properly protect you - hazard! The front seats and the head restraints must always also be correctly adjusted to match the body size of the occupant.
- The airbag develops enormous forces when triggered, which can lead to injuries if the sitting position or seated position is not correct.
- There must not be any further persons, animals or objects positioned between the front seated occupants and the deployment area of the airbag.
- Never transport children on the front seat of a vehicle without using a proper restraint system. If airbags are deployed in the event of an accident, the child might suffer severe or even fatal injuries!
- It is essential to always switch off the front passenger airbag when attaching a child safety seat to the front passenger seat where the child is seated with its back facing in direction of travel » page 133, *Deactivating airbags*. If this is not done, there is a risk of the child suffering severe or even fatal injuries if the front passenger airbag is deployed. When transporting a child on the front passenger seat, pay attention to any relevant national regulations regarding the use of child safety seats.
- The steering wheel and the surface of the airbag module in the dash panel on the passenger side must not have stickers attached, be covered or modified in any other way. These parts should only be cleaned with a cloth that is dry or has been moistened with water. No objects such as cup holders, mobile phone mounts, etc. must be attached to the covers of the airbag modules or be located within their immediate vicinity.
- Never place objects on the surface of the front passenger airbag module in the dash panel.

Side airbags

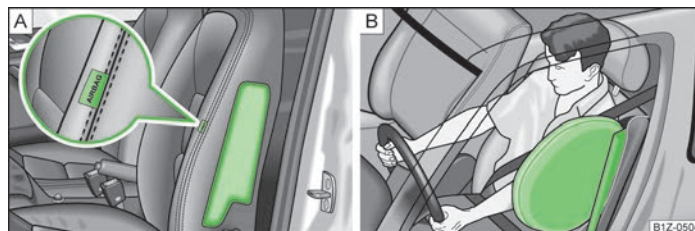

Fig. 118 Location of the side airbag in the driver's seat/gas-filled side airbag

In the event of severe side collisions, the side airbag system provides additional protection for the upper body (chest, stomach and pelvis) of passengers in the vehicle.

The side airbags are housed in the upholstery of the seat backrests of the front seats » Fig. 118 - **A**.

When the side airbags » Fig. 118 - **B** are deployed, the head airbag and belt tensioner are also automatically deployed on the relevant side.

The load of the occupants is cushioned when plunging into the fully inflated airbag and the risk of injury to the entire upper body (chest, stomach and pelvis) is reduced on the side facing the door.

! WARNING

- Your head should never be positioned in the deployment area of the side airbag. You might suffer severe injuries in the event of an accident. This applies in particular to children who are transported without using a suitable child safety seat » page 136, *Child safety and side airbag*.
- There must not be any further persons, animals as well as objects positioned between the occupants and the deployment area of the airbag. No accessories, such as cup holders, should be attached to the doors.
- If children adopt an incorrect seated position when travelling, they may be exposed to an increased risk of injury in the event of an accident. This can result in serious injuries » page 135, *Child seat*.

! WARNING (Continued)

- The airbag control unit operates with pressure sensors located in the front doors. For this reason no adjustments must be carried out to the doors and door panels (e.g. additional installation of loudspeakers). Resulting damages can have a negative effect on the operation of the airbag system. All work on the front doors and their panels must only be carried out by a ŠKODA specialist garage.
- In the event of a side collision, the side airbags will not function properly, if the sensors cannot measure the increasing air pressure inside the doors, because the air can escape through large, non-sealed openings in the door panel.
 - Never drive with removed inner door panels.
 - Never drive, if parts of the inner door panel have been removed and the remaining openings have not been properly sealed.
 - Never drive, if the loudspeakers in the doors have been removed, only if the loudspeaker openings have been properly sealed.
 - Always make sure that the openings are covered or filled, if additional loudspeakers or other equipment parts are installed in the inner door panels.
 - Always have work completed by a ŠKODA Service Partner or a competent ŠKODA specialist garage.
- Only hang light items of clothing on the hooks fitted in the vehicle. Never leave any heavy or sharp-edged objects in the pockets of the items of clothing.
 - Ensure that there are no excessive forces, such as violent knocks, kicks etc., impact on the backrests of the seats otherwise the system may be damaged. The side airbags would not be deployed in such a case!
 - Any seat or protective covers which you fit to the driver or front passenger seats must only be of the type expressly authorized by ŠKODA. In view of the fact that the airbag inflates out of the backrest of the seat, use of non-approved seat or protective covers would considerably impair the protective function of the side airbag.
 - Any damage to the original seat covers in the area of the side airbag module must be repaired without delay by your ŠKODA specialist garage.
 - The airbag modules in the front seats must not display any damage, cracks or deep scratches. It is not permissible to use force in order to open the modules.

Head airbags

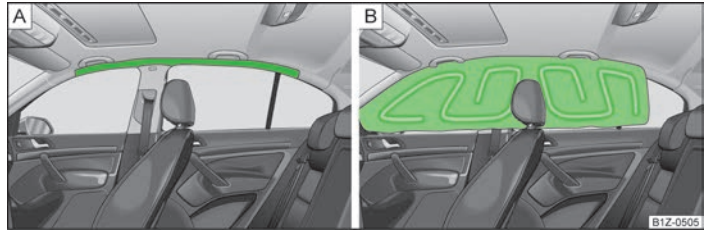

Fig. 119 Location of the head airbag/gas-filled head airbag

In the event of a severe side collision, the head airbag system offers additional protection for the head and neck area of passengers.

The head airbags are positioned above the doors on both sides in the interior of the car » Fig. 119 - **A**.

In the event of a **side collision** the head airbag is deployed together with the relevant side airbag and the belt tensioner on the side of the car on which the accident occurs.

When deployed, the airbags cover the entire side window and door pillar » Fig. 119 - **B**.

Any impact of the head against parts of the interior or objects outside of the car, is cushioned by the inflated head airbag. The reduction in any impact to the head and the resultant minimizing of any movements of the head additionally reduce the risk of injuries to the neck area. The head airbag also offers additional protection in the case of an offset impact by covering the front door pillar.

! WARNING

- There must not be any objects in the deployment area of the head airbags which might prevent the airbags from inflating properly.
- Only hang light items of clothing on the hooks fitted in the vehicle. Never leave any heavy or sharp-edged objects in the pockets of the items of clothing. Additionally, clothes hangers must not be used to hang up items of clothing.

! WARNING (Continued)

- The airbag control unit operates with sensors located in the front doors. For this reason no adjustments must be carried out to the doors and door panels (e.g. additional installation of loudspeakers). Resulting damages can have a negative effect on the operation of the airbag system. All work on the front doors and their panels must only be carried out by a ŠKODA specialist garage.
- There must no other persons (e.g. children) or animals between the passenger and the deployment area of the head airbag. In addition, none of the occupants should lean their head out of the window when driving, or extend their arms and hands out of the window.
- The sun visors must not be swivelled towards the side windows in the deployment area of the head airbags if any objects, such as ball-point pens, etc. are attached to them. This might result in injuries to the occupants if the head airbag is deployed.
- The installation of impermissible accessories in the vicinity of the head airbags can considerably impair the protection offered by the head airbag in the event of it being deployed. When the deployed head airbag is inflated, parts of the fitted accessories could be thrown into the interior of the car and injure the occupants » [page 177](#), *Accessories, changes and replacement of parts*.

Deactivating airbags

Deactivating airbags

Deactivation of airbags is envisaged only for particular instances, such as if:

- using a child seat on the front passenger seat, in which the child has its back to the vehicle's direction of travel (in some countries this must be in the direction of travel due to different legal regulations applying) » [page 135](#), *Transporting children safely*;
- not being able to maintain a distance of at least 25 cm between the middle of the steering wheel and chest, despite the driver's seat being correctly adjusted;
- special attachments are required in the area of the steering wheel because of a physical disability;
- other seats have been installed (e.g. orthopaedic seats without side airbags).

The front passenger airbag can be switched off with the key-operated switch » [page 133](#), *Key switch for the front seat passenger airbag*.

We recommend that you ask a ŠKODA Service Partner to switch off any other airbags.

Monitoring the airbag system

The functionality of the airbag system is monitored electronically even if one of the airbags is switched off.

If the airbag was switched off using diagnostic equipment:

- The airbag warning light  illuminates for around 4 seconds after the ignition is switched on and then flashes approximately another 12 seconds in 2 second intervals.

The following applies if the airbag has been switched off using the key switch in the storage compartment:

- The airbag warning light  comes on for around 4 seconds after the ignition is switched on;
- The deactivated airbag is indicated by the illumination of the warning light AIRBAG OFF in the middle of the dash panel » [Fig. 120](#) on [page 133](#) [3](#).

i Note

- The national regulations for switching off airbags must be observed.
- A ŠKODA Service Partner will be able to inform you which airbags in your vehicle can/must be deactivated.

Key switch for the front seat passenger airbag

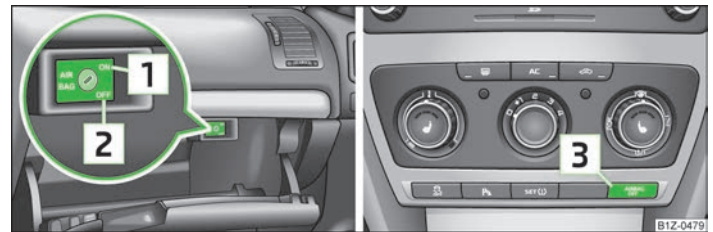

Fig. 120 Storage compartment: Key-operated switch for the front passenger airbag/warning light for front seat passenger airbag deactivation

Only the front passenger airbag is deactivated with the key switch.

Deactivating an airbag

- Switch off the ignition.
- Use the key to turn the slot of the key switch into position [2](#) » [Fig. 120 OFF](#). ▶

- › Check whether the warning light **AIRBAG OFF** in the middle of the dash panel **3** lights up when the ignition is switched on.

Activating an airbag

- › Switch off the ignition.
- › Use the key to turn the slot of the key switch into position **1** » Fig. 120 **ON**.
- › Ensure that the warning light **AIRBAG OFF** in the middle of the dash panel **3** does not light up when the ignition is switched on.

Warning light **AIRBAG OFF** (airbag switched off)

If the front passenger airbag is **switched off**, the warning light comes on for about 4 seconds after the ignition is switched on.

There is a system fault in the deactivated airbag » **!** if the airbag warning light flashes. **Immediately visit a ŠKODA specialist garage.**

! WARNING

- The driver is responsible for whether the airbag is switched on or switched off.
- Only switch off the airbag when the ignition is switched off! Otherwise a fault can occur in the system for deactivating the airbag.
- If the airbag warning light **AIRBAG OFF** (airbag switched off) flashes, the front passenger airbag will not be deployed in the event of an accident! Have the airbag system checked by a ŠKODA specialist garage immediately.

Transporting children safely

Child seat

Introduction

This chapter contains information on the following subjects:

Use of a child seat on the front passenger seat	135
Child safety and side airbag	136
Classification of child seats	136
Suitability of child seats	137
Child seats with the ISOFIX system	137
Child seat with the TOP TETHER system	137

Children are generally safer on the rear seats than on the front passenger seat.

In contrast to adults, the muscles and bone structure of children are not yet fully developed. Thus children are exposed to increased risk of injury.

Children should be transported in accordance with the relevant statutory provisions.

Child seats that comply with the ECE-R 44 standard must be used. The ECE-R Norm stands for: Economic Commission for Europe - Regulation.

Child seats that comply with the ECE-R 44 standard have a test seal that cannot be removed: a large E within a circle with the test number below.

! WARNING

- The national legal requirements must be observed when using child seats.
- One should never carry children, and also not babies! - on one's lap.
- Never leave children unattended in the vehicle. Certain outside climatic conditions can cause life-threatening temperatures in the vehicle.
- Under no circumstances allow children to be transported without the use of a suitable restraint system. In the event of an accident the child will be thrown through the vehicle and may as a result suffer fatal injuries, and also injure other occupants.

! WARNING (Continued)

- Children are exposed to an increased risk of injury in the event of an accident if they lean forward or adopt an incorrect seated position when the vehicle is moving. This particularly applies to children who are transported on the front passenger seat as they can suffer severe, or even fatal injuries if the air-bag system is deployed!
- Pay particular attention to the information provided by the manufacturer of the child safety seat regarding the correct routing of the belt. Seat belts which are not correctly adjusted can themselves cause injuries even in minor accidents.
- Safety belts must be checked to ensure that they are running properly. One should also ensure that the belt is not damaged by sharp-edged fittings.
- It is essential to switch off the front passenger airbag if using a child seat in which the child is seated with its back facing the direction of travel on the front passenger seat. Further information » [page 135](#), *Use of a child seat on the front passenger seat.*

i Note

We recommend that you use child seats from ŠKODA Original Accessories. These child seats were developed and also tested for use in ŠKODA vehicles. They fulfil the ECE-R 44 standard.

Use of a child seat on the front passenger seat

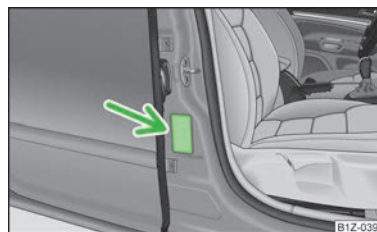

Fig. 121
Sticker on the B column on the front passenger side.



First read and observe the introductory information and safety warnings ! on page 135.

For safety reasons, we recommend that you install child seats on the rear seats whenever possible.

The following guidelines must be observed when using a child safety seat in which the child is seated with its back facing the direction of travel on the front passenger seat.

- Switch off the front passenger airbag » [page 133](#), *Deactivating airbags*.
- Slide the front passenger seat all the way back.
- Move the front passenger seat backrest into the vertical position.
- Set the height-adjustable front passenger seat as high up as possible.
- Adjust the seat belt for the front passenger seat so that it is as high as possible (not suitable for a child seat fastened with the ISOFIX system).
- Place and fasten the child seat on the seat and the child in the child seat according to the specifications in the manufacturer's user manual of the child seat.

! WARNING

- It is essential to always switch off the front passenger airbag when attaching a child safety seat to the front passenger seat where the child is seated with its back facing in direction of travel » [page 133](#), *Deactivating airbags*.
- **Never** use a child safety seat in which the child is seated with its back facing the direction of travel on the front passenger seat if the airbag is switched on. This child safety seat is positioned in the deployment area of the front passenger airbag. The airbag may cause the child severe, or even fatal injuries, in the event of it being deployed.
- This is also clearly stated on the sticker which is located on the B column on the front passenger side » [Fig. 121](#). The sticker is visible upon opening the front passenger door. For some countries, the sticker is also affixed to the sun visor of the front passenger.
- If a child safety seat in which the child faces in the direction of travel is used on the front passenger seat, the front passenger seat must be moved back and to the top fully. Move the backrest into the vertical position.
- The front passenger airbag must be reactivated as soon as you no longer use a child seat on the front passenger seat.

Child safety and side airbag

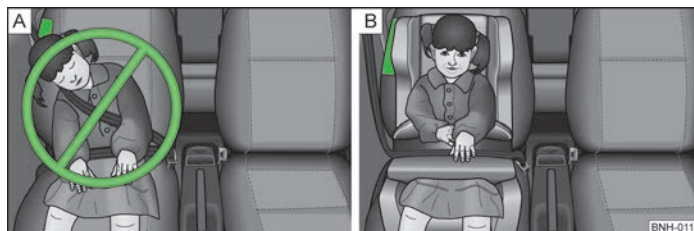

Fig. 122 Incorrect seated position of a child who is not properly secured - risk from the side airbag/Child properly protected by safety seat

First read and observe the introductory information and safety warnings ! on page 135.

The child must not be positioned in the deployment area of the side airbag » [Fig. 122 - A](#). There must be sufficient room between the child and the deployment area of the side airbag so that the airbag can provide as much protection as possible » [Fig. 122 - B](#).

! WARNING

- Children must never be seated with their head in the deployment area of the side airbag - risk of injury!
- Do not place any objects within the deployment area of the side airbags - risk of injury!

Classification of child seats

First read and observe the introductory information and safety warnings ! on page 135.







Child safety seats are classified in 5 groups:



Group	Weight of the child	Approximate age
0	0-10 kg	up to 9 months
0+	up to 13 kg	up to 18 months

Group	Weight of the child	Approximate age
1	9-18 kg	up to 4 years
2	15-25 kg	up to 7 years
3	22-36 kg	over 7 years

Suitability of child seats

 First read and observe the introductory information and safety warnings  on page 135.

Overview of the suitability of child seats according to the standard ECE-R 44	
Seat	Child seat type
Front passenger seat	 
Rear seat outside	  
Rear seat middle	 

-  Universal category – a child seat with the word UNIVERSAL, which is designed for fastening on the seat with the seat belt.
-  ISOFIX – a child seat which is designed for fastening on the seat with eyelets for the ISOFIX system is provided » page 137, *Child seats with the ISOFIX system*.
-  ISOFIX – a child seat which is designed for fastening on the seat with an eyelet for the TOP TETHER system is provided » page 137, *Child seat with the TOP TETHER system*.

Child seats with the ISOFIX system

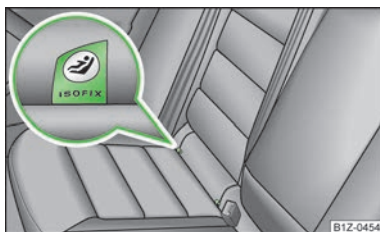

Fig. 123
Rear seat: ISOFIX

 First read and observe the introductory information and safety warnings  on page 135.

There are two fixing eyes between the seat backrest and the seat cushion of the front passenger seat for fixing the ISOFIX system child seat in place.

On the rear outside seats, the fixing eyes are located below the upholstery. The places are marked with labels with the ISOFIX logo » Fig. 123.

A child seat fitted with the ISOFIX system can only be mounted in a vehicle fitted with an ISOFIX system if the child seat has been approved for this type of vehicle. Further information is available from a ŠKODA Service Partner.

WARNING

- Always refer to the instructions from the manufacturer of the child seat when installing and removing a child seat with the ISOFIX system.
- Never attach other child seats, belts or objects to the locking eyes intended for the installation of a child seat with the ISOFIX system - hazard!

Note

Child seats with the ISOFIX system can be purchased from ŠKODA Original Accessories.

Child seat with the TOP TETHER system

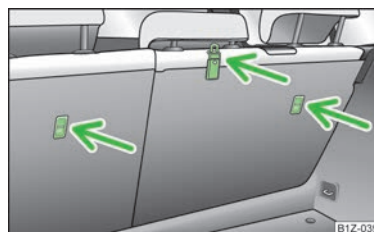



Fig. 124
Rear seat: TOP TETHER

 First read and observe the introductory information and safety warnings  on page 135.

There are fixing eyes on the rear side of the rear seat backrests for attaching the fixing belt for a child seat with the TOP TETHER system » Fig. 124.



WARNING

- Always refer to the instructions from the manufacturer of the child seat when installing and removing a child seat with the TOP TETHER system.
- Only use child seats with the TOP TETHER system on the seats with the locking eyes.
- Only ever attach one belt from the child seat to a locking eye.
- On no account should you equip your vehicle, e.g. mount screws or other anchorage points.

Driving Tips

Driving and the Environment

The first 1 500 km

New engine

The engine has to be run in during the first 1 500 kilometres.

Up to 1 000 kilometres

- Do not drive faster than 3/4 of the maximum speed of the gear in use, i.e. 3/4 of the maximum permissible engine speed.
- No full throttle.
- Avoid high engine speeds.
- Do not tow a trailer.

From 1 000 up to 1 500 kilometres

- **Gradually** increase the power output of the engine up to the full speed of the gear engaged, i.e. up to the maximum permissible engine speed.

During the first operating hours the engine has higher internal friction than later until all of the moving parts have harmonized. The driving style which you adopt during the first approx. 1 500 kilometres plays a decisive part in the success of running in your car.

Never drive at unnecessarily **high engine speeds** even after the running-in period is complete. The maximum permissible engine speed is marked by the start of the red scale area of the revolutions counter. On vehicles fitted with a manual gearbox, at the very latest shift up into the next gear when the red area is reached. During acceleration (depressing the accelerator) **exceptionally** high engine speeds are automatically reduced, yet the engine is not protected against too high engine speeds which are caused by incorrectly shifting down the gears resulting in a sudden increase of the engine speeds above the permitted maximum revolutions which can lead to engine damage.

For a vehicle fitted with a manual gearbox the converse situation also applies: Do not drive at an engine speed that is too **low**. Shift down a gear when the engine is no longer running smoothly. Observe the recommended gear » [page 11](#), *Recommended gear*.

CAUTION

All the speed and engine revolution figures apply only when the engine is at its normal operating temperature. Never rev up a cold engine when the vehicle is stationary or when driving in individual gears.



For the sake of the environment

Not driving at unnecessarily high engine revolutions and shifting to a higher gear as early as possible are ways to minimise fuel consumption and operating noise levels and protects the environment.

New tyres

New tyres have to be "run in" since they do not offer optimal grip at first. Drive especially carefully for the first 500 km or so.

New brake pads

New brake pads initially do not provide full braking efficiency. The brake pads must initially be "run in". Drive especially carefully for the first 200 km or so.

Catalytic converter

Proper operation of the emission control system (catalytic converter) is of major significance for driving your vehicle in an environmentally conscious way.

The following guidelines must be observed:

- Vehicles fitted with a petrol engine must always be refueled with unleaded petrol » [page 156](#), *Unleaded petrol*;
- Do not pour too much oil into the engine » [page 161](#), *Checking the engine oil level*;
- Do not switch off the ignition while driving.

If you drive your vehicle in a country in which unleaded petrol is not available, you must have the catalytic converter replaced later when driving the vehicle into a country in which use of a catalytic converter is mandatory.

! WARNING

- In view of the high temperatures which can be produced in the catalytic converter, the vehicle should be parked in such a way that the catalytic converter cannot come into contact with easily flammable materials under the vehicle - risk of fire!
- Never use additional underbody protection or anti-corrosion agents for exhaust pipes, catalytic converters or heat shields - risk of fire!

! CAUTION

- Never drive until the fuel tank is completely empty! The irregular supply of fuel can cause misfiring, which can result in considerable damage to parts of the engine and exhaust system.
- Just filling the tank with leaded petrol once will damage the exhaust system!

Economical and environmentally friendly driving

Introductory information

Your fuel consumption, any pollution of the environmental and the wear-and-tear to the engine, brakes and tyres, depend essentially on three factors:

- your personal style of driving;
- the conditions under which your vehicle is operated;
- technical aspects.

The fuel economy can be improved by 10 -15 % by always looking ahead and driving in an economical way.

Fuel consumption is also influenced by external factors which are beyond the driver's control. Consumption increases during the winter or under difficult conditions, on poor roads, etc.

Fuel consumption can vary considerably from the manufacturer's data, as a result of outside temperatures, the weather and driving style.

The technical requirements for low fuel usage and economic efficiency of the vehicle have already been built into the vehicle at the works. ŠKODA places a particular emphasis on minimising negative effects on the environment. It is necessary to take note of the guidelines given in this chapter in order to make best use of these characteristics and to maintain their effectiveness.

The optimal engine speed should be obtained when accelerating, in order to avoid a high fuel consumption and resonance of the vehicle.

Looking ahead when driving

A vehicle's highest fuel consumption occurs when accelerating, therefore unnecessary accelerating and braking should be avoided. If looking ahead when driving, less braking and consequently less accelerating are required. If possible, let your vehicle coast to a stop, or use the engine brake, if you can see that the next set of traffic lights is on red, for example.

Shifting to save energy

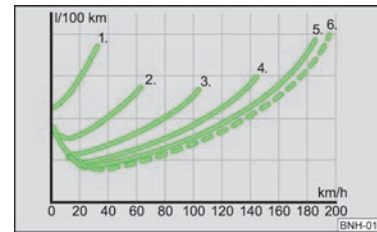

Fig. 125
Principle sketch: Fuel consumption in litres/100 km depending on the selected gear

Shifting up early saves on fuel.

Manual gearbox

- Drive no more than about one length of your vehicle in first gear.
- Shift up into the next gear at approx. 2 000 revolutions.

An effective way of achieving good fuel economy is to shift up **early**. Observe the recommended gear » [page 11, Recommended gear](#).

A suitably selected gear can have an effect on fuel consumption » [Fig. 125](#).

Automatic gearbox

- **Slowly** apply the accelerator pedal. However, do not depress it to the kickdown position.
- If the accelerator pedal is only depressed slowly on a vehicle fitted with an automatic gearbox, an economic driving programme is automatically selected. ▶

i Note

Observe the recommended gear » [page 11, Recommended gear.](#)

Avoiding full throttle

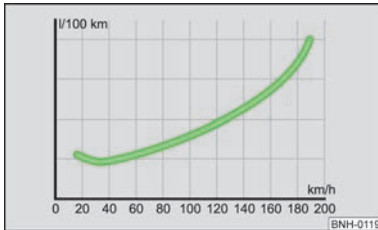

Fig. 126
Principle sketch: Fuel consumption in litres/100 km. and speed in km/h.

Driving more slowly means saving fuel.

Sensitive use of the accelerator will not only significantly reduce fuel consumption but also positively influence environmental pollution and wear of your vehicle.

The maximum speed of your vehicle should, as far possible, never be used. Fuel consumption, pollutant emissions and vehicle noises increase disproportionately at high speeds.

The » [Fig. 126](#) shows the ratio of fuel consumption to the speed of your vehicle. Fuel consumption will be halved if only three-quarters of the possible top speed of your vehicle is used.

Reducing idling

Idling also costs fuel.

In vehicles not equipped with the START-STOP system, turn off the engine when in a traffic jam, at a level crossing or traffic lights with longer wait times. Even after just 30 - 40 seconds you will have saved more fuel than that is needed when you start the engine up again.

If an engine is only idling it takes much longer for it to reach its normal operating temperature. Wear-and-tear and pollutant emissions, though, are particularly high in the warming-up phase. Therefore, start driving as soon as the engine has started, whereby high engine speeds should be avoided.

Regular servicing

A poorly tuned engine uses an unnecessarily high amount of fuel.

By having your vehicle regularly maintained by a ŠKODA specialist garage, you create the conditions needed for driving economically. The maintenance state of your vehicle has a positive effect on traffic safety and value retention

A poorly tuned engine can result in a fuel consumption which is 10 % higher than normal.

Also check the **oil level** when refuelling. **Oil consumption** is dependent to a considerable extent on the load and speed of the engine. Oil consumption could be as high as 0.5 litres/1 000 km depending on your style of driving.

It is quite normal that a new engine has a higher oil consumption at first, and reaches its lowest level only after a certain running in time. The oil consumption of a new vehicle can therefore only be correctly assessed after driving about 5 000 km.



For the sake of the environment

- Additional improvements to the fuel economy can be made by using synthetic high-lubricity oils.
- Regularly check the ground under the vehicle. Have your vehicle inspected by a ŠKODA specialist garage if you find any stains caused by oil or other fluids on the floor.

i Note

We recommend that your vehicle is serviced on a regular basis by a ŠKODA Service Partner.

Avoid short distances

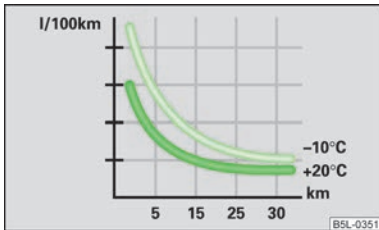

Fig. 127
Principle sketch: Fuel consumption in l/100 km at different temperatures

Short distances result in an above-average high fuel consumption. We therefore recommend avoiding distances of less than 4 km if the engine is cold.

A cold engine consumes the most fuel immediately after the start. Fuel consumption drops to 10 litres/100 km after just 1 kilometre. The consumption stabilises once the engine and catalytic converter have reached their operating temperature.

An important factor in this connection is also the **ambient temperature**. The image » Fig. 127 shows the different levels of fuel consumption after driving a certain distance at a temperature of +20 °C and a temperature of -10 °C. Your vehicle has a higher fuel consumption in the winter than in the summer.

Checking tyre inflation pressures

Tyres which are correctly inflated save fuel.

Always ensure the tyre inflation pressure is correct. The rolling resistance will be increased if the tyre filling pressure is too low. This will not only increase fuel consumption but also tyre wear and the driving behaviour will worsen.

Always check the tyre inflation pressure when the tyres are **cold**.

Avoid unnecessary ballast

Transporting ballast costs fuel.

Each kilogramme of **weight** increases the fuel consumption. It is worth checking the boot to avoid transporting any unnecessary ballast.

It is particularly in town traffic, when one is accelerating quite often, that the vehicle weight will have a significant effect upon the fuel consumption. A rule of thumb here is that an increase in weight of 100 kilograms will cause an increase in fuel consumption of about 1 litre/100 kilometres.

At a speed of 100 - 120 km/h, your vehicle that is fitted with a roof rack cross member without a load will use about 10 % more fuel than normal due to the increased aerodynamic drag.

Saving electricity

When the engine is running, the alternator generates and supplies electrical power. If more electrical components of the electrical system are switched on, more fuel is needed to operate the alternator. We therefore recommend switching off electrical components if these are no longer required.

Environmental compatibility

Environmental protection has played a major role in the design, selection of materials and manufacture of your new ŠKODA. Particular emphasis has been placed on the following points:

Design measures

- › Joints designed to be easily detached.
- › Simplified disassembly due to the modular structure system.
- › Improved purity of different classes of materials.
- › Identification of all plastic parts in accordance with VDA Recommendation 260.
- › Reduced fuel consumption and exhaust emission CO₂.
- › Minimum fuel leakage during accidents.
- › Reduced noise.

Choice of materials

- › Extensive use of recyclable material.
- › Air conditioning filled with CFC-free refrigerant.
- › No cadmium.
- › No asbestos.
- › Reduction in the "vaporisation" of plastics.

Manufacture

- › Solvent-free cavity protection.
- › Solvent-free protection of the vehicle for transportation from the production plant to the customer.

- › The use of solvent-free adhesives.
- › No CFCs used in the production process.
- › Without use of mercury.
- › Use of water-soluble paints.

Trade-in and recycling of old cars

ŠKODA meets the requirements of the brand and its products with regard to protecting the environment and the preserving resources. All new ŠKODA vehicles can be utilized up to 95 % and always ¹⁾ be returned. In a lot of countries sufficient trade-in networks have been created, where you can trade-in your vehicle. After you trade-in your vehicle, you will receive a confirmation stating the recycling in accordance with environmental regulations.

i Note

Detailed information about the trade-in and recycling of old cars is available from a ŠKODA Service Partner.

Driving abroad

Introductory information

In certain countries it is also possible that the ŠKODA Service Partner network is limited or has not been established yet. This is the reason why procuring certain spare parts may be somewhat complicated and specialist garages may only be able to make limited repairs. ŠKODA in the Czech Republic and its importers are happy to provide information about technical aspects of the vehicle, required maintenance work and possibilities for getting repairs done.

Unleaded petrol

A vehicle fitted with a petrol engine must always be refuelled with unleaded petrol » [page 156](#), *Unleaded petrol*. Information regarding the locations of filling stations that offer unleaded petrol is, for example, provided by the automobile associations.

Headlights

The low beam of your headlights is set asymmetrically. It illuminates the side of the road on which the vehicle is being driven to a greater extent.

When driving in countries in which the traffic drives on the other side of the road than in your home country, the asymmetrical low beam may dazzle oncoming drivers. To prevent oncoming traffic from being dazzled, the headlights must be adjusted by a ŠKODA Service Partner.

Headlights with Xenon lights are adjusted in the menu of the information display » [page 15](#), *MAXI DOT (information display)*.

i Note

Further information on adjusting the headlights is available from a ŠKODA Service Partner.

Avoiding damage to your vehicle

To prevent damage to your vehicle, pay special attention:

- › When driving on poorly maintained roads and lanes
- › When driving over kerb stones
- › When driving up steep ramps
- › So that any low-slung parts, such as the spoiler and exhaust, do not touch the ground and get damaged

This particularly applies to models with a sport suspension and also when your vehicle is fully laden.

¹⁾ Subject to fulfilment of the national legal requirements.

Driving through water on the street

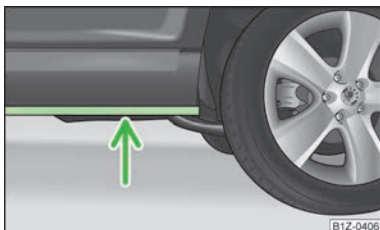

Fig. 128
Driving through water

The following must be observed to avoid damage to the vehicle when driving through bodies of water (e.g. flooded roads):

- Therefore determine the depth of the water before driving through bodies of water. The water level must fit around the strut on the side member as a maximum » Fig. 128;
- Do not drive any faster than at a walking speed. At a higher speed, a water wave can form in front of the vehicle which can cause water to penetrate into the air induction system of the engine or into other parts of the vehicle;
- Never stop in the water, do not reverse and do not switch the engine off;
- Deactivate the START-STOP system before driving through water » page 100, START/STOP.

! WARNING

- Driving through water, mud, sludge etc. can reduce the braking power and extend the braking distance - risk of accident!
- Avoid abrupt and sudden braking immediately after water crossings.
- After driving through bodies of water, the brakes must be cleaned and dried as soon as possible by intermittent braking. Only apply the brakes for the purpose of drying and cleaning the brake discs if the traffic conditions permit this. Do not place any other road users in jeopardy.

! CAUTION

- When driving through bodies of water, parts of the vehicle such as the engine, gearbox, chassis or electrics can be severely damaged.
- Oncoming vehicles can generate water waves which can exceed the permissible water level for your vehicle.

- Potholes, mud or rocks can be hidden under the water making it difficult or impossible to drive through the body of water.
- Do not drive through salt water. The salt can lead to corrosion. Any vehicle parts that have come into contact with salt water must be rinsed immediately with fresh water.

i Note

After driving through a body of water, we recommend that the vehicle is checked by a ŠKODA specialist garage. ■

Towing a trailer

Towing a trailer

Technical requirements

If your vehicle has already been factory-fitted with a towing device or is fitted with a towing device from ŠKODA Original Accessories, then it meets all of the technical requirements and national legal provisions for towing a trailer.

On vehicles with a towing device, the ball rod is detachable and is stowed together with separate operating instructions in the spare wheel well or in the compartment for the spare wheel within the boot » [page 179](#), *Vehicle tool kit*.

Your vehicle is fitted with a 13-pin power socket for the electrical connection between the vehicle and trailer. If the trailer that is to be towed has a **7-pin connector**, you can use a suitable adapter from ŠKODA Original Accessories.

If a towing device is retrofitted, it must be completed in accordance with the manufacturer's specifications.

Note

If you have any questions, please contact a ŠKODA Service Partner.

Loading a trailer

Loading a trailer

The vehicle/trailer combination must be balanced, whereby the maximum permissible drawbar load must be utilised. If the drawbar load is too low, it jeopardises the performance of the vehicle/trailer combination.

Distribution of the load

Distribute the load in the trailer in such a way that heavy items are located as close to the axle as possible. Secure the items from slipping.

The distribution of the weight is very poor if your vehicle is unladen and the trailer is laden. Maintain a particularly low speed if you cannot avoid driving with this combination.

Tyre pressure

Correct the tyre inflation pressure on your vehicle for a "full load" » [page 171](#), *Service life of tyres*.

Trailer load

The permissible trailer load must not be exceeded under any circumstances » [page 197](#), *Technical data*.

The trailer loads specified apply only to **altitudes** up to 1 000 metres above mean sea level. As the engine output drops at an increasing altitude due to the declining air pressure and therefore the climbing ability is also reduced, this means that the maximum permissible towed weight must be reduced by 10 % for every further increase of 1 000 m in height. The towed weight comprises the actual weight of the (loaded) towing vehicle and the (loaded) trailer. Always drive particularly carefully with the trailer.

The trailer and drawbar load information on the type plate of the towing device are merely test data for the towing device. The vehicle-specific values are detailed in the vehicle documents.

WARNING

- If the maximum permissible axle and drawbar load and the maximum permissible total or towed weight of the vehicle and the trailer are exceeded this can cause accidents and serious injuries.
- Slipping loads can significantly affect the stability and safety of the vehicle/trailer combination, causing accidents and serious injuries.

Towing a trailer

Exterior mirrors

You have to have additional exterior mirrors fitted if you are not able to see the traffic behind the trailer with the standard rear-view mirrors. The national legal requirements must be observed.

Headlights

The headlight settings must be checked before starting a journey with a coupled trailer. If necessary, adjust the settings with the headlight beam adjustment » [page 44](#), *Headlight beam adjustment* .

Driving speed

For safety reasons, do not drive faster than the maximum permissible speed indicated on the trailer. ▶

Immediately reduce your speed as soon as even the slightest swaying of the trailer is detected. Never attempt to stop the trailer from "swaying" by accelerating.



Brakes

Apply the brakes in good time! If the trailer is fitted with a **trailer brake**, apply the brakes gently at first, then brake firmly. This will avoid brake jolts resulting from the trailer wheels locking. On downhill sections shift down a gear in good time to also use the engine as a brake.

Trailer stabilisation

The trailer stabilisation is an extension of the stabilisation control that works in conjunction with the counter-steering assistance to reduce the amount the trailer "sways". After turning on the ignition, the ESC warning light  in the instrument cluster lights up for about 2 seconds longer than the ABS warning light.

Prerequisites for stabilising the trailer.

- The towing device is factory-fitted or a compatible towing device has been retrofitted.
- The ESC is active. The warning light  or  in the instrument cluster is not illuminated.
- The trailer is electrically connected to the towing vehicle by means of the trailer socket.
- The speed is higher than approx. 60 km/h.
- Trailers must have a fixed drawbar.
- The ESC works for both braked and unbraked trailers.

Trailer is connected to the anti-theft alarm system.

- If the vehicle is factory-fitted with an anti-theft alarm system and a towing device.
- If the trailer is electrically connected to the towing vehicle by means of the trailer socket.
- If the electrical system of the vehicle and trailer is fully functional.
- If the vehicle is locked with the car key and the anti-theft alarm system is activated.

When the vehicle is locked, the alarm is activated as soon as the electrical connection to the trailer is interrupted.

Always deactivate the anti-theft alarm system before a trailer is connected/disconnected. Otherwise, the anti-theft alarm system could accidentally be triggered » [page 31](#), *Anti-theft alarm system*.

Engine overheating

If the needle for the coolant temperature gauge moves into the right-hand area or the red area of the scale, the speed must be reduced immediately. Stop and switch off the engine if the warning light  in the instrument cluster starts to flash. Wait a few minutes and check the level of coolant in the coolant expansion bottle » [page 163](#), *Checking the coolant level*.

The following guidelines must be observed » [page 20](#), *Coolant temperature/coolant level* .

The coolant temperature can be reduced by switching on the heating.

! WARNING

- The increased safety offered by the trailer stabilisation must not tempt you to take greater risks than otherwise.
- Adapt your speed to the conditions of the road surface and to the traffic situation.
- Improper or incorrectly connected electric cables can energise the trailer and cause functional faults to the vehicle's entire electrical system as well as accidents and severe injuries.
- Any work on the electrical system must be carried out only by ŠKODA specialist garages.
- Never directly connect the trailer's electrical system with the electrical connections for the tail lights or other current sources.

! CAUTION

- The trailer stabilisation need not be able to correctly detect all of driving situations.
- Trailers that sway slightly are not always detected by the trailer stabilisation and thus are not stabilised accordingly.
- Release the pressure on the accelerator pedal if the system is being regulated.
- Avoid abrupt and sudden driving/braking manoeuvres.
- When the ball rod is removed, the mounting shaft must be sealed with an appropriate cover. This prevents foreign matter from penetrating into the mounting shaft. See the fitting instructions for the towing device. ▶

i Note

- We recommend that you also have your vehicle inspected between service intervals if you tow a trailer frequently.
- The handbrake on the towing vehicle must be put on when coupling and decoupling the trailer.
- For technical reasons, trailers with rear LED lights cannot be connected to the anti-theft alarm system. ■

General Maintenance

Taking care of and cleaning the vehicle

Taking care of your vehicle

Introduction

This chapter contains information on the following subjects:

Washing the vehicle	149
Automatic car wash systems	149
Washing by hand	149
Washing with a high-pressure cleaner	149
Preserving and polishing the vehicle paintwork	150
Chrome parts	150
Paint damage	150
Plastic parts	150
De-icing windows and exterior mirrors	151
Radio reception and aerial	151
Headlight lenses	151
Rubber seals	151
Door lock cylinders	151
Wheels	152
Underbody protection	152
Protection of hollow spaces	152
Artificial leather and materials	153
Fabric covers on electrically heated seats	153
Natural leather	153
Seat belts	154

Regular and proper care help to retain the efficiency and **value** of your vehicle. It may also be one of the requirements for the acceptance of warranty claims relating to corrosion damage and paint defects on the bodywork.

We recommend using care products from ŠKODA Original Accessories that are available from ŠKODA Service Partners. The instructions for use on the package must be observed.

WARNING

- Care products may be harmful to your health if not used according to the instructions.
- Always store care products in a safe place, out of the reach of children - risk of poisoning!
- When washing your vehicle in the winter: Water and ice in the brake system can affect the braking efficiency - risk of accident!
- Only wash the vehicle when the ignition is switched off - risk of accident!
- Protect your hands and arms from sharp-edged metal parts when cleaning the underfloor, the inside of the wheel housings or the wheel trims - risk of cuts!
- Air fresheners and scents can be hazardous to health when the temperature inside the vehicle is high.

CAUTION

- Be sure to check clothing for colourfastness to avoid any damage or visible stains on the material (leather), panels and textiles.
- Cleaners containing solvents can damage the material being cleaned.
- Do not wash your vehicle in bright sunlight - risk of paint damage.
- If washing the vehicle in the winter using a hose or high-pressure cleaner, ensure that the jet of water is not aimed directly at the locking cylinders or the door/panel joints - risk of freezing!
- Do not use any insect sponges, rough kitchen sponges or similar cleaning products - risk of damaging the surface of paintwork.
- Do not stick any stickers on the inside of the rear windows, the rear side windows and in the vicinity of the heating elements on the windscreen or near the window aerial. These may get damaged. With regard to the antenna, they may interfere with the radio or navigation system.
- Do not clean the inside of the windows with sharp-edged objects or corrosive and acidic cleaning agents - risk of damaging the heating elements or window aerial.
- Do not attach scents and air fresheners to the dashboard - risk of damage to the dashboard.
- To avoid damaging the parking aid sensors while cleaning with high-pressure cleaners or steam jets, the sensors must only be directly sprayed for short periods while a minimum distance of 10 cm must be observed.
- Do not clean the roof trim with a brush - risk of damage to the trim surface. ▶



For the sake of the environment

- Used cans of vehicle care products represent a special type of hazardous waste. These must be disposed of in accordance with national legal regulations.
- Only wash the vehicle at washing bays intended for this purpose.



Note

- Remove fresh stains such as those from ball-point pens, ink, lipstick, shoe polish, etc., from the material (leather), panels and textiles as quickly as possible.
- Due to possible issues with the cleaning and care of the interior of your vehicle, the special tools and knowledge required, we recommend that this is completed by a ŠKODA Service Partner.

Washing the vehicle



First read and observe the introductory information and safety warnings  on page 148.

The best protection for your vehicle against harmful environmental influences is **frequent** washing and wax treatment. How often the vehicle should be washed depends on a wide range of factors, such as:

- Frequency of use;
- The parking situation (garage, below trees etc.);
- Season of the year;
- Weather conditions;
- Environmental influences.

The longer insect residues, bird droppings, tree sap, road and industrial dust, tar, soot particles, road salt and other aggressive deposits remain adhering to the paintwork of your vehicle, the more detrimental their destructive effect can be. High temperatures, such as those caused by intensive sun's rays, accentuate this caustic effect.

It is essential to also thoroughly clean the **underside of the vehicle** at the end of the winter.

Automatic car wash systems



First read and observe the introductory information and safety warnings  on page 148.

Your vehicle can be washed in automatic car wash systems.

The usual precautionary measures must be taken before washing the vehicle in an automatic car wash system (closing the windows including the sliding/tilting roof, etc.).

If your vehicle is fitted with any particular attached parts, such as a spoiler, roof luggage rack, two-way radio aerial - it is best to consult the operator of the car wash system beforehand.

It is important to degrease the lips of the windscreen wiper rubbers after passing through the automatic vehicle wash system.

Washing by hand



First read and observe the introductory information and safety warnings  on page 148.

When washing by hand, first soften the dirt with plenty of water and rinse off as much as possible.

Clean the vehicle with a soft **sponge**, a **washing glove** or a **washing brush**. Work from the top to the bottom - starting with the roof. Only apply slight pressure when cleaning the vehicle's paintwork. Only use a **car shampoo** for stubborn dirt.

Wash out the sponge or washing glove thoroughly at short intervals.

Clean wheels, door sills and similar parts last. Use a second sponge for such areas.

Give the vehicle a good rinse after washing it and dry it off using a chamois leather.

Washing with a high-pressure cleaner



First read and observe the introductory information and safety warnings  on page 148.

When washing the vehicle with a high-pressure cleaner, the instructions for use of the equipment must be observed. This applies in particular to the **pressure** used and to the **spraying distance**. Maintain a sufficiently large distance to the parking aid sensors and soft materials such as rubber hoses or insulation material.



WARNING

Never use circular spray nozzles or dirt cutters!

CAUTION

The temperature of the water used for cleaning must not exceed 60 °C - risk of damaging the vehicle.

Preserving and polishing the vehicle paintwork

 First read and observe the introductory information and safety warnings  on page 148.

Preserving the vehicle paintwork

Good wax treatment is an effective way of protecting the paintwork from harmful environmental influences.

The vehicle must be treated with a high-quality hard wax polish at the latest, when no more drops form on the clean paintwork.

A new layer of a high-quality hard wax polish can be applied to the clean bodywork after it has dried thoroughly. Even if you use a wax preserver regularly we still recommend that you treat the paintwork of the vehicle at least twice a year with hard wax.

Polishing



Polishing is necessary if the vehicle's paintwork has become unattractive and if it is no longer possible to achieve a gloss with wax preservatives.

If the polish does not contain any preserving elements, the paint must be treated with a preservative afterwards.

CAUTION

- Never apply wax to the windows.
- Mat painted or plastic parts must not be treated with polishing products or hard waxes.
- Do not polish the paintwork of the vehicle in a dusty environment, otherwise the paintwork can be scratched.

Chrome parts

 First read and observe the introductory information and safety warnings  on page 148.

First clean the chrome parts with a damp cloth and then polish them with a soft, dry cloth. If this method does not completely clean chrome parts, use a specific chrome care product.

CAUTION

Do not polish the chrome parts in a dusty environment, otherwise they can be scratched.

Paint damage

 First read and observe the introductory information and safety warnings  on page 148.



Slight damage to paintwork such as scratches, scuffs or traces of chip damage must be treated immediately.

The ŠKODA Service Partners have a range of matching **touch-up pens** or **spray cans** available in the colour of your vehicle.

Note

We recommend that any repairs to damaged paintwork are carried out by a ŠKODA Service Partner.

Plastic parts

 First read and observe the introductory information and safety warnings  on page 148.

Plastic parts can be cleaned using a damp cloth. If this does not prove to be adequate, the parts can be treated with **special solvent-free plastic cleaning products**.

Paint care products are not suitable for plastic parts.

De-icing windows and exterior mirrors



First read and observe the introductory information and safety warnings  on page 148.

Use a plastic ice scraper for removing snow and ice from the windows and mirrors. The ice scraper should not be moved forward and backward but in one direction to avoid any damage to the surface of the glass.

Clean the windows from the inside on a regular basis.

Dry the glass surfaces with a clean chamois leather or a cloth intended for this purpose.

When drying the windows after washing the vehicle, do not use window leathers that have been used to polish the bodywork. Residues of preservatives in the window leather can dirty the window and reduce visibility.

CAUTION

- Never remove snow or ice from glass parts using warm or hot water - risk of formation of cracks in the glass!
- When removing snow or ice from windows and mirror lenses ensure that the paintwork of the vehicle is not damaged.
- Snow or ice that is contaminated with coarse dirt such as fine gravel, sand, and salt must not be removed from the window glass and mirrors - risk of damage to the surface of the windows and mirrors.

Radio reception and aerial



First read and observe the introductory information and safety warnings  on page 148.

Car parks, tunnels, tall buildings or mountains can disrupt the radio signal even causing it to fail completely.

With factory-fitted radios and navigation systems, the aerial for the radio reception can be installed at different locations in the vehicle:

- > on the inside of the rear window along with the rear window heater;
- > on the inside of the rear side windows;
- > on the inside of the windscreen;
- > on the roof.

Headlight lenses



First read and observe the introductory information and safety warnings  on page 148.

Use soap and clean water to clean the plastic headlight lenses.

CAUTION

- Never wipe the headlights dry and do not use any sharp objects to clean the plastic lenses, this may damage the protective paintwork and consequently cause the formation of cracks on the headlight lenses.
- Do not use any aggressive cleaning or chemical solvent products to clean the headlights - risk of damaging the headlight lenses.

Rubber seals



First read and observe the introductory information and safety warnings  on page 148.

The rubber seals on doors, the sliding roof and other windows remain smoother and last longer if the seals are treated regularly with a suitable rubber care product. This helps to prevent leakages and premature wear of the seals. Rubber seals which are well cared for also do not stick together in cold winter weather.

Door lock cylinders



First read and observe the introductory information and safety warnings  on page 148.

Specific products must be used for de-icing door lock cylinders.

Note

- When washing your vehicle, ensure as little water as possible gets into the locking cylinders.
- We recommend that suitable materials from ŠKODA Original Accessories are used for maintaining the door lock cylinders.

Wheels



First read and observe the introductory information and safety warnings  on page 148.

Wheel rims

Also thoroughly wash the wheel rims when washing the vehicle on a regular basis. Regularly remove salt and brake abrasion from the wheel rims otherwise the material will be affected. Damage to the paint layer on the wheel rims must be touched up immediately.

Light alloy wheels

After washing thoroughly and treat the wheel rims with a protective product for light alloy wheels. Products which cause abrasion must not be used to treat the wheel rims.



WARNING

Water, ice and grit in the brake system can affect the braking efficiency - risk of accident!



CAUTION

Severe layers of dirt on the wheels can also result in wheel imbalance. This may show itself in the form of a wheel vibration which is transmitted to the steering wheel which, in certain circumstances, can cause premature wear of the steering. This means it is necessary to remove the dirt.



Note

We recommend that any repairs to damaged paintwork are carried out by a ŠKODA Service Partner.

Underbody protection



First read and observe the introductory information and safety warnings  on page 148.

The underside of your vehicle is protected for life against chemical and mechanical influences.

As damage to the **protective layer** when driving cannot be ruled out completely, we recommend that you inspect the protective layer on the underside of your vehicle and on the chassis at specific intervals - preferably at the beginning and end of the winter.

ŠKODA Service Partners have suitable **spray products** and the necessary equipment available, and are familiar with the instructions for use. We therefore recommend that touch-up work or additional corrosion protection measures are carried out by a ŠKODA Service Partner.



WARNING

Never use additional underbody protection or anti-corrosion agents for exhaust pipes, catalytic converters, diesel particle filters or heat shields. When the engine reaches its operating temperature, these substances might ignite - risk of fire!

Protection of hollow spaces



First read and observe the introductory information and safety warnings  on page 148.

All the cavities of your vehicle which are at risk from corrosion are protected for life by a layer of **protective wax** applied in the factory.

This wax protection does not require to be inspected or re-treated. If any small amount of wax flow out of the cavities at high temperatures, these must be removed with a plastic scraper and the stains cleaned using a petroleum cleaner.



WARNING

Safety regulations should be observed when using petroleum cleaner to remove wax - risk of fire!

Artificial leather and materials



First read and observe the introductory information and safety warnings  on page 148.

The artificial leather can be cleaned using a damp cloth. If this does not prove to be adequate, these parts can only be treated with special **solvent-free plastic cleaning and care products**.

Clean upholstery cover materials and cloth trims on doors, boot cover, etc. using specific cleaning agents, e.g., dry foam. Use a soft sponge, brush, or commercially available microfibre cloth. Use a cloth and a specific cleaning agent to clean the roof trim.

Some clothing materials, such as dark denim, do, in part, not have sufficient colour fastness. This can cause damage or clearly visible discolouration to seat covers (fabric or leather) even when used correctly. This particularly applies to light seat covers (fabric or leather). This is not a defect in the seat cover, but poor colour fastness of the clothing textiles.

Fabric covers on electrically heated seats



First read and observe the introductory information and safety warnings  on page 148.

Do not clean the seat covers **using moisture** as this can damage the seat heating system.

Use a specific cleaning agent such as dry foam or similar to clean the covers.

Natural leather



First read and observe the introductory information and safety warnings  on page 148.

Depending on the amount of wear-and-tear, the leather should be cleaned on a regular basis.

Normal cleaning

Clean soiled areas of the leather with slightly moistened cotton or woollen cloth.

Severe soiling

Ensure that the leather is not soaked through at any point and that no water gets into the stitching of the seams.

Dry off the leather with a soft, dry cloth.

Removing stains

Remove fresh **water-based** stains (e.g., coffee, tea, juices, blood) with an absorbent cloth or household cleaning paper. A specific cleaning agent is required for dried-on stains.

Remove fresh **grease-based** stains (e.g. butter, mayonnaise, chocolate, etc.) with an absorbent cloth, household cleaning paper, or use a suitable cleaner if the stain has not yet penetrated into the surface.

Use a grease solvent for **grease stains which have dried in**.

Remove **specific stains** (e.g. ball-point pens, marker pen, nail varnish, dispersion paint, shoe polish, etc.) with a special stain remover suitable for leather.

Leather care

Treat the leather roughly every six months with a suitable leather care product.

Apply only a small amount of the cleaning and care product.

Dry off the leather with a soft, dry cloth.

CAUTION

- Avoid leaving the vehicle for lengthy periods in bright sunlight to avoid the leather from bleaching. If the vehicle is parked in the open for lengthy periods, protect the leather from direct sunlight by covering it.
- Sharp-edged objects on items of clothing such as zip fasteners, rivets, sharp-edged belts, jewellery and pendants may leave permanent scratches or signs of rubbing on the surface.
- The use of a mechanical steering wheel lock may damage the steering surface of the steering wheel.

Note

- Use a care cream with light blocker and impregnation effect on a regular basis and each time after cleaning. The cream nourishes the leather, allows it to breathe and keeps it supple and also provides moisture. It also creates surface protection.
- Clean the leather every 2 to 3 months, remove any fresh stains as they occur. ▶

- Also look after the leather dye. Refresh any areas with a special coloured leather cream as required.
- The leather is a natural material with specific properties. During the use of the vehicle, minor optical changes can occur on the leather parts of the covers (e. g wrinkles or creases as a result of the stress of the covers).

Seat belts



First read and observe the introductory information and safety warnings  on page 148.

Keep the seat belts clean!

Clean dirty seat belts using a mild soapy solution and remove coarse dirt with a soft brush!

Check the condition of all the seat belts on a regular basis.

Belt webbing which has become severely soiled may prevent the inertia reel from reeling up the belt properly.



WARNING

- The seat belts must not be removed for cleaning.
- Never clean the seat belts chemically as chemical cleaning products could destroy the fabric. The seat belts must also not be allowed to come into contact with corrosive liquids (such as acids etc.).
- Seat belts which have damage to the webbing, connections, inertia reel or lock should be replaced by a ŠKODA specialist garage.
- Inertia reel belts must be completely dried before being reeled up.

Inspecting and replenishing

Fuel

Introduction

This chapter contains information on the following subjects:

Refuelling	155
Unleaded petrol	156
Ethanol E85	157
Diesel fuel	158

The correct type of fuel for your vehicle and the tyre size and inflation pressure are specified on the inside of the fuel filler flap » Fig. 129 on page 155 - [B].

! WARNING

The national legal requirements must be observed if carrying a spare canister in the vehicle. We do not recommend carrying any fuel canisters in your vehicle for safety reasons. In the event of an accident, the canister might be damaged and fuel may leak out - risk of fire!

! CAUTION

- Never drive until the fuel tank is completely empty! The irregular supply of fuel can cause misfiring, which can result in considerable damage to parts of the engine and exhaust system.
- Immediately remove any fuel that has spilled onto the vehicle's paintwork - risk of paint damage!

Refuelling

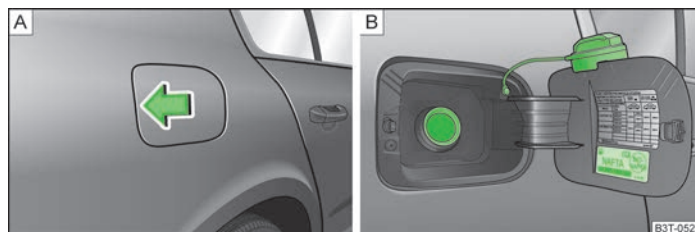

Fig. 129 Right rear side of the vehicle: Open fuel filler flap/fuel filler flap with cap unscrewed

! First read and observe the introductory information and safety warnings on page 155.

The filler flap is automatically unlocked or locked with the central locking.

Open fuel filler flap

- Press in the middle of the left area of the fuel filler flap » Fig. 129 - [A].
- Unscrew the filler cap by turning it to the left and place the cap onto the top of the fuel filler flap » Fig. 129 - [B].

Closing the filler cap

- Turn the filler cap to the right until it clicks into place.
- Close the fuel filler flap until it clicks into place.

Check that the fuel filler flap is closed properly.

! CAUTION

- Before refuelling it is necessary to switch off the auxiliary heating system (auxiliary heating and ventilation).
- The fuel tank is full just as soon as the pump nozzle switches off for the first time, provided the nozzle has been operated properly. Do not continue filling the fuel tank otherwise the expansion volume is filled up.

Note

The fuel tank has a capacity of about **55 litres** or 60 litres¹⁾, containing a reserve of approx. **7 litres**.

Unleaded petrol



First read and observe the introductory information and safety warnings  on page 155.

Your vehicle can only be operated with **unleaded fuel** that complies with the standard **EN 228** (in Germany: **standard DIN 51626-1** or **E10** for unleaded fuel with an octane rating of **95 RON** and **91 RON** or **DIN 51626-2** or **E5** for unleaded fuel with the octane rating **95 RON** and **98 RON**).

Prescribed fuel - unleaded fuel 95/91 RON

Use unleaded fuel with the octane rating **95 RON**. Unleaded petrol **91 RON** can also be used but results in a slight loss in performance.

If, in an emergency, the vehicle has to be refuelled with petrol of a lower octane number than the one prescribed, the journey must only be continued at medium engine speeds and a low engine load. Driving at high engine revs or a high engine load can severely damage the engine! Refuel using petrol of the prescribed octane number as soon as possible.

Prescribed fuel - unleaded petrol min. 95 RON

Use unleaded fuel with the octane rating **95 RON**.

In case of necessity, you can refuel with petrol with the octane rating **91 RON** if petrol with the octane rating **95 RON** is not available. The journey must only be continued at medium engine speeds and a minimum engine load. Driving at high engine revs or a high engine load can severely damage the engine! Refuel using petrol of the prescribed octane number as soon as possible.

Even in the event of an emergency, petrol of a lower octane number than **91 RON** must not be used, otherwise the engine can be severely damaged!

Unleaded petrol with higher octane number

Unleaded petrol that has a higher octane number than that required by the engine can be used without limitations.

On vehicles with prescribed unleaded petrol **95/91 RON**, the use of petrol with a higher octane number than **95 RON** does not result in a noticeable power increase or a lower fuel consumption.

On vehicles using prescribed unleaded petrol of **min. 95 RON**, the use of petrol with a higher octane number than **95 RON** can increase the power and reduce fuel consumption.

Prescribed fuel - unleaded petrol 98/(95) RON

Use unleaded fuel with the octane rating **98 RON**. Unleaded petrol **95 RON** can also be used but results in a slight loss in performance.

In case of necessity, you can refuel with petrol with the octane rating **91 RON** if unleaded fuel with octane rating **98 RON** or **95 RON** is not available. The journey must only be continued at medium engine speeds and a minimum engine load. Driving at high engine revs or a high engine load can severely damage the engine! Refuel using petrol of the prescribed octane number as soon as possible.

Even in the event of an emergency, petrol of a lower octane number than **91 RON** must not be used, otherwise the engine can be severely damaged!

Fuel additives

Only use unleaded petrol, which complies with the standard **EN 228** (in Germany: standard **DIN 51626-1** or **E10** for unleaded fuel with an octane rating of **95 RON** and **91 RON** or **DIN 51626-2** or **E5** for unleaded fuel with an octane rating of **95 RON** and **98 RON**), as these meet all of the requirements for fault-free engine operation. We therefore recommend that no fuel additives are used.

CAUTION

- All ŠKODA vehicles with petrol engines must only be operated with unleaded petrol. Just filling the tank with leaded petrol once will damage the exhaust system!
- Engine parts can be damaged if petrol with a lower octane number than the one prescribed is used.
- In no case may fuel additives with metal components be used, especially not with manganese and iron content. LRP (lead replacement petrol) fuels with metallic components may not be used. There is a risk of causing considerable damage to parts of the engine or exhaust system! ▶

¹⁾ Valid for Octavia Combi 4x4 and Octavia Scout.

- Fuels with metallic content may not be used. There is a risk of causing considerable damage to parts of the engine or exhaust system!
- The use of unsuitable fuel additives can cause considerable damage to parts of the engine or the exhaust system.

Ethanol E85

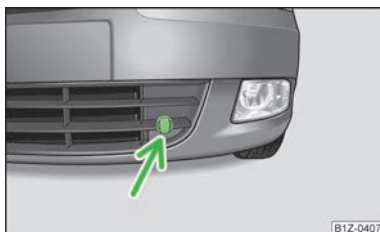

Fig. 130
MultiFuel - power socket



First read and observe the introductory information and safety warnings **!** on page 155.

Only valid for vehicles with the 1.6/75kW MultiFuel engine.

Biofuel Ethanol E85 consists of 85 % bioethanol and 15 % unleaded petrol complying with the standard (DIN) EN^o228.

Biofuel Ethanol E85 in accordance with the standard (DIN) EN 228 can be mixed in any desired ratio with unleaded petrol.

Drive the vehicle for at least 5 minutes without interruption, if biofuel Ethanol E85 has been refuelled, so that the engine control unit can determine the share of the biofuel in the fuel. During this period do not drive at top speed of your vehicle or high engine speeds and not at full throttle. During this process decrease the idling speed.

Operation in winter

If you use biofuel Ethanol E85 at very low temperatures, it is necessary to preheat the engine before an engine start.

The power socket for the engine preheating is located in the front bumper next to the fog light **» Fig. 130**.

The outside temperature	Duration of engine preheating
Below -10 °C	We recommend up to 1 hour
Below -15 °C	at least 1 hours.
Below -25 °C	at least 2 hours.

If an engine preheating is not possible at outside temperatures below -10 °C, the share of unleaded petrol complying with EN 228 must be as high as possible. Thus the cold start property of the engine is clearly improved.

If there is biofuel Ethanol E85 in the tank and the engine is not preheated, it can lead at temperatures below -15 °C to very poor or no starting of the engine.

! CAUTION

- Just filling the tank once with diesel fuel that does not comply with the standard, can cause severe damage to parts of the engine, the fuel and exhaust system!
- If you park the car for a lengthy period, fill with petrol complying with (DIN) EN^o228, because Ethanol E85 can contain low quantities of impurities, which can lead to corrosion.



For the sake of the environment

- If you use Ethanol E85, the CO₂ emission of your vehicle is lowered up to 5 %.
- The use of engine preheating at temperatures below -10 °C has a positive effect on the fuel consumption and thus on the environment.

i Note

- When operating with Ethanol E85, the fuel consumption increases by approx 33 %, as a lower quantity of energy is contained in the bioethanol than in unleaded petrol.
- Biofuel Ethanol E85 contains only a low quantity of additives in contrast to unleaded petrol. Therefore we recommend to fill up the tank with unleaded petrol complying with EN 228 every 15 000 km (e.g. before the oil change) and run it empty, so that the engine remains clean.
- The interval of 15 000 km applies for the oil change.
- An extension cable used for connecting to the electrical network is located in the luggage compartment.

Diesel fuel



First read and observe the introductory information and safety warnings  on page 155.

Your vehicle can only be operated with **diesel fuel**, which complies with the standard **EN 590** (standard **DIN 51628** in Germany, standard **ÖNORM C 1590** in Austria, **GOST R 52368-2005/EN 590:2004** in Russia).

Operation in winter - Winter-grade diesel fuel

In the winter, only use diesel fuel, which complies with the standard **EN 590** (standard **DIN 51628** in Germany, standard **ÖNORM C 1590** in Austria, **GOST R 52368-2005/EN 590:2004** in Russia). "Winter-grade diesel fuel" will still operate properly even at a temperature of -20 °C.

It is often the case in countries with different climatic conditions that diesel fuels available have a different temperature characteristic. The ŠKODA Service Partners and filling stations in the relevant country will be able to provide you with information regarding the diesel fuels available.

Preheating fuel

The vehicle is fitted with a fuel filter preheating system. This secures operation of a vehicle using diesel fuel down to an environmental temperature of -25 °C.

Fuel additives

Fuel additives, so-called "flow improvers" (petrol and similar products) must not be added to the diesel fuel.



CAUTION

- Just filling the tank once with diesel fuel that does not comply with the standard, can cause severe damage to parts of the engine, the fuel and exhaust system!
- If a different fuel other than diesel fuel, which complies to the above mentioned standards (e.g. petrol) is used by mistake do not start the engine or switch on the ignition! Extensive damage to engine parts can occur! We recommend that the fuel system is cleaned by a ŠKODA Service Partner.
- Water which has collected in the fuel filter can cause engine faults.
- Your vehicle is not adapted for use of biofuel (RME), therefore this fuel must not be refuelled and driven. The use of biofuel (RME) can cause considerable damage to parts of the engine or fuel system. ■

Engine compartment



Introduction

This chapter contains information on the following subjects:

Opening and closing the bonnet	160
Engine compartment overview	160
Checking the engine oil level	161
Replenishing the engine oil	161
Changing engine oil	162
Coolant	162
Checking the coolant level	163
Replenishing the coolant	163
Radiator fan	164
Checking the brake fluid	164
Changing the brake fluid	164
Windscreen washer system	165

There is a risk of injuries, scalding, accidents and fire when working in the engine compartment, e.g. inspecting and replenishing oil and other fluids. For this reason, it is essential to comply with the warning instructions stated below and with the general applicable rules of safety. The vehicle's engine compartment is a hazardous area.



WARNING

- Never open the bonnet if you can see steam or coolant flowing out of the engine compartment - risk of scalding! Wait until the steam or coolant has stopped escaping.
- Turn off the engine and withdraw the ignition key.
- If the vehicle is fitted with a manual gearbox, move the gearshift lever into Neutral, or if the vehicle is fitted with an automatic gearbox, move the selector lever into position **P**.
- Firmly apply the handbrake.
- Allow the engine to cool.
- For safety reasons, the bonnet must always be properly closed when driving. This is why after closing the bonnet, the lock must always be checked to ensure it has engaged properly. ▶

WARNING (Continued)

- If you notice that the lock is not properly engaged while driving, stop the vehicle immediately and close the bonnet - risk of an accident!
- Keep children clear of the engine compartment.
- Do not touch any hot engine parts - risk of burns!
- Never spill fluids on the hot engine. Such fluids (e.g. the antifreeze contained in the coolant) may ignite!
- Avoid short circuits in the electrical system - particularly on the vehicle's battery.
- Never touch the radiator fan while the engine is still warm. The fan might suddenly start running!
- Never open the end cover of the coolant expansion reservoir while the engine is still warm. The cooling system is pressurized!
- When opening the end cover of the coolant expansion reservoir, cover it with a cloth to protect your face, hands and arms from hot steam or hot coolant.
- Do not leave any items such as cloths or tools in the engine compartment.
- If you wish to work under the vehicle, you must secure the vehicle from rolling away and support it with suitable supporting blocks: the car jack is not sufficient for this - risk of injury!
- If any inspection work has to be carried out when the engine is running, there is an additional risk from rotating parts (e.g. V-belt, alternator, radiator fan) and the high-voltage ignition system. The following must also be observed:
 - Never touch the electric wiring on the ignition system.
 - Always make sure that no jewellery, loose clothing or long hair can get caught in rotating engine parts - hazard! Always remove any jewellery, tie back long hair and wear tight fitting clothing before completing any work.
- Additionally, the following warning instructions must be observed if work has to be carried out on the fuel or electrical system.
 - Always disconnect the vehicle battery from the electrical system.
 - Do not smoke.
 - Never work near open flames.
 - Always have a functioning fire extinguisher nearby.

CAUTION

- Always top up using the correct specification of fluids. This may result in major operating problems and also vehicle damage!
- Never open the bonnet using the locking lever - danger of causing damage.

For the sake of the environment

In view of the environmentally friendly disposal of fluids, the special tools and knowledge required for such work, we recommend that fluids are changed by a ŠKODA Service Partner as part of the inspection service.

Note

- If you have any questions regarding the fluids, visit a ŠKODA Service Partner.
- Fluids with the correct specifications can be purchased from ŠKODA Original Accessories. ■

Opening and closing the bonnet

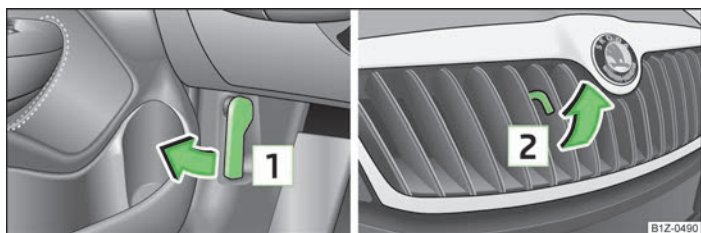

Fig. 131 Bonnet/radiator grille release lever: Release lever

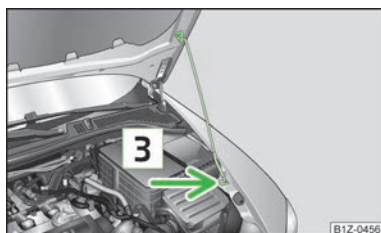

Fig. 132
Securing the bonnet with the
bonnet support

First read and observe the introductory information and safety warnings on page 158.

Opening

➤ Pull the release lever under the dash panel » Fig. 131.

Before opening the bonnet, ensure that the arms of the windscreen wipers are correctly in place against the windscreen otherwise the paintwork could be damaged.

- Pull the release lever in the direction of the arrow » Fig. 131 and the bonnet is unlocked.
- Grab hold of the bonnet and lift.
- Take the bonnet support out of its holder and secure the opened bonnet by inserting the end of the support in the opening » Fig. 132 designed for it.

Closing

- Lift the bonnet slightly and unhook the bonnet support. Press the bonnet support into the holder designed to hold it.
- Let the bonnet drop into the lock carrier lock from a height of around 20 cm - do **not** push it in.

Check that the bonnet is closed properly. ■

Engine compartment overview

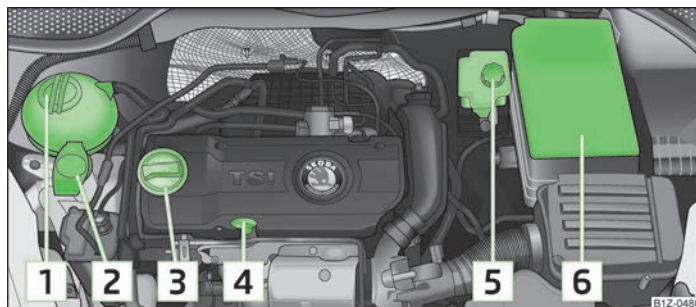

Fig. 133 1.8 ltr./118 kW TSI Petrol engine

First read and observe the introductory information and safety warnings on page 158.

	Coolant expansion reservoir _____	163
	Windscreen washer fluid reservoir _____	165
	Engine oil filler opening _____	161
	Engine oil dipstick _____	161
	Brake fluid reservoir _____	164
	Battery (below a cover) _____	165

Note

The location of the inspection points in the engine compartment of petrol and diesel engines is practically identical. ■

Checking the engine oil level

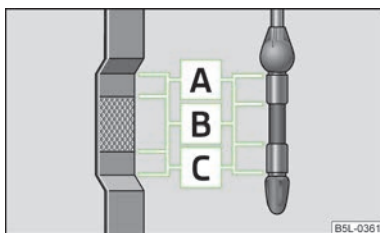

Fig. 134
Dipstick



First read and observe the introductory information and safety warnings **!** on page 158.

The dipstick indicates the level of oil in the engine » Fig. 134.

Checking the oil level

- Ensure that the vehicle is positioned on a level surface and the engine has reached its operating temperature.
- Switch off the engine.
- Open the bonnet.
- Wait a few minutes until the engine oil flows back into the oil sump and remove the dipstick.
- Wipe the dipstick with a clean cloth and insert it again to the stop.
- Then pull the dipstick out again and check the oil level.

Oil level within range **A**

- No oil must be refilled.

Oil level within range **B**

- Oil can be refilled. It is possible that the oil level may then be within range **A** after doing this.

Oil level within range **C**

- Oil **must** be refilled. It is sufficient, once this is done, to keep the oil level within range **B**.

It is normal for the engine to consume oil. The oil consumption may be as much as 0.5 l/1 000 km depending on your style of driving and the conditions under which you operate your vehicle. Consumption may be slightly higher than this during the first 5 000 kilometres.

One should therefore check the oil level at regular intervals, preferably every time after the fuel tank is filled or after driving for long stretches.

We recommend maintaining the oil level within the range **A**, **but not above**, if the engine has been operating at high loads, for example, during a lengthy motorway trip during the summer months, towing a trailer or negotiating a high mountain pass.

The warning light in the instrument cluster will indicate whether the oil level is too low » page 21, *Engine oil* . In this case, check the oil level with the dipstick, as soon as possible. Add oil accordingly.



CAUTION

- The oil level must on no account extend beyond the range **A** » Fig. 134. Risk of damaging the exhaust system!
-  **Do not continue your journey if for some reason it is not possible to top up the engine oil under the prevailing conditions! Switch off the engine** and obtain professional assistance from a ŠKODA specialist garage, otherwise it could cause severe engine damage.



Note

Engine oil specifications » page 200, *Specifications and engine oil capacity*.

Replenishing the engine oil



First read and observe the introductory information and safety warnings **!** on page 158.

- Check the engine oil level » page 161.
- Unscrew the cap of the engine oil filler opening.
- Replenish the oil in portions of 0.5 litres in accordance with the correct specifications » page 200, *Specifications and engine oil capacity*.
- Check the oil level » page 161.
- Carefully screw on the oil filler opening cap and push the dipstick in fully.

Changing engine oil



First read and observe the introductory information and safety warnings  on page 158.

The engine oil must be changed at the intervals stated in the Service schedule or according to the service interval indicator » [page 10, Service Interval Display](#).

CAUTION

Additives must not be added to the engine oil - risk of causing considerable damage to parts of the engine! Damage, which results from such product, are excluded from the warranty.

Note

If your skin has come into contact with oil, it must be washed thoroughly.

Coolant



First read and observe the introductory information and safety warnings  on page 158.

The cooling system is filled with a coolant in the factory.

The coolant consists of water with a concentration of coolant additive of 40 %. This mixture provides antifreeze protection down to -25 °C and also protects the cooling and heating system from corrosion. It also prevents the formation of scale and significantly increases the boiling point of the coolant.

The concentration of coolant must therefore not be reduced by adding water during the summer months or in countries with a warm climate. **The concentration of coolant additive in the coolant must be at least 40 %. 40 %.**

If a higher concentration of antifreeze is required for climatic reasons, the amount of coolant additive can only be increased up to 60 % (antifreeze protection down to approx. -40 °C). The antifreeze protection tails off above that concentration.

Vehicles exported to countries with a cold climate are already factory-filled with a coolant which offers antifreeze protection down to about -35 °C. In these countries the concentration of coolant additive should be at least 50 %.

When refilling, we only recommend you use the same antifreeze written on the antifreeze expansion tank » [Fig. 135](#) on page 163.

Coolant capacity

Petrol engines	Capacities (in litres)
1.2 ltr./77 kW TSI	7.7
1.4 l/59 kW	7.1
1.4 ltr./90 kW TSI	7.7
1.6 l/75 kW	7.4
1.8 ltr./112 kW TSI	8.6
1.8 ltr./118 kW TSI	8.6
2.0 ltr./147 kW TSI	8.6

Diesel engines	Capacities (in litres)
1.6 ltr./77 kW TDI CR	8.4
1.9 l/77 kW TDI PD	8.4
1.9 ltr./77 kW TD PD DPF	8.4
2.0 ltr./81 kW TDI CR	8.4
2.0 ltr./103 kW TDI CR DPF	8.4
2.0 ltr./125 kW TDI CR	8.4

CAUTION

- Other coolant additives that do not comply with the correct specifications can above all significantly reduce the anticorrosion effect.
- Any faults resulting from corrosion may cause a loss of coolant and can consequently result in major engine damage!

Note

On vehicles that are fitted with an auxiliary heater (auxiliary heating and ventilation), the coolant capacity is approx. 1 l larger.

Checking the coolant level

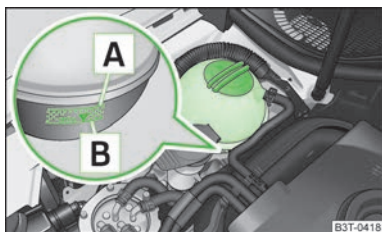





Fig. 135
Engine compartment: Coolant expansion reservoir

 First read and observe the introductory information and safety warnings  on page 158.

The coolant expansion bottle is located in the engine compartment.

- Switch off the engine.
- Open the bonnet » page 160.
- Check the level of coolant in the coolant expansion bottle » Fig. 135. The coolant level when the engine is cold must lie between the [B] (MIN) and [A] (MAX) markings. The level may also rise slightly above the [A] (MAX) marking when the engine is warm.

If the coolant level in the coolant expansion tank is too low, this is indicated by the warning light  lighting up in the instrument cluster » page 20, *Coolant temperature/coolant level* . We still recommend inspecting the coolant level directly at the reservoir from time to time.

Loss of coolant

A loss of coolant is first and foremost an **indication of a leak** in the system. Do not merely top up the coolant. Have the cooling system checked by a ŠKODA specialist garage immediately.

CAUTION

If a fault causes the engine to overheat, we recommend visiting a ŠKODA Service Partner immediately, otherwise serious engine damage may occur. ■

Replenishing the coolant

 First read and observe the introductory information and safety warnings  on page 158.

- Switch off the engine.
- Allow the engine to cool.
- Place a cloth over the cap of the coolant expansion reservoir » Fig. 135 on page 163 and unscrew the cap **carefully**.
- Replenish the coolant.
- Turn the cap until it clicks into place.

Do not use an alternative additive if the specified coolant is not available in an emergency. In this case, just use water and have the correct mixing ratio of water and the coolant additive restored by a ŠKODA specialist garage as soon as possible.

Only use new coolant to top up the system.

Do not fill the coolant above the mark [A] (max.) » Fig. 135 on page 163! Excess coolant heats up and then is forced out of the cooling system through the pressure relief valve in the cap.



WARNING

- The coolant additive and thus all of the coolant is harmful to your health. Avoid contact with the coolant. Coolant vapours are also harmful to health. Therefore always safely store the coolant additive in its original container out of the reach of children - risk of poisoning!
- If any coolant splashes into your eyes, immediately rinse out your eyes with clear water and contact a doctor as soon as possible.
- You should also consult a doctor without delay if you have inadvertently swallowed coolant.

CAUTION

Do not continue your journey, if it is not possible  to **top up the coolant under the prevailing conditions**. Contact a ŠKODA Service Partner to avoid the risk of serious engine damage. ■

Radiator fan

 First read and observe the introductory information and safety warnings  on page 158.

The radiator fan is driven by an electric motor and controlled according to the coolant temperature.

After switching off the ignition, the radiator fan can intermittently continue to operate for approx. 10 minutes.

Checking the brake fluid

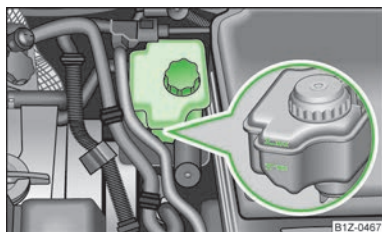





Fig. 136
Engine compartment: Brake fluid reservoir

 First read and observe the introductory information and safety warnings  on page 158.

The brake fluid reservoir is located in the engine compartment.

- > Switch off the engine.
- > Open the bonnet » page 160.
- > Check the level of brake fluid in the reservoir » Fig. 136. The level must be between the "MIN" and "MAX" markings.



When driving, a slight drop in the fluid level is caused by the wear-and-tear and automatic adjustment of the brake pads, and is therefore perfectly normal.

There may be an indication of a leak in the brake system, however, if the fluid level drops significantly within a short time or if it drops below the "MIN" marking. If the brake fluid level is too low, this is indicated by the warning light  lighting up in the instrument cluster » page 19, *Brake system* .

WARNING

If the fluid level has dropped below the MIN marking,  do not continue your journey - risk of accident! Seek help from a ŠKODA specialist garage.

Changing the brake fluid

 First read and observe the introductory information and safety warnings  on page 158.

Brake fluid absorbs moisture. Over time it therefore absorbs moisture from the environment. Excessive water in the brake fluid may be the cause of corrosion in the brake system. The water content also lowers the boiling point of the brake fluid.

The brake fluid must comply with the following standards or specifications:

- > VW 50114;
- > FMVSS 116 DOT4.

WARNING

Using old brake fluid can result in severe stress on the brakes because of the formation of vapour bubbles in the brake system. This greatly impairs the braking efficiency and thus also the safety of your vehicle.

CAUTION

Brake fluid damages the paintwork of the vehicle.

Windscreen washer system

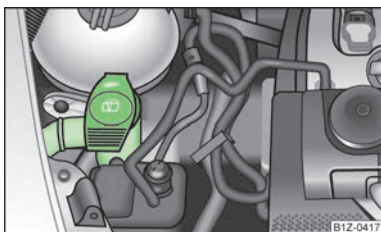



Fig. 137
Engine compartment: Wind-
screen washer fluid reservoir

 **First read and observe the introductory information and safety warnings  on page 158.**

The windscreen washer fluid reservoir contains the cleaning fluid for the windscreen or rear window and for the headlight cleaning system. The windscreen washer fluid reservoir is located in the engine compartment.

The **filling level** of the container is about 3 litres and about 5.5 litres on vehicles that have a headlight washing system¹⁾.

Clear water is not sufficient to intensively clean the windscreen and headlights. We therefore recommend using clean water with a screen cleaner (**including anti-freeze in the winter**) that is able to remove stubborn dirt.

Antifreeze should always be added to the cleaning water in the winter even if the vehicle is fitted with heated windscreen washer nozzles.

Under exceptional circumstances, methylated spirits can also be used if no screen cleaner with antifreeze is available. The concentration of methylated spirits must not be more than 15 %. The freeze protection at this concentration is sufficient only to -5 °C.

CAUTION

- Under no circumstances must radiator antifreeze or other additives be added to the windscreen washer fluid.
- If the vehicle is fitted with a headlight cleaning system, only cleaning products which do not attack the polycarbonate coating of the headlights must be added to the windscreen washer fluid.

Note

Do not remove the filter from the windscreen washer fluid reservoir when replenishing it with liquid otherwise the liquid transportation system can be contaminated, which can cause the windscreen washer system to malfunction.





Vehicle battery

Introduction

This chapter contains information on the following subjects:

Battery cover	167
Checking the battery electrolyte level	167
Operation in winter	167
Charging a vehicle battery	168
Disconnecting and reconnecting the vehicle battery	168
Replacing the vehicle battery	168
Automatic load deactivation	169

Warning symbols on the vehicle battery

Symbol	Importance
	Always wear eye protection.
	Battery acid is severely caustic. Always wear gloves and eye protection.
	Keep fire, sparks, open flames and lit cigarettes well clear of the vehicle battery.
	When charging the vehicle battery, a highly explosive gas mixture is produced.
	Keep children away from the vehicle battery.

¹⁾ In some countries, 5.5 ltr. applies for both variants.

Improper handling of the vehicle battery can cause damage. We therefore recommend that any work on the vehicle battery is carried out by a ŠKODA Service Partner.

There is a risk of injuries, scalding, accidents and burns when carrying out any work on the battery and on the electrical system. For this reason, it is essential to comply with the warning instructions stated below and with the general applicable rules of safety.

WARNING

- The battery acid is strongly corrosive and must, therefore, be handled with the greatest of care. Always wear protective gloves, eye and skin protection when handling the vehicle battery. Corrosive fumes in the air irritate the air passages and lead to conjunctivitis and inflammation of the air passages in the lungs. They corrode tooth enamel. After contact with the skin, the acid creates deep wounds which take a long time to heal. Repeated contact with diluted acids causes skin diseases (inflammations, ulcers, skin cracks). Acids coming into contact with water are diluted accompanied by significant development of heat.
- Do not tilt the battery otherwise battery electrolyte may flow out of the battery vent openings. Protect the eyes with safety glasses or a shield! There is the danger of suffering blindness! If any battery electrolyte comes into contact with your eyes, rinse the relevant eye immediately with clear water for several minutes. Then consult a doctor immediately.
- Splashes of acid on your skin or clothes should be neutralised as soon as possible using soap suds and then rinsed with plenty of water. If acid was swallowed, seek immediate medical attention.
- Keep children away from the vehicle battery.
- When you charge a battery, hydrogen is released, and a highly explosive gas mixture is also produced. An explosion can be caused through sparking over during unclamping or loosening of the cable plug while the ignition is on.
- Bridging of the poles will create a short circuit (e.g. through metal objects, cables). Possible consequences of a short circuit: Melting of lead struts, explosion and burning of the battery, jets of acid spurting out.
- It is prohibited to work with a naked flame and light, to smoke or to carry out any activities which produce sparks. Avoid creating sparks when working with cables and electrical devices. Strong sparking represents a risk of injury.

WARNING (Continued)

- Before carrying out any work on the electrical system, switch off the engine, the ignition and all of the electrical components and disconnect the negative terminal (-) on the battery. If you wish to replace a bulb it suffices to switch off the relevant light.
- Never charge a frozen or thawed vehicle battery - risk of explosion and caustic burns! Replace a frozen vehicle battery.
- Never jump-start vehicle batteries with an electrolyte level that is too low - risk of explosion and caustic burns!
- Never use a damaged vehicle battery - risk of explosion! Replace a damaged vehicle battery immediately.

CAUTION

- The vehicle battery must only be disconnected if the ignition is switched off, otherwise the vehicle's electrical system (electronic components) can be damaged. When disconnecting the battery from the electrical system, first of all disconnect the negative terminal (-) of the battery. Then disconnect the positive terminal (+).
- When connecting the battery to the electrical system, first connect the positive terminal (+) of the battery. Then connect the negative terminal (-). Under no circumstances must the battery cables be connected incorrectly - risk of a cable fire.
- Ensure that battery acid does not come into contact with the bodywork - risk of damage to the paintwork.
- Do not place the battery in direct daylight in order to protect the vehicle battery housing from the effects of ultra-violet light.
- If the vehicle has not been driven for more than 3 to 4 weeks, the battery will discharge. This is because certain electrical components consume electricity (e.g. control units) also in idle state. Prevent the battery from discharging by disconnecting the battery's negative terminal or continuously charging the battery with a very low charging current.
- If the vehicle is frequently used for making short trips, the vehicle battery will not have time to charge up sufficiently and may discharge.

For the sake of the environment

A vehicle battery that has been removed is a special type of hazardous waste. These must be disposed of in accordance with national legal regulations.

Note

You should replace batteries older than 5 years. ■

Battery cover

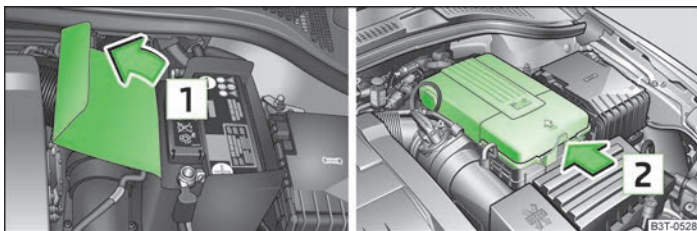

Fig. 138 Engine compartment: Polyester cover of the vehicle battery/plastic cover of the vehicle battery

First read and observe the introductory information and safety warnings on page 165.

The battery is located in the engine compartment in a polyester cover

1 » Fig. 138 or in a plastic cover 2.

» Open the battery cover in the direction of the arrow 1 or press the interlock on the side of the battery cover in the direction of the arrow 2, fold the cover up and remove.

» The battery cover is installed in reverse order.

When working on the battery, the edge of the polyester battery cover 1 is inserted between the battery and the side wall of the battery cover.

Checking the battery electrolyte level

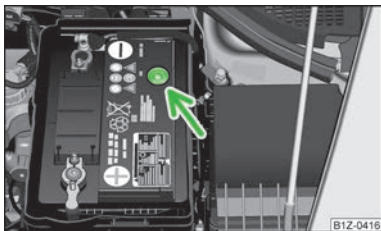

Fig. 139 Vehicle battery: Electrolyte level indicator



First read and observe the introductory information and safety warnings on page 165.

We recommend you have the electrolyte level checked by a ŠKODA specialist garage from time to time, especially in the following cases.

- » High outside temperatures.
- » Long daily drives
- » After each charge » page 168.

On vehicles with a vehicle battery fitted with a colour indicator, the so-called magic eye » Fig. 139, the electrolyte level can be determined by looking at the change in colour.

Air bubbles can influence the colour of the indicator. For this reason carefully knock on the indicator before carrying out the check.

- » Black colour - electrolyte level is correct.
- » Colourless or light yellow colour - electrolyte level too low, the battery must be replaced.



Note

- The battery electrolyte level is periodically checked by a ŠKODA Service Partner as part of the Inspection Service.
- For technical reasons, on vehicles with the description "AGM", the electrolyte level cannot be checked.
- Vehicles with a START-STOP system are fitted with a battery control unit for checking the energy level for the recurring engine start.

Operation in winter



First read and observe the introductory information and safety warnings on page 165.

At low temperatures, the vehicle battery only has part of the initial power output that it has at normal temperatures.

A discharged vehicle battery may already freeze at temperatures just below 0 °C.

We therefore recommend that you have the battery checked and, if necessary, recharged by a ŠKODA Service Partner before the start of the winter.

Charging a vehicle battery



First read and observe the introductory information and safety warnings  on page 165.

A properly charged vehicle battery is essential for reliably starting the engine.

- Switch off the ignition and all of the electrical components.
- Only for "quick-charging": Disconnect both battery cables (first of all "negative", then "positive").
- Attach the terminal clamps of the charger to the battery terminals (red = "positive", black = "negative").
- Only now plug the mains cable of the charger into the power socket and switch on the device.
- When charging is completed: Switch off the charger and remove the mains cable from the power socket.
- Only then disconnect the charger's terminal clamps.
- Reconnect the cables to the battery, if necessary (first of all "positive", then "negative").

It is not normally necessary to disconnect the cables of the battery if you recharge the vehicle battery using low amperages (as for example from a **mini-charger**). Refer to the instructions of the charger manufacturer.

A charging current of 0.1 multiple of the total vehicle battery capacity (or lower) must be used until full charging is achieved.

It is, however, necessary to disconnect both cables before charging the battery with high amperages, so-called "quick-charging".

"Quick-charging" the vehicle battery is **dangerous** and requires a special charger and specialist knowledge. We therefore recommend having the quick charging of vehicle batteries undertaken by a ŠKODA specialist garage.

The vent plugs of the vehicle battery should not be opened for charging.

CAUTION

On vehicles with the START/STOP system, the pole terminal of the charger must not be connected directly to the negative terminal of the vehicle battery, but only to the engine earth » [page 186](#), *Jump-starting in vehicles with the START-STOP system*.

Disconnecting and reconnecting the vehicle battery



First read and observe the introductory information and safety warnings  on page 165.

On disconnecting and reconnecting the vehicle battery the following functions are initially deactivated or are no longer able to operate fault-free.

Operation	Operating measure
Electrical power window (operational faults)	» page 37
Enter the radio/navigation system code number	» <i>User manual of the radio or » user manual of the navigation system</i>
Setting the clock	» page 11
Data in the multifunction display are deleted.	» page 12



Note

We recommend having the vehicle checked by a ŠKODA Service Partner to ensure the full functionality of all electrical systems.

Replacing the vehicle battery



First read and observe the introductory information and safety warnings  on page 165.

When replacing a battery, the new vehicle battery must have the same capacity, voltage, amperage and be the same size. Suitable types of vehicle batteries can be purchased from a ŠKODA Service Partner.

We recommend that the battery is replaced by a ŠKODA Service Partner, where the new vehicle battery will be installed properly and the original battery will be disposed of in accordance with national regulations.

Automatic load deactivation



First read and observe the introductory information and safety warnings  on page 165.

An intelligent vehicle power management system automatically takes various measures at high loads on the vehicle battery to prevent discharging of the battery: This manifests itself by the following:

- The idling speed is raised to allow the generator to deliver more electricity to the electrical system.
- Where appropriate large consumers of power, e.g. seat heaters, rear window heaters, voltage supply to the 12V power socket, have their power limited or in case of emergency shut off completely.



Note

Despite such intervention by the vehicle electric system management, the vehicle battery may be drained. For example, when the ignition is switched on a long time with the engine turned off or the side or parking lights are turned on during longer parking. Driving comfort is not put at risk by any shutting off of consumers. Often the driver is not aware of it having taken place. ■

Wheels and Tyres

Tyres

Introduction

This chapter contains information on the following subjects:

Service life of tyres _____	171
Handling wheels and tyres _____	172
New wheels and tyres _____	172
Unidirectional tyres _____	173
Spare wheel _____	173
Full wheel trim _____	174
Wheel bolts _____	174
Wheel trim caps _____	174
Tyre control display _____	175
Wheel bolts _____	176
Winter tyres _____	176
Snow chains _____	176

WARNING

- During the first 500 km, new tyres do not offer optimum grip and appropriate care should therefore be taken when driving - risk of accident!
- Never drive with damaged tyres - risk of accident!
- Only use those tyres or wheel rims which have been approved by ŠKODA for your model of vehicle. Failure to observe this instruction will adversely affect the road safety of your vehicle - risk of accident!
- The maximum permissible speed for your tyres must not be exceeded under any circumstances - risk of an accident resulting from tyre damage and loss of control of the vehicle.
- If the inflation pressure is too low, the tyre must perform a higher rolling resistance. At higher speeds the tyre will warm up as a result of this. This can result in tread separation and a tyre blowout.

WARNING (Continued)

- Do not, where possible, replace individual tyres but at least replace them on both wheels of a given axle at the same time. Always fit the tyres with the deeper tread depth to the front wheels.
- Never use tyres if you do not know anything about the condition and age.
- You must have your tyres replaced with new ones at the latest when the wear indicators have been worn down.
- Worn tyres do not provide the necessary adhesion to the road surface at high speeds on wet roads. One could experience "aquaplaning" (uncontrolled movements of the vehicle - "swimming" on a wet road surface).
- Immediately replace damaged wheel rims or tyres.
- Do not use summer or winter tyres that are older than 6 years or 4 years respectively.
- The wheel bolts must be clean and must turn easily. However, they must never be treated with grease or oil.
- If the wheel bolts are tightened to a too low tightening torque, the rim can come loose when the car is moving - risk of accident! A tightening torque which is too high can damage the bolts and threads and this can result in permanent deformation of the contact surfaces on the rim.
- In case of incorrect treatment of the wheel bolts, the wheel can loosen when the car is moving - risk of accident!
- Observe the national legal regulations relating to the use of tyres and snow chains.

CAUTION

- If a spare wheel is used that is not identical to the fitted tyres, the following must be observed » [page 173](#), *Spare wheel*.
- The prescribed tightening torque of the wheel bolts for steel and light alloy wheels is 120 Nm.
- Protect the tyres from contact with oil, grease and fuel.
- Replace any lost valve caps immediately.

For the sake of the environment

Tyres which are insufficiently inflated increase your fuel consumption. ▶

i Note

- We recommend that any work on the wheels or tyres is carried out by a ŠKODA Service Partner.
- We recommend that you use wheel rims, tyres, full wheel trims and snow chains from ŠKODA Original Accessories.

Service life of tyres

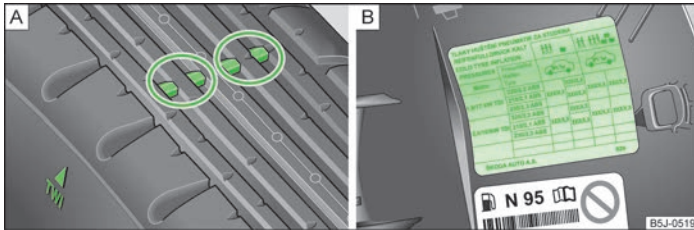

Fig. 140 Tyre tread with wear indicators/Open fuel filler flap with a table detailing the tyre size and tyre inflation pressure



First read and observe the introductory information and safety warnings **i** on page 170.

Wear indicators

The base of the tread of the tyres has 1.6 mm high wear indicators installed. These wear indicators are located multiple times depending on the make and are evenly spaced around the circumference of the tyre » Fig. 140 - [A]. Markings on the walls of the tyres through the letters "TWI", triangular symbols or other symbols identify the position of the wear indicators.

The life of your tyres very much depends on the following points:

Tyre pressure

The working life of tyres will be shortened considerably if the tyres are insufficiently or over-inflated and this will have an adverse effect on the handling of your vehicle. Therefore check the tyre pressure, including that of the spare wheel, at least once a month and also before setting off on a long journey.

The tyre inflation pressures for **summer tyres** are indicated on the inside of the fuel filler flap » Fig. 140 - [B]. The inflation pressures for **winter tyres** are 20 kPa (0.2 bar) higher than those for summer tyres.

The tyre inflation pressure for tyres of the tyre size 205/50 R17 that are designed to be used with snow chains, is identical to the tyre inflation pressure for tyres of the tyre size 225/45 R17.

The tyre pressure should be at the highest pressure specified for your vehicle at all times. The tyre inflation pressure of the spare wheel R 18 is 420 kPa.

Always check the inflation pressure when the tyres are cold. Do not reduce the higher pressure of warm tyres. If the load varies greatly, adjust the tyre inflation pressure accordingly.

Driving style

Fast cornering, sharp acceleration and braking increase the wear of your tyres.

Balancing wheels

The wheels of a new vehicle are balanced. There are a wide range of influences when driving which may result in an imbalance and which makes themselves felt through vibration in the steering.

Have the wheels rebalanced after replacing the tyres.

Wheel alignment errors

Incorrect wheel alignment at the front and rear will not only increase wear-and-tear on the tyres but will also has an adverse effect on vehicle safety. In the event of any unusual tyre wear, seek assistance from a ŠKODA specialist garage.

Tyre damage

Drive over curbs on the side of the road and other such obstacles slowly and, where possible, at a right angle in order to avoid damage to tyres and wheel trims.

We recommend checking your tyres and wheel rims for damage (punctures, cuts, splits and bulges, etc.) on a regular basis. Remove foreign bodies from the tyre profile.

Unusual vibrations or pulling of the vehicle to one side could be a sign of tyre damage. **If there is any doubt that a wheel is damaged, immediately reduce your speed and stop!** Check the tyres for signs of damage (bulges, splits, etc.). If no external damage is evident, drive slowly and carefully to the nearest ŠKODA specialist garage to have the vehicle checked.

Handling wheels and tyres

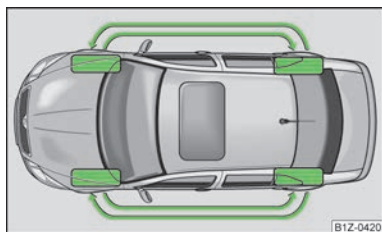



Fig. 141
Changing wheels around

 First read and observe the introductory information and safety warnings  on page 170.

Changing wheels around

If significantly greater wear is present on the front tyres, we recommend changing the front wheels around with the rear wheels as shown in the diagram » Fig. 141. You will then obtain approximately the same life for all the tyres.



We recommend that you change the wheels around every 10 000 km in order to achieve even wear on all wheels and to obtain optimal tyre life.

Storing tyres

Mark wheels before removing them so that their previous direction of running can be maintained when mounted them again.

Always store wheels or tyres which been removed in a cool, dry and, where possible, dark place. Tyres which are not fixed to a wheel trim should be stored upright.

New wheels and tyres

 First read and observe the introductory information and safety warnings  on page 170.

Only fit tyres of the same type, size (rolling circumference) and the same tread pattern on one axle on all 4 wheels.

The tyre/wheel combinations which are approved for your vehicle are indicated in your vehicle documents.

Proper knowledge of the tyre data makes it easier for you to select the correct type of tyre. Tyres, for example, have the following inscription on their walls.

195/65 R 15 91 T

What this means is:

195	Tyre width in mm
65	Height/width ratio in %
R	Code letter for the type of tyre - Radial
15	Diameter of wheel in inches
91	Load index
T	Speed symbol

The following **speed restrictions** apply to tyres.

Speed symbol	Permissible maximum speed
S	180 km/h
T	190 km/h
U	200 km/h
H	210 km/h
V	240 km/h
W	270 km/h
Y	300 km/h

The **date of manufacture** is also stated on the tyre wall (possibly only on the *inside of wheel*): e.g.

DOT ... 20 12...

means, for example, that the tyre was manufactured in the 20th week of 2012.

The following must be observed if only one temporary spare wheel is available » [page 173](#).

Unidirectional tyres



First read and observe the introductory information and safety warnings  on page 170.

The direction of rotation of the tyres is marked by **arrows on the wall of the tyre**. The so specified running direction must absolutely be complied with. Only then are the tyres able to provide the optimal properties in terms of grip, low noise, wear-and-tear and aquaplaning.

If, in the event of a puncture, it is necessary to fit a spare wheel with a tyre without a dedicated running direction or the opposite running direction, drive carefully as the optimum characteristics of the tyre are no longer applicable in this situation.

Spare wheel

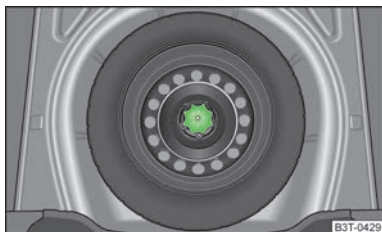



Fig. 142
Boot: Spare wheel



First read and observe the introductory information and safety warnings  on page 170.

The spare wheel is located in a well under the floor covering in the boot and is fixed in place with a special bolt [» Fig. 142](#).

Before removing the spare wheel, the box containing the vehicle tool kit must be removed.

It is important to check the inflation pressure in the spare wheel (preferably every time the tyre air pressure is checked - see sticker on the fuel filler flap [» page 171](#)) to ensure it is always ready to use.

If the dimensions or design of the spare wheel differ from the tyres fitted to the vehicle (e.g. winter tyres or low-profile tyres), it must only be used briefly in the event of a puncture and if an appropriately cautious style of driving is adopted [» !\[\]\(0d7ca0919e6c47bbd874bfa0189fe22e_img.jpg\)](#).

Replace it with a wheel having the appropriate mode and dimensions as soon as possible

Temporary spare wheel

A warning label is displayed on the wheel rim of the spare wheel to indicate that your vehicle is equipped with a temporary spare wheel.

Please observe the following when driving with a temporary spare wheel.

- The warning label must not be covered after installing the wheel.
- Do not drive faster than 80 km/h with the temporary spare wheel and pay particular attention while driving. Avoid accelerating at full throttle, sharp braking and fast cornering.
- The inflation pressure for this spare wheel is identical to the maximum inflation pressure of the standard tyres. The temporary spare wheel R 18 must have an inflation pressure of 420 kPa!
- Only use this temporary spare wheel to reach the nearest ŠKODA specialist garage as it is not intended for continuous use.
- No other summer or winter tyres must be mounted on the rim of the temporary spare wheel R 18.



WARNING

- Never use the temporary spare wheel if it is damaged.
- If the dimensions or design of the temporary spare wheel differ from the fitted tyres, never drive faster than 80 km/h (or 50 mph). Avoid accelerating at full throttle, sharp braking and fast cornering.



CAUTION

Observe the instructions on the sticker on the temporary spare wheel.



Note

The tyre pressure should be at the highest pressure specified for your vehicle at all times.

Full wheel trim

 First read and observe the introductory information and safety warnings  on page 170.

Pulling off

- Hook the clamp found in the vehicle tool kit into the reinforced edge of the wheel trim.
- Push the wheel wrench through the clamp, support on the tyre and pull off the wheel trim.

Install

- First press the full wheel trim onto the wheel rim at the valve opening provided. Then press the full wheel trim into the wheel rim until its entire circumference locks correctly in place.

CAUTION

- Use the pressure of your hand, do not knock the full wheel trim! Heavy knocks mainly on the points where the full wheel trim has not been inserted into the wheel, can result in damage to the guide and centring elements of the full wheel trim.
- First of all check that the theft-deterrent wheel bolt is located in the hole near the valve before fitting the full wheel trim onto a steel wheel which is attached with a theft-deterrent wheel bolt » [page 182, Securing wheels against theft](#).
- If **wheel trims** are retrofitted it must be ensured that an adequate flow of air is assured to cool the brake system.

Wheel bolts



Fig. 143
Remove the cap



First read and observe the introductory information and safety warnings  on page 170.

Pulling off

- Push the plastic clip sufficiently far onto the cap until the inner catches of the clip are positioned at the collar of the cap and detach the cap » [Fig. 143](#).

Install

- Push the caps onto the wheel bolts up to the stop.

The wheel bolt caps are housed in a plastic box in the spare wheel or in the storage space for the spare wheel.

Wheel trim caps

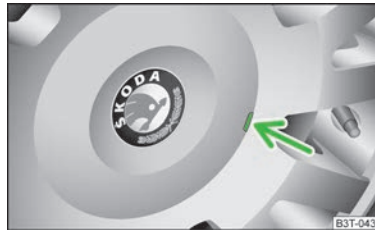



Fig. 144
Pull off the wheel trim cap on light alloy wheels



First read and observe the introductory information and safety warnings  on page 170.

Pulling off

- Carefully remove the wheel trim cap using the wire clamp from the vehicle tool kit » [Fig. 144](#).

Tyre control display



Fig. 145
Button for setting the tyre inflation pressure control value



First read and observe the introductory information and safety warnings **!** on page 170.

The tyre control display compares the speed and thus the rolling circumference of the individual wheels with the help of the ABS sensors. If the rolling circumference of a wheel is changed, the warning light **(U)** in the instrument cluster **»** page 24, *Tyre control display (U)* and an audible signal sounds.

The rolling circumference of the tyre can change if:

- the tyre inflation pressure is too low;
- the structure of the tyre is damaged;
- the vehicle is loaded on one side;
- the wheels of an axle are loaded heavily (e.g. when towing a trailer or when driving uphill or downhill);
- snow chains are mounted;
- the temporary spare wheel is mounted;
- one wheel per axle was changed.

Basic setting of the system

After changing the tyre inflation pressure, after changing one or several wheels, the position of a wheel on the vehicle (e.g. exchanging the wheels between the axles) or when the warning light lights up while driving, a basic setting of the system must be carried out as follows:

- Inflate all of the tyres to the specified inflation pressure **»** page 171, *Service life of tyres*.
- Switch on the ignition.

- Press and hold the button **(SET (U))** **»** Fig. 145 for longer than 2 seconds. While pressing the button, the warning light **(U)** illuminates. At the same time the system memory is erased and the new calibration is started, which is confirmed with an audible signal and then the warning light **(U)** goes out.
- If the warning light **(U)** does not go out after the basic setting, this indicates a system fault. Seek help from a ŠKODA specialist garage.

The warning light **(U)** is lit

If the tyre inflation pressure of at least one wheel is insufficiently inflated in comparison to the stored basic value, the warning light **(U)** **»** **!** lights up.

The warning light **(U)** flashes

If the warning light flashes, there is a system fault. Seek help from a ŠKODA specialist garage to correct the fault.



WARNING

- When the warning light **(U)** illuminates, immediately reduce the speed and avoid sudden steering and brake manoeuvres. Stop the vehicle as soon as possible and inspect the tyres and their inflation pressure.
- Under certain circumstances (e.g. sporty style of driving, wintry or unpaved roads) the warning light **(U)** can be delayed or does not light up at all.
- The tyre control display does not absolve the driver of the responsibility to ensure the correct tyre inflation pressure. For this reason, the tyre inflation pressure must be checked regularly.



Note

- The tyre control display does therefore not replace the regular tyre inflation pressure control, as the system cannot detect an even loss of pressure.
- The tyre control display cannot provide a warning in the event of very rapid tyre inflation pressure loss, e.g. in the case of sudden tyre damage. In this case carefully bring the vehicle to a standstill without sudden steering movements or sharp braking.
- To ensure a proper functioning of the tyre control display, it is necessary to repeat the basic setting every 10 000 km or once a year.

Wheel bolts



First read and observe the introductory information and safety warnings  on page 170.

Wheels and **wheel bolts** are matched to each other in terms of design. Each time you fit other wheels, e.g. light alloy wheels or wheels with winter tyres, you must therefore also use the matching wheel bolts of the correct length and shape of spherical cap. This is essential to ensure that the wheels are tightly fitted and that the brake system operates properly. ■

Winter tyres



First read and observe the introductory information and safety warnings  on page 170.

The handling of your vehicle will be significantly improved when driving on wintry roads if you fit winter tyres. Summer tyres do not offer the same grip on ice, snow and at temperatures below 7 °C because of their construction (width, rubber blend, tread pattern). This particularly applies to vehicles which are equipped with **low-profile tyres** or **high-speed tyres** (code index H or V on wall of tyre).

To achieve the best possible handling properties, winter tyres must be fitted on all 4 wheels, the minimum tread depth must be 4 mm and tyres must be no older than 4 years.

Winter tyres of a lower speed category can be used provided that the permissible maximum speed of these tyres is not exceeded even if the possible maximum speed of the vehicle is higher.



For the sake of the environment

Fit the summer tyres on again in good time as they provide better handling properties, a shorter braking distance, less tyre noise, and reduced tyre wear on roads which are free of snow and ice as well as at temperatures above 7 °C. The fuel consumption is also lower. ■

Snow chains



First read and observe the introductory information and safety warnings  on page 170.

Snow chains must only be mounted on the front wheels.

When driving on wintry roads, snow chains improve not only traction, but also the braking performance.

For technical reasons, it is only permissible to fit snow chains with the following wheel/tyre combinations.

Wheel size	Depth (D)	Tyre size
6J x 15 ^{a)}	47 mm	195/65
6.5J x 15 ^{a)}	50 mm	195/65
6J x 16 ^{a)}	50 mm	205/55
6J x 17 ^{b)}	45 mm	205/50

^{a)} Only fit snow chains with links and locks not larger than 15 mm.

^{b)} Only fit snow chains with links and locks not larger than 9 mm.

Remove the **full wheel trims** before installing the snow chains.

Observe the national legal regulations relating to the use of snow chains and the maximum vehicle speed with snow chains.

CAUTION

The chains must be removed when driving on roads which are free of snow. They adversely affect the handling of your vehicle, damage the tyres and are rapidly destroyed. ■

Accessories, changes and replacement of parts

Introductory information

If you want to retrofit the vehicle with accessories, if a vehicle part is to be replaced with a new one, or when needing to make technical changes, the following instructions must be observed.

- Always seek advice from a ŠKODA Service Partner **before** purchasing any accessories or parts and **before** making any technical changes » .
- The guidelines and instructions issued by ŠKODA must be observed when making technical changes.

Adhering to the prescribed procedures will prevent any kind of damage to the vehicle, and its travelling and operating safety will be maintained. The vehicle also complies with German road transport regulations (StVZO). More information is available from a ŠKODA Service Partner who can also perform the necessary work correctly.

Vehicles with special built-on types

Technical documents regarding changes carried out on the vehicle must be kept by the vehicle user, in order to hand over later to the old car user. This ensures the recycling in accordance with environmental regulations.

Interference on the electronic components and their software can lead to operational faults. This interference can also impair not directly affected systems because of the networking of the electronic components. In other words, the vehicle's roadworthiness may be put at risk and increased wear on parts may arise.

Any damage caused by technical changes made without consent by ŠKODA is excluded from the warranty – see the warranty certificate.

WARNING

- Work or modifications on your vehicle, which have been carried out unprofessionally, can cause operational faults - risk of accident!
- We advise you, in your own interest, to only use ŠKODA Original Accessories and ŠKODA Original Parts which have been expressly approved for use on your vehicle. Reliability, safety and suitability have been established for ŠKODA Original Accessories and ŠKODA Original Parts.
- Although we constantly monitor the market, we are not able to assess or warrant the parts even though in some instances such parts may have a type approval or may have been approved by a nationally recognised testing laboratory.

Note

ŠKODA Original Accessories and ŠKODA Original Parts can be purchased from ŠKODA Service Partners who will also professionally undertake the assembly of the purchased parts.

Changes and impairments of the airbag system

Repairs and technical modifications must comply with ŠKODA guidelines.

We recommend that any modifications and repairs to the front bumper, doors, front seats, headliner or bodywork be carried out by a ŠKODA Service Partner. These vehicle parts may include system components for the airbag system.

WARNING

- Airbag modules can not be repaired, but must be replaced.
- Never install any airbag parts into the vehicle that have been removed from old cars or have been recycled.
- A modification to the suspension of the vehicle including the use of non-approved rim-tyre combinations can alter the functioning of the airbag and increase the risk of serious or fatal injuries in an accident.
- Parts of the airbag system may be damaged when working on the airbag system or removing and installing system parts due to other repairs. This may mean that the airbags will not deploy properly or not at all in the event of an accident.

Do-it-yourself

Do-it-yourself

First-aid kit and warning triangle

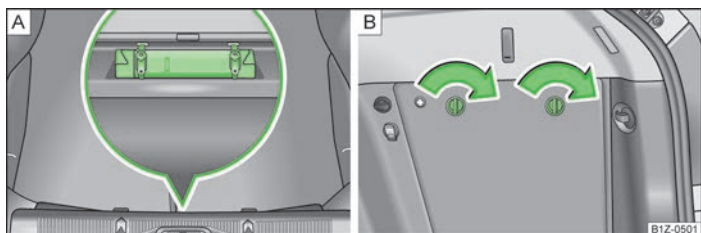

Fig. 146 Placing of the warning triangle

First-aid box and warning triangle

The first-aid box is attached by a strap to the right-hand side of the luggage compartment.

The warning triangle can be attached to the rear wall trim panel with rubber straps » Fig. 146 - [A].

First-aid box and warning triangle (Estate car)

In estate cars, the first-aid box and warning triangle are housed in the right-hand side compartment in the luggage compartment. The compartment is opened by turning the locks in the direction of the arrow » Fig. 146 - [B].

! WARNING

The first-aid kit and warning triangle must always be secured safely so that they do not come loose when making an emergency braking or in a vehicle collision which could cause injuries to occupants.

i Note

- Pay attention to the expiration date of the first-aid kit.
- We recommend using a first-aid box from ŠKODA Original Accessories available from a ŠKODA Service Partner.

Fire extinguisher

The fire extinguisher is attached with straps in a holder under the driver seat.

On vehicles fitted with electrically adjustable seats, the fire extinguisher is fastened to a bracket underneath the front passenger seat.

Please read carefully the instructions which are attached to the fire extinguisher.

The fire extinguisher must be checked by an authorised person on an annual basis (the national legal provisions must be observed).

! WARNING

The fire extinguisher must always be secured safely so that they do not come loose when making an emergency braking or in a vehicle collision which could cause injuries to occupants.

i Note

- The fire extinguisher must comply with the relevant applicable national legal requirements.
- Pay attention to the expiration date of the fire extinguisher. If the fire extinguisher is used after the expiration date, its proper function is no longer assured.
- The fire extinguisher is part of the scope of delivery in certain countries only.

Vehicle tool kit



Fig. 147
Boot: Storage compartment for vehicle tool kit

The vehicle tool kit and the lifting jack with sticker are housed in a plastic box in the spare wheel » Fig. 147 or in the storage space for the spare wheel. There is also space here for the removable ball rod for the trailer towing device. The box is attached with a strap on the spare wheel.

The vehicle tool kit contains the following parts (depending on equipment fitted):

- wire clamps for removing the full wheel trims;
- wheel wrench;
- towing eye;
- Adapter for anti-theft wheel bolts;
- Extraction pliers for wheel bolt caps;
- Replacement bulb set;
- Tool for removing the fog lights¹⁾.

Before placing the lifting jack back into its storage area, screw in the arm of the lifting jack fully.

! WARNING

- The factory-supplied lifting jack is only intended for your model of vehicle. Under no circumstances attempt to lift heavier vehicles or other loads - risk of injury!
- Ensure that the vehicle tool kit is safely secured in the boot.

i Note

Ensure that the box is always secured with the strap. ■

Changing a wheel

📖 Introduction

This chapter contains information on the following subjects:

Preliminary work	180
Changing a wheel	180
Subsequent steps	180
Loosening and tightening wheel bolts	181
Raising the vehicle	181
Securing wheels against theft	182

! WARNING

- If you are in flowing traffic, switch on the hazard warning light system and set up the warning triangle at the prescribed distance! The national legal requirements must be observed. In this way you are not only protecting yourself but other road users as well.
- If the wheel is damaged or in the event of a puncture, park the vehicle as far away as possible from the flow of traffic. Park on as flat and firm a surface as possible.
- If the wheel has to be changed on a slope, first of all block the opposite wheel with a stone or similar object to prevent the vehicle from unexpectedly rolling away.
- If the vehicle is subsequently fitted with tyres which are different to those it was fitted with at the works, follow these guidelines » page 172, *New wheels and tyres*.
- Always raise the vehicle with the doors closed.
- Never position any body parts, such as arms or legs under the vehicle, while the vehicle is raised with a lifting jack.
- Secure the base plate of the lifting jack with suitable means to prevent possible moving. A soft and slippery ground under the base plate may move the lifting jack, causing the vehicle to fall down. It is therefore always necessary to ▶

¹⁾ Valid for Octavia RS and Octavia Scout.

WARNING (Continued)

place the lifting jack on a solid surface or use a wide and stable base. Use a non-slip base (e.g. a rubber foot mat) if the **surface is smooth**, such as cobbled stones, tiled floor, etc.

- Never start the engine with the vehicle sitting on the raised jack - danger of suffering injury.
- Only attach the lifting jack to the attachment points provided for this purpose.

CAUTION

- The prescribed tightening torque of the wheel bolts for steel and light alloy wheels is 120 Nm.
- If the anti-theft wheel bolt is fastened too tightly, it can cause damage to the anti-theft wheel bolt and adapter.

Note

- The anti-theft wheel bolt set and adapter can be purchased from a ŠKODA Service Partner.
- The national legal requirements must be observed when changing a wheel.

Preliminary work



First read and observe the introductory information and safety warnings  on page 179.

The following steps must be carried out before actually changing the wheel:

- In the event of a puncture, park the vehicle as far away as possible from the flow of traffic. The place you choose should be **level**.
- **Let all of the occupants get out.** While changing a tyre, the occupants of the vehicle should not stand on the road (instead they should remain behind a crash barrier).
- Switch off the engine and move the gearshift lever into **Neutral** or move the **selector lever** for the automatic gearbox **into position P**.
- Firmly apply the **handbrake**.
- If a trailer is connected, remove it.
- Remove the **vehicle tool kit** » page 179 and the **spare wheel** » page 173 from the boot.

Changing a wheel



First read and observe the introductory information and safety warnings  on page 179.

Always change a wheel on a level surface as far as possible.

- Remove the full wheel trim » page 174 or caps » page 174.
- In the case of light alloy wheel rims remove the wheel trim cap » page 174.
- First of all slacken the anti-theft wheel bolt and then the other wheel bolts » page 181.
- Jack up the vehicle until the wheel that needs changing is clear of the ground » page 181.
- Unscrew the wheel bolts and place them on a clean surface (cloth, paper, etc.).
- Remove the wheel.
- Attach the spare wheel and slightly screw on the wheel bolts.
- Lower the vehicle.
- Alternately tighten the wheel bolts opposite each other using the wheel wrench (crosswise) and then tighten the anti-theft wheel bolt » page 181.
- Reinstall the wheel trim/wheel trim cap or the caps.



Note

- All bolts must be clean and must turn easily.
- Under no circumstances grease or oil the wheel bolts!
- When fitting unidirectional tyres, ensure that the direction of rotation is correct » page 170.

Subsequent steps



First read and observe the introductory information and safety warnings  on page 179.

The following steps must also be performed after changing the wheel.

- Stow and attach the replaced wheel in the spare wheel well using a special screw » page 173.
- Stow the vehicle tool kit in the space provided.
- **Check the tyre pressure** on the installed spare wheel as soon as possible.
- Have the **tightening torque** of the wheel bolts **checked** with a torque wrench as soon as possible.
- Change the damaged wheel or consult a ŠKODA specialist garage about repair possibilities.

i Note

- If it is determined that the wheel bolts are corroded and difficult to turn when changing the wheel, the bolts must be replaced before checking the tightening torque.
- Drive cautiously and only at a moderate speed until the tightening torque has been checked.

Loosening and tightening wheel bolts



Fig. 148
Changing a wheel: Loosening the wheel bolts

 First read and observe the introductory information and safety warnings **i** on page 179.

Loosening

- Push the wheel wrench onto the wheel bolt up to the stop¹⁾.
- Grasp the end of the wrench and turn the bolt about **one** turn to the left » Fig. 148.

Tightening

- Push the wheel wrench onto the wheel bolt up to the stop¹⁾.
- Grasp the end of the wrench and turn the bolt to the right until it is tight.

! WARNING

Undo the wheel bolts only a little (about one turn) as long as the vehicle has not yet been jacked up - risk of an accident!

i Note

If it proves difficult to undo the bolts, carefully apply pressure to the end of the wrench with your **foott**. Keep hold of the vehicle when doing so, and make sure you keep your footing.

Raising the vehicle

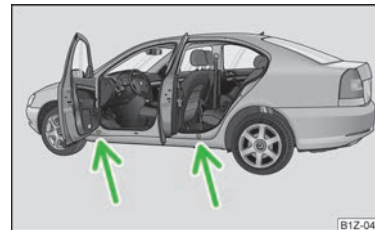

Fig. 149
Changing a wheel: Jacking points for positioning lifting jack

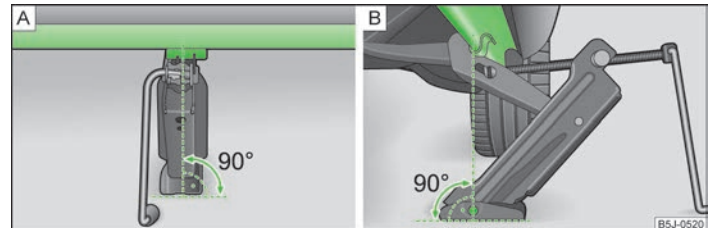



Fig. 150 Attach lifting jack

 First read and observe the introductory information and safety warnings **i** on page 179.

Position the lifting jack by selecting the jacking point that is closest to the faulty wheel » Fig. 149. The jacking point is located directly below the engraving in the lower sill. The engraving is only visible after opening the door.

¹⁾ Use the appropriate adapter for undoing and tightening the anti-theft wheel bolts » page 182.

- Position the lifting jack below the jacking point and move it up until its claw is positioned directly below the vertical web of the lower sill.
- Align the lifting jack so that its claw grasps the web » Fig. 150 - B below the embossing in the side surface of the lower sill.
- Ensure that the entire surface of the lifting jack base plate rests on level ground and is located in a vertical position to the area » Fig. 150 where the claw grasps the web.
- Continue turning up the jack until the wheel is just about lifted off the ground. ■

Securing wheels against theft

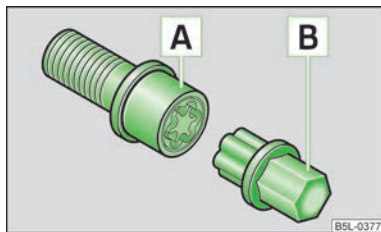

Fig. 151
Principle sketch: Anti-theft
wheel bolt with adapter

First read and observe the introductory information and safety warnings on page 179.

The anti-theft wheel bolts on vehicles fitted with them (one anti-theft wheel bolt per wheel) can only be loosened or tightened up by using the adapter provided.

- Pull off the full wheel trim from the wheel rim or the cap from the anti-theft wheel bolt.
- Insert the adapter **B** » Fig. 151 with its toothed side fully into the inner tooth- ing of the safety wheel bolt **A** until the stop so that only the outer hexagon is jutting out.
- Push the wheel wrench onto the adapter **B** up to the stop.
- Loosen or tighten the wheel bolt » page 181.
- After removing the adapter, reinstall the full wheel trim or place the cap onto the anti-theft wheel bolt.
- Have the **tightening torque checked** with a torque wrench as soon as possible.

It is advisable to make a note of the code number hammered into the rear side of the adapter or the rear side of the anti-theft wheel bolt. This number can be used to purchase a replacement adapter from a ŠKODA Service Partner, if necessary.

We recommend that you always carry the adapter for the wheel bolts with you in the vehicle. It should be stowed in the vehicle tool kit. ■

Breakdown kit

Introduction

This chapter contains information on the following subjects:

Components of the breakdown kit	183
Preparing to use the breakdown kit	184
Sealing and inflating tyres	184
Check after driving for 10 minutes	185

The breakdown kit is located in a box under the floor covering in the boot.

Use the breakdown kit to reliably repair tyre damage caused by foreign bodies or a puncture with diameters up to approx. 4 mm. Do not remove foreign bodies, e.g. screws or nails, from the tyre!

The repair can be undertaken on the vehicle immediately.

Repairs with the breakdown kit **do not in any way replace** a permanent repair of the tyre, it only serves to reach the next ŠKODA specialist garage.

The breakdown kit must not be used under the following circumstances:

- if there is damage to the wheels;
- in outside temperatures of less than -20 °C;
- with tears or punctures greater than 4 mm in size;
- if there is damage to the tyre wall;
- when driving with very low tyre pressure or with a completely flat tyre;
- if the use-by-date (see inflation bottle) has passed. ▶

! WARNING

- If you are in flowing traffic, switch on the hazard warning light system and set up the warning triangle at the prescribed distance! The national legal requirements must be observed. In this way you are not only protecting yourself but other road users as well.
- If the wheel is damaged or in the event of a puncture, park the vehicle as far away as possible from the flow of traffic. Park on as flat and firm a surface as possible.
- A tyre filled with sealant has the same driving characteristics as a standard tyre.
- Do not drive faster than 80 km/h (50 mph).
- Avoid accelerating at full throttle, sharp braking and fast cornering.
- Check the tyre inflation pressure after driving for 10 minutes!
- The sealant is hazardous to health. Remove immediately if it comes into contact with the skin.



For the sake of the environment

Used sealant or sealant whose expiry date has passed must be disposed of in accordance with environmental protection regulations.



Note

- Observe the manufacturer's usage instructions for the breakdown kit.
- A new bottle of sealant can be purchased from ŠKODA Original Accessories.
- Immediately replace the wheel that was repaired using the breakdown kit or consult a ŠKODA specialist garage about repair possibilities.

Components of the breakdown kit

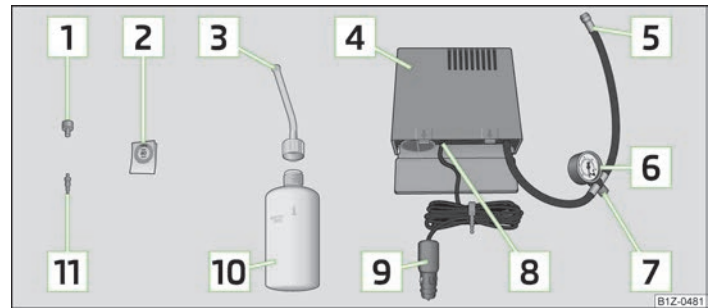

Fig. 152 Components of the breakdown kit



First read and observe the introductory information and safety warnings ! on page 182.

The breakdown kit contains the following parts:

- 1 Valve remover
- 2 Sticker with speed designation "max. 80 km/h"/"max. 50 mph"
- 3 Inflation hose with plug
- 4 Air compressor
- 5 Tyre inflation hose
- 6 Tyre inflation pressure indicator
- 7 Air release valve
- 8 ON and OFF switch
- 9 12 volt cable connector
- 10 Tyre inflator bottle with sealing agent
- 11 Replacement valve core



The valve remover 1 has a slot at its lower end which fits into the valve core. This is the only way in which you can remove and re-install the valve core from the tyre valve. The same also applies to the replacement valve core 11.

Preparing to use the breakdown kit



First read and observe the introductory information and safety warnings  on page 182.

The following preparatory work must be carried out before using the breakdown kit.







- In the event of a puncture, park the vehicle as far away as possible from the flow of traffic. Park on as flat and firm a surface as possible.
- Let **all of the occupants get out**. While changing a tyre, the occupants of the vehicle should not stand on the road (instead they should remain behind a crash barrier).
- Switch off the engine and move the gearshift lever into **Neutral** or move the **selector lever** for the automatic gearbox **into position P**.
- Firmly apply the **handbrake**.
- Check that you can carry out the repairs with the breakdown kit » [page 182](#).
- If a trailer is connected, remove it.
- Remove the **breakdown kit** from the boot.
- Stick the sticker  » [Fig. 152](#) on page 183 on the dash panel in view of the driver.
- Do not remove the foreign body, e.g. screw or nail, from the tyre.
- Unscrew the valve cap.
- Use the valve remover  to unscrew the valve core and place it on a clean surface (rag, paper, etc.).

Sealing and inflating tyres











First read and observe the introductory information and safety warnings  on page 182.

Sealing

- Forcefully shake the tyre inflator bottle  » [Fig. 152](#) on page 183 several times.
- Firmly screw the inflation hose  onto the tyre inflator bottle  in a clockwise direction. The plug on the cap is pierced automatically.
- Remove the plug from the inflation hose  and plug the open end fully onto the tyre valve.
- Hold the bottle  with the bottom facing upwards and fill all of the sealing agent from the tyre inflator bottle into the tyre.
- Remove the empty tyre inflator bottle from the valve.
- Screw the valve core back into the tyre valve using the valve remover .

Inflating

- Screw the tyre inflation hose  » [Fig. 152](#) on page 183 of the air compressor firmly onto the tyre valve.
- Check that the air release valve  is closed.
- Start the engine and run it in idle.
- Plug the connector  into 12 Volt socket » [page 69](#).
- Switch on the air compressor with the ON and OFF switch .
- Allow the air compressor to run until a pressure of 2.0 - 2.5 bar is achieved. Maximum run time of 8 minutes » .
- Switch off the air compressor.
- If you cannot reach an air pressure of 2.0 - 2.5 bar, unscrew the tyre inflation hose  from the tyre valve.
- Drive the vehicle 10 metres forwards or backwards to allow the sealing agent to “distribute” in the tyre.
- Firmly screw the tyre inflation hose  back onto the tyre valve and repeat the inflation process.
- If you cannot reach the required tyre inflation pressure here either, this means the tyre has sustained too much damage. You cannot seal with tyre with the breakdown kit » .
- Switch off the air compressor.
- Remove the tyre inflation hose  from the tyre valve.

Once a tyre inflation pressure of 2.0 – 2.5 bar is achieved, continue the journey at a maximum speed of 80 km/h (50 mph).

Check the tyre inflation pressure after driving for 10 minutes » [page 185](#).

WARNING

- During inflation, the tyre inflation hose and air compressor may get hot- risk of injury!
- Do not place the hot tyre inflation hose or hot air compressor on flammable materials - risk of fire!
- If you cannot inflate the tyre to at least 2.0 bar, this means the damage sustained was too serious. The sealing agent cannot be used to seal the tyre. Do not drive the vehicle. Get professional assistance!

CAUTION

Switch off the air compressor after running 8 minutes at the latest - danger of overheating! Allow the air compressor to cool a few minutes before switching it on again.

Check after driving for 10 minutes



First read and observe the introductory information and safety warnings  on page 182.

Check the tyre inflation pressure after driving for 10 minutes!

If the tyre inflation pressure is 1.3 bar or less:

- >  **Do not drive the vehicle!** You cannot properly seal with tyre with the breakdown kit.
- > Get professional assistance.

If the tyre inflation pressure is 1.3 bar or more:

- > Adjust the tyre inflation pressure to the correct value (see inside of fuel filler cap).
- > Continue driving carefully to the nearest ŠKODA specialist garage at a maximum speed of 80 km/h (50 mph).

Jump-starting



Introduction

This chapter contains information on the following subjects:

Jump-starting _____	186
Jump-starting in vehicles with the START-STOP system _____	186

The battery of another vehicle can be used to jump-start your vehicle if the engine will not start because the battery is flat. Jump-start cables are required for this purpose.

Both batteries must have a rated voltage of 12 V. The **capacity** (Ah) of the battery supplying the power must not be significantly less than the capacity of the discharged battery in your vehicle.

Jump-start cables

Only use jump-start cables which have an adequately large cross-section and insulated terminal clamps. Observe the manufacturer's instructions.

Positive cable - colour coding in the majority of cases is red.

Negative cable - colour coding in the majority of cases is black.



WARNING

- A discharged vehicle battery may already freeze at temperatures just below 0 °C. In case of frozen battery carry out no jump-starting - risk of explosion!
- Pay attention to the warning instructions relating to working in the engine compartment » [page 158](#), *Engine compartment*.
- The non-insulated parts of the terminal clamps must never make contact with each other. In addition, the jump-start cable connected to the positive terminal of the battery must not come into contact with electrically conducting parts of the vehicle - risk of short circuit!
- Do not clamp the jump-start cable to the negative terminal of the discharged battery. There is the risk of detonating gas seeping out the battery being ignited by the strong spark which results from the engine being started.
- Route the jump-start cables so that they cannot be caught by any rotating parts in the engine compartment.
- Do not bend over the battery - risk of caustic burns!
- The vent screws of the battery cells must be tightened firmly.
- Keep any sources of ignition (naked flame, smouldering cigarettes, etc.) away from the battery - risk of an explosion!
- Never jump-start vehicle batteries with an electrolyte level that is too low - risk of explosion and caustic burns.



Note

- There must not be any contact between the two vehicles otherwise current may flow as soon as the negative terminals are connected.
- The discharged battery must be properly connected to the system of the vehicle.
- We recommend you buy jump-start cables from a car battery specialist.

Jump-starting

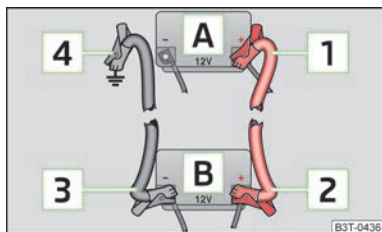

Fig. 153
Jump-starting using the battery from another vehicle: A - flat vehicle battery, B - battery providing current

First read and observe the introductory information and safety warnings on page 185.

The jump-start cables must be attached in the following sequence.

Connecting positive terminals

- > Attach one end » Fig. 153 to the positive terminal of the discharged battery .
- > Attach the other end to the positive terminal of the battery supplying the power .

Connecting negative terminal and engine block

- > Attach one end » Fig. 153 to the negative terminal of the battery supplying the power .
- > Attach the other end to a solid metal part which is connected firmly to the engine block, or to the engine block itself.

Starting engine

- > Start the engine on the vehicle providing the power and allow it to idle.
- > Now start the engine of the vehicle with the discharged battery.
- > If the engine does not start, terminate the attempt to start the engine after 10 seconds and wait for about 30 seconds before repeating the process.
- > Disconnect the cables in exactly the **reverse order** to the one described above. ■

Jump-starting in vehicles with the START-STOP system



Fig. 154
Jump-starting - START-STOP system

First read and observe the introductory information and safety warnings on page 185.

On vehicles with the START-STOP system, the jump-start cable of the charger must never be connected directly to the negative pole of the vehicle battery, but only to the engine earth » Fig. 154. ■

Towing the vehicle

Introduction

This chapter contains information on the following subjects:

Front towing eye	187
Front towing eye for Octavia RS and Octavia Scout	188
Rear towing eye	188

Vehicles with manual transmission can be towed in with a tow bar or a tow rope or with the front or rear wheels raised.

Vehicles with automatic transmission can be towed in with a tow bar or a tow rope or with the front wheels raised. If the vehicle is raised at rear, the automatic gearbox is damaged!

A **tow bar** is the safest way of towing a vehicle and also minimises any shocks. Only use a **tow rope** if a suitable tow bar is not available.

When towing, the following guidelines must be observed. ►

Driver of the tow vehicle

- Release the clutch particularly gently when starting off or depress the accelerator particularly gently if the vehicle is fitted with an automatic gearbox.
- On vehicles with a manual transmission, only push down on the accelerator pedal once the rope is taught.

The maximum towing speed is **50 km/h**.

Driver of the towed vehicle

- Switch on the ignition so that the steering wheel is not blocked and so that the turn signal lights, horn, windscreen wipers and windscreen washer system can be switched on.
- Take the vehicle out of gear or move the selector lever into position **N** if the vehicle is fitted with an automatic gearbox.

Please note that the brake servo unit and power steering only operate if the engine is running. If the engine is not running, significantly more physical force is required to depress the brake pedal and steer the vehicle.

If using a tow rope, ensure that it is always kept taught.

! CAUTION

- Do not tow start the engine - danger of damaging the engine! On vehicles with a catalytic converter, unburnt fuel may get into the catalytic converter where it may ignite. This in turn may damage or destroy the catalytic converter. The battery from another vehicle can be used as a jump-start aid » [page 185](#), *Jump-starting*.
- If the gearbox of your vehicle no longer contains any oil because of a defect, your vehicle must only be towed in with the driven wheels raised clear of the ground, or on a special vehicle transporter or trailer.
- The vehicle must be transported on a special vehicle or trailer if it is not possible to tow in the vehicle in the way described or if the towing distance is greater than 50 km.
- To protect both vehicles when tow-starting or towing, the tow rope should be elastic. Thus one should only use plastic fibre rope or a rope made out of a similarly elastic material.
- One should be constantly vigilant not to allow impermissibly high towing forces or jerky loadings. There is always a risk of excessive stresses and damage resulting at the points to which you attach the tow rope or tow bar when you attempt to tow a vehicle which is not standing on a paved road.
- Attach the tow rope or the tow bar to the **towing eyes** or to the **detachable ball head of the towing device** » [page 187](#) or » [page 188](#).

i Note

- We recommend using a tow rope from ŠKODA Original Accessories available from a ŠKODA Service Partner.
- Towing another vehicle requires a certain amount of practice. Both drivers should be familiar with the particular points about towing a vehicle. Unskilled drivers should not attempt to tow in another vehicle or to be towed in.
- When towing, respect the national legal provisions, especially those which relate to the identification of the towing vehicle and the vehicle being towed.
- The tow rope must not be twisted as it may in certain circumstances result in the front towing eye being unscrewed out of your vehicle.

Front towing eye

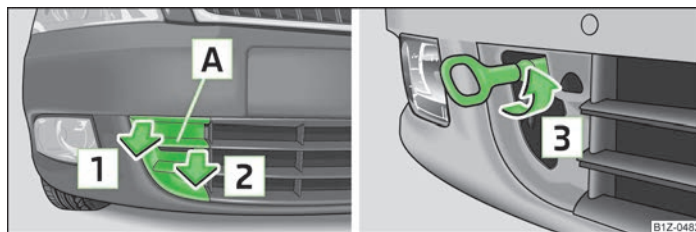

Fig. 155 Front bumper: protective grille/installing the towing eye

 **First read and observe the introductory information and safety warnings  on page 186.**

Remove the cap carefully as follows.

- Insert your fingers into opening **A** » [Fig. 155](#).
- By pulling in the direction of arrow **1**, first of all undo the cover in the upper area on the side facing the fog light.
- Afterwards, undo the cover in the direction of arrow **2** on the other side too, remove.
- Manually insert the towing eye in the direction of arrow **3** until the stop, tighten. For tightening purposes, we recommend, for example, using the wheel wrench, towing eye from another vehicle or a similar object that can be pushed through the eye.

- In order to reinstall the cap after unscrewing the towing eye, first of all insert it starting on the side facing the marking. Then press the cap on the side closest to the fog light. The cap must engage firmly.

! CAUTION

The towing eye must always be screwed in fully and firmly tightened, otherwise the towing eye can tear when towing in or tow-starting.

Front towing eye for Octavia RS and Octavia Scout

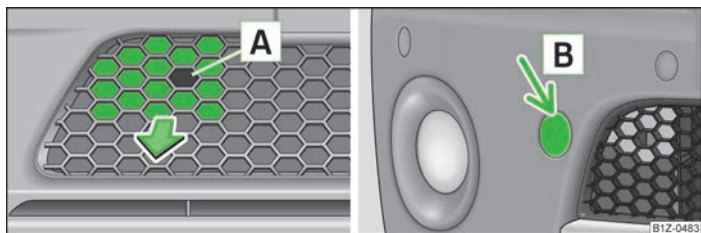

Fig. 156 Front bumper Octavia RS: Protective grille/Octavia Scout: Cap

First read and observe the introductory information and safety warnings **!** on page 186.

Octavia RS

- Insert a finger into the opening **A** » Fig. 156 of the grille.
- Unlock and remove the cap by pulling in the direction of arrow.
- Manually insert the towing eye in the direction of arrow **3** » Fig. 155 on page 187 until the stop, tighten. For tightening purposes, we recommend, for example, using the wheel wrench, towing eye from another vehicle or a similar object that can be pushed through the eye.
- After unscrewing the towing eye, put the cap on and press into place. The cap must engage firmly.

Octavia Scout

- Press on the top area of the cap **B** » Fig. 156, remove it.
- Manually insert the towing eye in the direction of arrow **3** » Fig. 155 on page 187 until the stop, tighten. For tightening purposes, we recommend, for example, using the wheel wrench, towing eye from another vehicle or a similar object that can be pushed through the eye.

- After unscrewing the towing eye, put the cap on and press into place. The cap must engage firmly.

! CAUTION

The towing eye must always be screwed in fully and firmly tightened, otherwise the towing eye can tear when towing in or tow-starting.

Rear towing eye

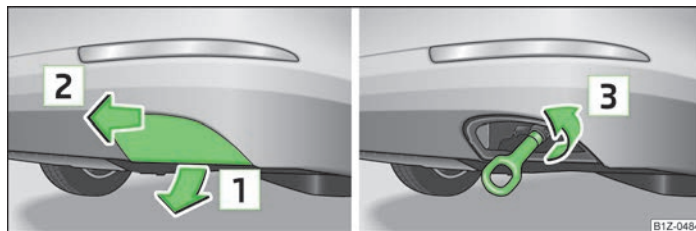

Fig. 157 Rear bumper: removing the cap/rear bumper: Installing the towing eye

First read and observe the introductory information and safety warnings **!** on page 186.

- Unlock the bottom part of the cap by pulling it downwards in direction of arrow **1** » Fig. 157.
- Unlock the upper area of the cap by pulling in the direction of the arrow **2**, remove the cap.
- Manually insert the towing eye in the direction of arrow **3** until the stop, tighten. For tightening purposes, we recommend, for example, using the wheel wrench, towing eye from another vehicle or a similar object that can be pushed through the eye.
- To re-insert the cap after removing the towing eye, first insert it with the upper area, afterwards press the lower area too. The cap must engage firmly.

! CAUTION

The towing eye must always be screwed in fully and firmly tightened, otherwise the towing eye can tear when towing in or tow-starting.

Fuses and light bulbs

Fuses

Introduction

This chapter contains information on the following subjects:

Fuses in the dash panel _____ 190

Fuses in the engine compartment _____ 191

Individual electrical circuits are protected by fuses.

- Before replacing a fuse, switch off the ignition and the appropriate consumer
- Find out which fuse belongs to the component that is not operating » [page 190](#), *Fuses in the dash panel* or » [page 191](#), *Fuses in the engine compartment*.
- Take the plastic clip out of its fixture in the cover of the fuse box, place it on the relevant fuse and pull it out.
- A blown fuse is recognisable by the molten metal strip. Replace the faulty fuse with a new one of the **same** amperage.

Colour coding of fuses

Colour	Maximum amperage
light brown	5
dark brown	7.5
red	10
blue	15
yellow	20
white	25
green	30
orange	40
red	50

! WARNING

Always read and observe the warnings before completing any work in the engine compartment » [page 158](#), *Engine compartment*.

! CAUTION

- Never "repair" fuses and also do not replace them with a fuse of a higher amperage - risk of fire! This may also cause damage at another part of the electrical system.
- Have the electrical system checked as quickly as possible by a ŠKODA specialist garage if a newly inserted fuse blows again after a short time.
- When unlocking and locking the cover for the fuse box in the engine compartment, it must be pressed on the sides of the box, otherwise the locking mechanism can be damaged.
- The cover for the fuse box in the engine compartment must always be applied correctly. Water can penetrate and cause damage to the vehicle if the cover was not applied correctly!



i Note

- We recommend always carrying replacement fuses in the vehicle. A box of replacement fuses can be purchased from ŠKODA Original Accessories.
- Multiple fuses may exist for a single power consuming device.
- Multiple power consuming devices can share a single fuse.
- Electrically adjustable seats are protected by **automatic circuit breakers**, which switch on again automatically after a few seconds after the overload has been eliminated.

Fuses in the dash panel



Fig. 158 Fuse box cover in the dash panel/schematic diagram of the fuse box

 First read and observe the introductory information and safety warnings  on page 189.

The fuses are located on the left side of the dash panel behind a cover.

- Remove the cover for the fuse box using a screwdriver » Fig. 158.
- Replace the cover once the fuse has been changed.

Fuse assignment in the dash panel

No.	Power consumer
1	Diagnostic socket, engine control unit, fuel pump
2	Control unit for ABS, ESC
3	Airbag
4	Heating, Air conditioning system, Reversing lights
5	Control unit for headlamp beam adjustment
6	Instrument cluster, control unit for automatic gearbox, control unit for electromechanical power steering, parking aid
7-11	Not assigned
12	Central locking control unit
13	Diagnostic socket, Light switch
14	Control unit for automatic gearbox, Selector lever lock
15	Vehicle voltage control unit - interior lights
16	Climatronic

No.	Power consumer
17	Not assigned
18	Rear window wiper
19	Control unit for trailer detection
20	Not assigned
21	Cornering lights for the left and right side
22	Air blower for Climatronic
23	Front power window
24	Cigarette lighter
25	Rear window heater, auxiliary heating and ventilation
26	Power socket in the boot
27	Fuel pump, Injection valves (diesel engine)
28	Radio
29	Engine control unit, Crankcase ventilation heater
30	Control unit for automatic gearbox, Haldex
31	Vacuum pump
32	Rear power window
33	Electric sliding/tilting roof
34	Control unit for convenience functions
35	Alarm
36	Headlight cleaning system
37	Heated front seats
38	Heated rear seats
39	Instrument cluster, windscreen wiper lever, and turn signal lever
40	Air blower for heating and air conditioning
41-42	Not assigned
43-45	Towing device
46	Seat heaters
47	Auxiliary heating and ventilation
48	Phone
49	Light switch

Fuses in the engine compartment

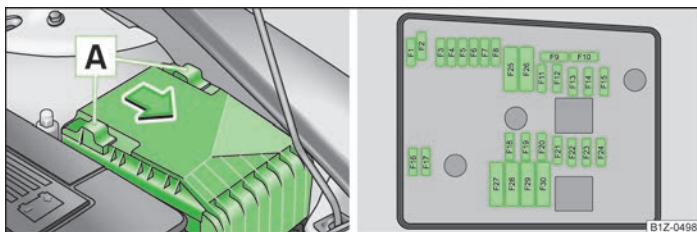

Fig. 159 Fuse box cover in engine compartment/Schematic diagram of the fuse box

First read and observe the introductory information and safety warnings on page 189.

On some vehicles, the battery cover must be removed before removing the cover for the fuse box » [page 167](#).

- The cover for the fuse box is removed by pushing the circlips **A** » [Fig. 159](#) upwards as far as the stop. The symbol is displayed behind the clip. Now remove the cover.
- Once the fuse has been removed, place the cover on the fuse box and push the circlips **A** back as far as the stop. The symbol is displayed behind the clip. The cover is locked into position.

Fuse assignment in engine compartment

No.	Power consumer
F1	Not assigned
F2	Control unit for automatic gearbox
F3	Measuring circuit
F4	Valves for ABS
F5	Control unit for automatic gearbox
F6	Instrument cluster, windscreen wiper lever, and turn signal lever
F7	Power supply terminal 15, Starter
F8	Radio
F9	Not assigned

No.	Power consumer
F10	Engine control unit
F11	Auxiliary heating and ventilation control unit
F12	Data bus control unit
F13	Engine control unit
F14	Ignition
F15	Lambda probe, glow plug system
F16	Vehicle voltage control unit, right headlight, right tail light
F17	Horn
F18	Amplifier for the digital sound processor
F19	Windscreen wipers
F20	Coolant pump, valve for fuel dosing
F21	Lambda probe
F22	Clutch pedal switch, brake pedal switch
F23	Secondary air pump, air mass meter, fuel high pressure pump
F24	Active charcoal filter, exhaust gas recirculation valve, radiator fan
F25	Pump for ABS
F26	Vehicle voltage control unit, left headlight, left tail light
F27	Secondary air pump, glow plug system
F28	Not assigned
F29	Power supply terminal 30
F30	Terminal X ^{a)}

^{a)} In order not to drain the battery unnecessarily when starting the engine, the electrical components of this terminal are automatically switched off.

Bulbs

Introduction

This chapter contains information on the following subjects:

Headlights	_____	192
Changing the bulb for the front turn signal light	_____	193
Changing light bulbs for front parking lights and low beam	_____	193
Changing the bulb for the main beam	_____	194 ▶

Fog lights and daytime running lights	194
Fog lights Octavia RS, Octavia Scout	195
Changing the bulb for the licence plate light	195
Tail lamp assembly	196
Tail light (Combi)	196

Some manual skills are required to change a bulb. For this reason, if uncertain, we recommend that bulbs are replaced by a ŠKODA specialist garage or other expert help is sought.

- Switch off the ignition and all of the lights before replacing a bulb.
- Faulty bulbs must only be replaced with the same type of bulbs. The designation is located on the light socket or the glass bulb.
- A stowage compartment for replacement bulbs is located in a plastic box in the spare wheel or underneath the floor covering in the boot.

! WARNING

- Accidents can be caused if the road in front of the vehicle is not sufficiently illuminated and the vehicle cannot or can only be seen with difficulty by other road users.
- Always read and observe the warnings before completing any work in the engine compartment » [page 158, Engine compartment](#).
- Bulbs H7 and H1 are pressurised and may burst when changing the bulb - risk of injury! We therefore recommended wearing gloves and safety glasses when changing a bulb.
- Gas discharge bulbs (xenon bulbs) operate with a high voltage, professional knowledge is required - danger to life!

! CAUTION

- Do not take hold of the glass bulb with naked fingers (even the smallest amount of dirt reduces the working life of the light bulb). Use a clean cloth, napkin, or similar.
- When removing and installing the headlight make sure that the paintwork of the vehicle and the headlight are not damaged.

i Note

- This Owner's Manual only describes the replacement of bulbs where it is possible to replace the bulbs on your own without any complications arising. Other light bulbs should be changed by a ŠKODA specialist garage.
- We recommend that a box of replacement bulbs be always carried in the vehicle. Replacement bulbs can be purchased from ŠKODA Original Accessories.
- We recommend that the headlight settings are checked by a ŠKODA specialist garage after replacing a bulb in the main or low beam.
- Gas discharge bulbs and LED diodes are replaced by a ŠKODA specialist garage. ■

Headlights

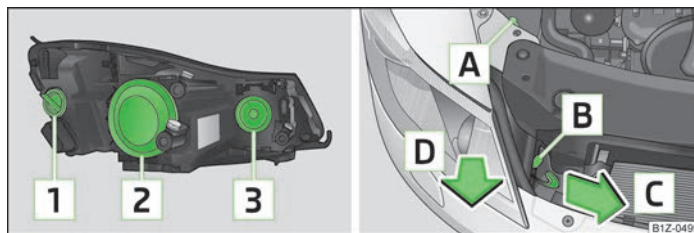

Fig. 160 Headlights: Bulb arrangement/removal

First read and observe the introductory information and safety warnings **! on page 191.**

Overview of the location of the bulbs » [Fig. 160](#).

- 1** - front turn signal light
- 2** - parking lights and low beam
- 3** - main beam light

The headlight must be removed in order to change the light bulb of the parking lights, low beam lights and main beam lights as well as the turn signal lights.

Removing the main beam lights

- Open the bonnet » [page 160, Opening and closing the bonnet](#).
- Unscrew the plastic nuts **A** » [Fig. 160](#).
- Pull the locking button **B** upwards.

- Pull the locking lever on the headlight as far as the stop in the direction of arrow **C**.
- Disconnect the plug connection and carefully remove the head light in the direction of arrow **D**.

Installation is carried out in the reverse order.

Changing the bulb for the front turn signal light



Fig. 161
Removing light bulb for turn signal light

 First read and observe the introductory information and safety warnings **I** on page 191.

- Remove the head light » page 192.
- Turn the socket in the direction of arrow **OPEN** and remove it together with the warning light bulb » Fig. 161.
- Push in the bulb into the socket, turn counter-clockwise up to the stop and remove.
- Insert a new bulb into the socket and turn **clockwise** up to the stop.
- Insert the socket with the new bulb into the headlamp. Secure it by turning it in the direction of arrow **CLOSE**.

Changing light bulbs for front parking lights and low beam

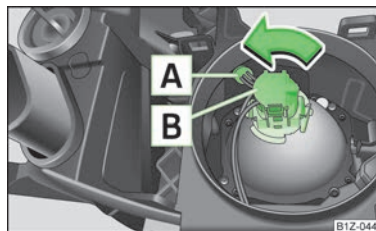

Fig. 162
Removing light bulbs for front parking lights and low beam

 First read and observe the introductory information and safety warnings **I** on page 191.

In order to facilitate the removal of the socket with the bulb for the parking light, we recommend to remove first of all the connector for the low beam light bulb.

- Remove the head light » page 192.
- Remove the rubber cover **Z** » Fig. 160 on page 192.
- To replace the bulb for the **low beam**, turn the connector with the bulb **B** » Fig. 162 **counter-clockwise** up to the stop, and remove.
- Replace the lamp, insert the connector with the new bulb and turn **clockwise** up to the stop.
- To remove the bulb for the **front parking light**, remove the holder **A**.
- Remove the faulty bulb from the socket, insert a new bulb, and insert the socket containing the bulb.
- Insert the rubber cover.

Changing the bulb for the main beam

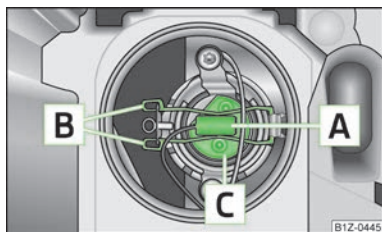

Fig. 163
Removing the bulb for the main beam

First read and observe the introductory information and safety warnings on page 191.

- > Remove the head light » page 192.
- > Remove the rubber cover » Fig. 160 on page 192.
- > Remove connector » Fig. 163.
- > Press the circlip in the direction of the head lamp and then unhook to the side.
- > Remove the light bulb and insert a new light bulb in such a way that the fixing lugs of the light bulb socket fit into the recesses at the reflector.

Installation is carried out in the reverse order.

Fog lights and daytime running lights

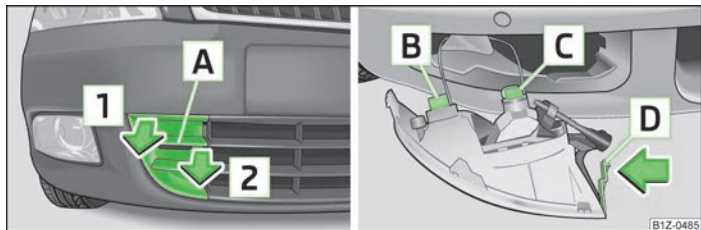

Fig. 164 Front bumper: Protective grille/removing the fog light

First read and observe the introductory information and safety warnings on page 191.

Bulb arrangement » Fig. 164.

- Bulb for daytime running light

- Light bulb for fog lights

Removing the cap

- > Insert your fingers into opening » Fig. 164.
- > By pulling in the direction of arrow , first of all undo the cover in the upper area on the side facing the fog light.
- > Afterwards, undo the cover in the direction of arrow on the other side too, remove.

Replacing light bulbs for fog lights/daytime running lights

- > Insert your hand into the opening left by the cap and press the lug » Fig. 164 in the direction of the arrow.
- > Remove the front fog lamp.
- > Turn the connector with the bulb in **counter-clockwise** up to the stop and remove.
- > Replace the lamp, insert the connector with the new bulb and turn **clockwise** up to the stop.
- > To re-install the fog light, first of all place the fog light with the lug on the side opposite the licence plate.
- > Press in the fog lamp on the side closest to the licence plate.
- > In order to reinstall the cap, first of all insert it starting on the side facing the marking. Then press the cap on the side closest to the fog light. The cap must engage firmly.

Fog lights Octavia RS, Octavia Scout

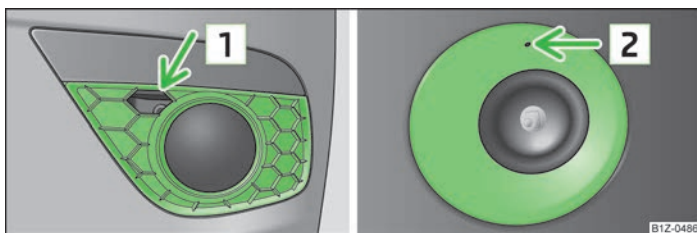

Fig. 165 Front bumper: Octavia RS/Octavia Scout

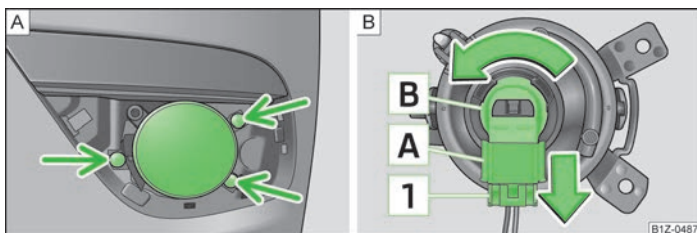



Fig. 166 Front bumper: Fog lights/fog lights: Replacing the light bulb

 First read and observe the introductory information and safety warnings  on page 191.

Removing the cap and fog light

- Insert a finger into the opening **1** » Fig. 165 (Octavia RS) and remove the cap.
- Insert the wire clamp » page 179, *Vehicle tool kit* into the opening **2** (Octavia Scout) above the fog light and remove the cap.
- Unscrew the screws with a screwdriver » Fig. 166 - **A**.
- Remove the front fog lamp.

Changing light bulbs and installing fog lights

- Press the locking button **1** » Fig. 166 of the plug **A** and remove the plug from the socket **B**.
- Turn the socket **B** with the bulb counter-clockwise up to the stop and remove.

- Replace the bulb, insert the socket with the new bulb and turn **clockwise** up to the stop.
- Insert the plug **A** into the socket **B**.
- Retighten the screws and insert the cap. The cap must engage firmly.

Changing the bulb for the licence plate light

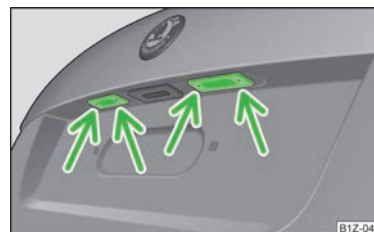

Fig. 167
Remove the licence plate light

 First read and observe the introductory information and safety warnings  on page 191.

- Open the luggage compartment door and unscrew the glass cover » Fig. 167.
- Remove the faulty bulb from the holder and insert a new one.
- Replace the glass cover and push in until the stop. Make sure that you install the rubber seal in the right direction.
- Slightly screw the glass cover.

Tail lamp assembly

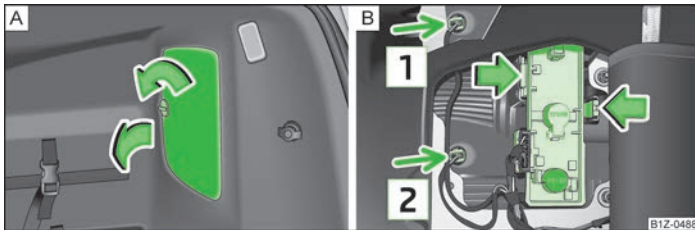

Fig. 168 Boot: Cover of the lamp holder/removing the lamp holder

First read and observe the introductory information and safety warnings on page 191.

Replacing the light bulbs in the lamp holder

- > Unlock the cover of the lamp holder, open » Fig. 168 - [A].
- > Press the catches in the direction of the arrow and remove the lamp holder » Fig. 168 - [B].
- > Push in the bulb into the socket, turn counter-clockwise up to the stop and remove.
- > Insert a new bulb into the socket and turn in a **clockwise direction** to the the stop.
- > Replace the lamp holder so that the catches engage in the housing of the tail light.
- > Close and lock the cover of the lamp holder.

Change the light bulb for the parking light

- > Unlock the cover of the lamp holder, open » Fig. 168 - [A].
- > Remove the faulty light bulb (arrow [1] or [2]) from the housing of the tail light, replace, and re-insert.
- > Close and lock the cover of the lamp holder.

Tail light (Combi)

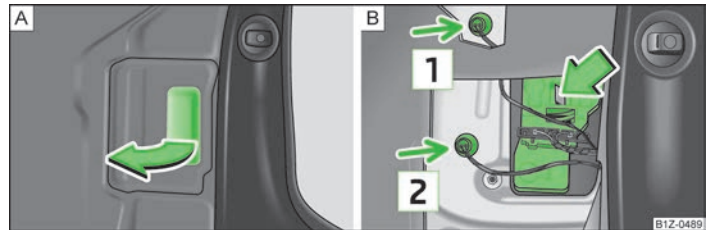

Fig. 169 Boot: Cover of the lamp holder/removing the lamp holder

First read and observe the introductory information and safety warnings on page 191.

Replacing the light bulbs in the lamp holder

- > Open the lamp holder cover » Fig. 169 - [A].
- > Remove the bulbs for the parking lights (arrow [1] and [2]).
- > Press the catch in the direction of the arrow and remove the lamp holder » Fig. 169 - [B].
- > Push in the bulb into the socket, turn counter-clockwise up to the stop and remove.
- > Insert a new bulb into the socket and turn in a **clockwise direction** to the the stop.
- > Replace the lamp holder so that the catch engages in the housing of the tail light.
- > Reinsert the bulbs for the parking lights (arrow [1] and [2]).
- > Close the lamp holder cover.

Change the light bulb for the parking light

- > Open the lamp holder cover » Fig. 169 - [A].
- > Remove the faulty light bulb (arrow [1] or [2]) from the housing of the tail light, replace, and re-insert.
- > Close the lamp holder cover.

Technical data

Technical data

Introductory information

The details given in the vehicle's technical documentation always take precedence over the details in the Owner's Manual. Please refer to the official vehicle registration documents or consult a ŠKODA Service Partner to determine which engine your vehicle is equipped with.

The listed performance values were determined without performance-reducing equipment, e.g. air conditioning system.

Vehicle identification number (VIN)

The vehicle identification number - VIN (vehicle body number) is stamped into the engine compartment on the right hand suspension strut dome. This number is also located on a sign on the lower left hand edge below the windscreen (together with a VIN bar code).

Engine number

The engine number is stamped into the engine block.

Data on the vehicle data sticker and the type plate

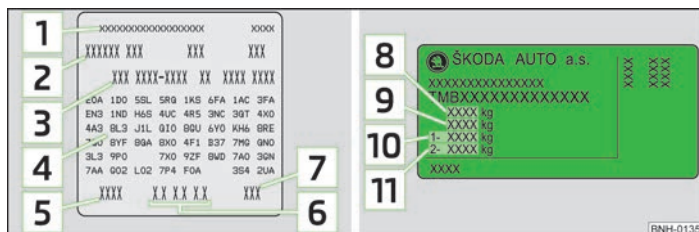

Fig. 170 Vehicle data sticker/type plate

Vehicle data sticker

The vehicle data sticker » Fig. 170 is located on the floor of the boot and is also stated in the service schedule.

The vehicle data sticker contains the following data:

- 1 Vehicle identification number (VIN)
- 2 Vehicle type
- 3 Gearbox code/paint number/interior equipment/engine output/engine code
- 4 Partial vehicle description
- 5 Operating weight (in kg)
- 6 Fuel consumption (in ltr./100 km) - intra-urban/extra-urban/combined
- 7 CO₂ emission levels - combined (in g/km)

Type plate

The type plate » Fig. 170 is located on the lower part of the column between the front and rear doors on the driver's side.

The type plate lists the following weights:

- 8 Maximum permissible gross weight
- 9 Maximum permissible towed weight (towing vehicle and trailer)
- 10 Maximum permissible front axle load
- 11 Maximum permissible rear axle load

Operating weight

The specified operating weight is for orientation purposes only. This value represents the minimum operating weight without additional weight-increasing equipment such as air conditioning system, spare wheel, or trailer hitch.

The operating weight also contains the weight of the driver (75 kg), the weight of the operating fluids, the tool kit, and a fuel tank filled to 90 % capacity.

It is possible to calculate the approximate loading capacity from the difference between the permissible total weight and the operating weight » **!**

The payload consists of the following components:

- » Passengers
- » All items of luggage and other loads
- » Roof load including roof rack system
- » Equipment not included in the operating weight
- » Trailer drawbar load when towing a trailer (max. 80 kg).

Measuring the fuel consumption and CO₂ emissions according to the ECE standards and EU guidelines

The measurement of the intra-urban cycle begins with a cold start of the engine. Afterwards urban driving is simulated.

In the extra-urban driving cycle, the vehicle is accelerated and decelerated in all gears, corresponding to daily routine driving conditions. The driving speed varies between 0 and 120 km/h.

The calculation of the combined fuel consumption considers a weighting of about 37 % for the intra-urban cycle and 63 % for the extra-urban cycle.

! WARNING

Do not exceed the specified maximum permissible weights - risk of accident and damage.

i Note

- If required, you can find out the precise weight of your vehicle by contacting a ŠKODA Service Partner.
- Depending on the range of equipment, style of driving, traffic situation, weather influences and vehicle condition, consumption values may deviate from the indicated values.

Dimensions

Dimensions (mm)

	OCTAVIA	OCTAVIA GreenLine	OCTAVIA RS	ESTATE	ESTATE GreenLine	ESTATE RS	COMBI 4x4	SCOUT
Length	4569 4597 ^{a)}	4569	4597	4569 4584 ^{b)}	4569	4599	4569	4584
Width	1769	1769	1769	1769 1784 ^{b)}	1769	1769	1769	1784
Width including exterior mirror	2018	2018	2018	2018	2018	2018	2018	2018
Height	1462 1485 ^{c)} 1449 ^{d)} 1484 ^{a)}	1462 1449 ^{d)}	1447	1468 1490 ^{c)} 1455 ^{d)} 1501 ^{b)}	1468 1455 ^{d)}	1451	1495 1520 ^{c)}	1533
Clearance	140 164 ^{c)} 125 ^{d)}	140 125 ^{d)}	127	140 164 ^{c)} 125 ^{d)} 179 ^{b)}	140 125 ^{d)}	128	138 163 ^{c)}	179

	OCTAVIA	OCTAVIA GreenLine	OCTAVIA RS	ESTATE	ESTATE GreenLine	ESTATE RS	COMBI 4x4	SCOUT
Wheel base	2578	2578	2578	2578	2578	2578	2578	2578
Track gauge front/rear	1541/1514	1535/1508	1528/1508	1541/1514 1531/1500 ^{b)}	1535/1508	1528/1508	1541/1514	1531/1500

a) Applies to vehicles with the LOOK RS package.

b) Applies to vehicles with a 1.8 l/112 kW TSI engine AG6.

c) Applies to vehicles with a rough road package.

d) Applies to vehicles with a SPORT package.

Specifications and engine oil capacity

The engine has been factory-filled with a high-grade oil that can be used throughout the year - except in extreme climate zones.

Various oils can be mixed together when refilling. However, this does not apply to vehicles with flexible service intervals.

Engine oils are, of course, undergoing continuous further development. Thus the information stated in this Owner's Manual is only correct at the time of publication.

ŠKODA Service Partners are informed about the latest changes by ŠKODA. We therefore recommend that the oil change is completed by a ŠKODA Service Partner.

The specifications (VW standards) stated in the following can be indicated separately or together with other specifications on the bottle.

The oil capacities include oil filter change. Check the oil level when filling; do not over fill. The oil level must be between the markings » [page 161](#).

Specifications and capacity (in l) for vehicles with flexible service intervals

Petrol engines	Specification	Filling level
1.2 ltr./77 kW TSI	VW 504 00	3.9
1.4 l/59 kW	VW 503 00, VW 504 00	3.2
1.4 ltr./90 kW TSI	VW 504 00	3.6
1.6 l/75 kW	VW 503 00, VW 504 00	4.5
1.6 ltr./75 kW MultiFuel	VW 503 00, VW 504 00	4.5
1.8 ltr./118 kW TSI	VW 504 00	4.6
1.8 ltr./112 kW TSI	VW 504 00	4.6
2.0 ltr./147 kW TSI	VW 504 00	4.6

Diesel engines	Specification	Filling level
1.6 ltr./77 kW TDI CR	VW 507 00	4.3
1.9 l/77 kW TDI PD	VW 506 01, VW 507 00	3.8
1.9 ltr./77 kW TD PD DPF	VW 507 00	4.3
2.0 ltr./81 kW TDI CR	VW 507 00	4.3
2.0 ltr./103 kW TDI CR DPF	VW 507 00	4.3
2.0 ltr./125 kW TDI CR	VW 507 00	4.3

Specifications and capacity (in l) for vehicles with fixed service intervals

Petrol engines	Specification	Filling level
1.2 ltr./77 kW TSI	VW 502 00	3.9
1.4 l/59 kW	VW 501 01, VW 502 00	3.2
1.4 ltr./90 kW TSI	VW 502 00	3.6
1.6 l/75 kW	VW 501 01, VW 502 00	4.5
1.6 ltr./75 kW MultiFuel	VW 502 00	4.5
1.8 ltr./118 kW TSI	VW 502 00	4.6
1.8 ltr./112 kW TSI	VW 502 00	4.6
2.0 ltr./147 kW TSI	VW 502 00	4.6

If the oils specified above are not available, oils according to ACEA A2 or ACEA A3 can be used once for refilling.

Diesel engines	Specification	Filling level
1.6 ltr./77 kW TDI CR	VW 507 00	4.3
1.9 l/77 kW TDI PD	VW 505 01	3.8
1.9 ltr./77 kW TD PD DPF	VW 507 00	4.3
2.0 ltr./81 kW TDI CR	VW 507 00	4.3
2.0 ltr./103 kW TDI CR DPF	VW 507 00	4.3
2.0 ltr./125 kW TDI CR	VW 507 00	4.3

If the oils specified above are not available, oils according to ACEA B3 or ACEA B4 can be used once for refilling.

CAUTION

Only the above-mentioned oils can be used on vehicles with flexible service intervals. We recommend always refilling with oil of the same specification since this will maintain the properties of the oil. In exceptional cases, a maximum of 0.5 l of specification VW 502 00 (only for petrol engines) or specification VW 505 01 (only for diesel engines) engine oil can be used to refill once. Other engine oils must not be used - risk of engine damage!

Note

- Before a long drive we recommend that you purchase and carry with you engine oil which complies with the specification for your vehicle.
- We recommend that you use oils from ŠKODA Original Accessories. ■

Vehicle-specific information depending on engine type

1.2 ltr./77 kW TSI engine

Output (kW per rpm)	Max. torque (Nm at rpm)	Number of cylinders/Displacement (cm ³)
77/5000	175/1550-4100	4/1197

Performances	OCTAVIA MG6	OCTAVIA DSG7	COMBI MG6	COMBI DSG7
Top speed (km/h)	192		191	191
Acceleration 0 - 100 km/h (s)	10.8		10.9	10.9
Permissible trailer load, braked (kg)	1200 ^{a)} /1400 ^{b)} (1200 ^{a)} / ^{b)} ^{c)}			
Permissible trailer load, unbraked (kg)	630	640	630	640

^{a)} Uphills up to 12 %

^{b)} Uphills up to 8 %

^{c)} Class N1 vehicles.

1.4 ltr./59 kW engine

Output (kW per rpm)	Max. torque (Nm at rpm)	Number of cylinders/Displacement (cm ³)
59/5000	132/3800	4/1390

Performances	OCTAVIA EU4	OCTAVIA EU5	COMBI EU4	COMBI EU5
Top speed (km/h)	173	174	172	173
Acceleration 0 - 100 km/h (s)	14.2	14.3	14.3	14.4
Permissible trailer load, braked (kg)	900 ^{a)} /1100 ^{b)}		900 ^{a)} /1100 ^{b)} (900 ^{a)} / ^{b)} ^{c)}	900 ^{a)} /1100 ^{b)}
Permissible trailer load, unbraked (kg)	620			

^{a)} Uphills up to 12 %

^{b)} Uphills up to 8 %

^{c)} Class N1 vehicles.

1.4 ltr./90 kW TSI engine

Output (kW per rpm)	Max. torque (Nm at rpm)	Number of cylinders/Displacement (cm ³)
90/5000	200/1500-4000	4/1390

Performances	OCTAVIA MG6	OCTAVIA DSG7	COMBI MG6	COMBI DSG7
Top speed (km/h)	203/205 ^{a)}	202	202/204 ^{a)}	201
Acceleration 0 - 100 km/h (s)	9.7/9.8 ^{a)}	9.7	9.8/9.9 ^{a)}	9.8
Permissible trailer load, braked (kg)	1300 ^{b)} /1500 ^{c)} (1300 ^{b)c)} ^{d)}			
Permissible trailer load, unbraked (kg)	650	660	650	660

^{a)} The value corresponds to the status with the Green tec-package.

^{b)} Uphills up to 12 %

^{c)} Uphills up to 8 %

^{d)} Class N1 vehicles.

1.6 ltr./75 kW engine

Output (kW per rpm)	Max. torque (Nm at rpm)	Number of cylinders/Displacement (cm ³)
75/5600	148/3800	4/1595

Performances	OCTAVIA MG5 EU4	OCTAVIA MG5 EU5	OCTAVIA MG5 MultiFuel	OCTAVIA AG6	COMBI MG5 EU4	COMBI MG5 EU5	COMBI MG5 MultiFuel	COMBI AG6
Top speed (km/h)	190			184	188	189	188	184
Acceleration 0 - 100 km/h (s)	12.3			14.1	12.4	12.4	12.4	14.2
Permissible trailer load, braked (kg)	1200 ^{a)} /1400 ^{b)} (1200 ^{a)b)c)}							
Permissible trailer load, unbraked (kg)	630			650	630			650

^{a)} Uphills up to 12 %

^{b)} Uphills up to 8 %

^{c)} Class N1 vehicles.

1.8 ltr./112 kW TSI engine

Output (kW per rpm)	Max. torque (Nm at rpm)	Number of cylinders/Displacement (cm ³)
112/4300-6200	250/1500-4200	4/1798

Performances	OCTAVIA MG6	OCTAVIA AG6	COMBI MG6	COMBI AG6	COMBI 4x4 MG6	SCOUT MG6
Top speed (km/h)	219	214	218	213	214	208
Acceleration 0 - 100 km/h (s)	8.1	8.8	8.2	8.9	8.4	8.7
Permissible trailer load, braked (kg)	1400 ^{a)} /1600 ^{b)} (1400 ^{a)} / ^{b)} / ^{c)}			1500 ^{a)} /1600 ^{b)} (1500 ^{a)} / ^{b)} / ^{c)}		
Permissible trailer load, unbraked (kg)	670	690	670	690	730	750

^{a)} Uphills up to 12 %

^{b)} Uphills up to 8 %

^{c)} Class N1 vehicles.

1.8 ltr./118 kW TSI engine

Output (kW per rpm)	Max. torque (Nm at rpm)	Number of cylinders/Displacement (cm ³)
118/4500-6200	250/1500-4500	4/1798

Performances	OCTAVIA MG6	OCTAVIA DSG7	COMBI MG6	COMBI DSG7	COMBI 4x4 MG6	SCOUT MG6
Top speed (km/h)	223		222		218	211
Acceleration 0 - 100 km/h (s)	7.8		7.9		8.1	8.4
Permissible trailer load, braked (kg)	1400 ^{a)} /1600 ^{b)} (1400 ^{a)} / ^{b)} / ^{c)}			1500 ^{a)} /1600 ^{b)} (1500 ^{a)} / ^{b)} / ^{c)}		
Permissible trailer load, unbraked (kg)	670	680	670	680	730	750

^{a)} Uphills up to 12 %

^{b)} Uphills up to 8 %

^{c)} Class N1 vehicles.

2.0 ltr./147 kW TSI engine

Output (kW per rpm)	Max. torque (Nm at rpm)	Number of cylinders/Displacement (cm ³)
147/5100-6000	280/1700-5000	4/1984

Performances	OCTAVIA RS MG6	OCTAVIA RS DSG6	COMBI RS MG6	COMBI RS DSG6
Top speed (km/h)	242	240	239	237
Acceleration 0 - 100 km/h (s)	7.2	7.2	7.3	7.3
Permissible trailer load, braked (kg)	1400 ^{a)} /1600 ^{b)} (1400 ^{a)} / ^{b)} ^{c)}			
Permissible trailer load, unbraked (kg)	650			

^{a)} Uphills up to 12 %

^{b)} Uphills up to 8 %

^{c)} Class N1 vehicles.

1.6 ltr./77 kW TDI CR engine

Output (kW per rpm)	Max. torque (Nm at rpm)	Number of cylinders/Displacement (cm ³)
77/4400	250/1500-2500	4/1598

Performances	OCTAVIA MG5	OCTAVIA MG5 GreenLine	OCTAVIA DSG7	COMBI MG5	COMBI MG5 GreenLine	COMBI DSG7	COMBI 4x4 MG6
Top speed (km/h)	191/192 ^{a)}	192	191	190/191 ^{a)}	191	190	186
Acceleration 0 - 100 km/h (s)	11.3	11.4	11.4	11.4	11.6	11.5	12.2
Permissible trailer load, braked (kg)	1400 ^{b)} /1600 ^{c)} (1400 ^{b)} / ^{c)} ^{d)}						1600 ^{b)} /1700 ^{c)} (1600 ^{b)} / ^{c)} ^{d)}
Permissible trailer load, unbraked (kg)	670		680		670	680	730

^{a)} The value corresponds to the status with the Green tec-package.

^{b)} Uphills up to 12 %

^{c)} Uphills up to 8 %

^{d)} Class N1 vehicles.

1.9 ltr./77 kW TD PD engine

Output (kW at rpm)	Max. torque (Nm at rpm)	Number of cylinders/Displacement (cm ³)
77/4000	250/1900	4/1896

Performances	OCTAVIA MG5	OCTAVIA DSG6	COMBI MG5	COMBI DSG6	COMBI 4x4 MG6
Top speed (km/h)	192	189	191	189	181
Acceleration 0 - 100 km/h (s)	11.8	12.2	11.9	12.3	12.9
Permissible trailer load, braked (kg)	1400 ^{a)} /1600 ^{b)} (1400 ^{a)}) ^{c)}				1600 ^{a)} /1700 ^{b)} (1600 ^{a)}) ^{c)}
Permissible trailer load, unbraked (kg)	670	680	670	680	740

^{a)} Uphills up to 12 %

^{b)} Uphills up to 8 %

^{c)} Class N1 vehicles.

2.0 ltr./81 kW TDI CR engine

	Output (kW per rpm)	Max. torque (Nm at rpm)	Number of cylinders/Displacement (cm ³)
MG5	81/4200	250/1500-2500	4/1968
MG6, DSG6		280/1750-2750	

Performances	OCTAVIA MG5	OCTAVIA MG6	OCTAVIA DSG6	COMBI MG5	COMBI MG6	COMBI DSG6	COMBI 4x4 MG6
Top speed (km/h)	195			194		193	189
Acceleration 0 - 100 km/h (s)	11.0			11.1		11.2	11.6
Permissible trailer load, braked (kg)	1500 ^{a)} /1700 ^{b)} (1500 ^{a)}) ^{c)}						1600 ^{a)} /1700 ^{b)} (1600 ^{a)}) ^{c)}
Permissible trailer load, unbraked (kg)	680	690	700	680	690	700	740

^{a)} Uphills up to 12 %

^{b)} Uphills up to 8 %

^{c)} Class N1 vehicles.

2.0 ltr./103 kW TDI CR engine

Output (kW per rpm)	Max. torque (Nm at rpm)	Number of cylinders/Displacement (cm ³)
103/4000 - EU4 103/4200 - EU5	320/1750-2500	4/1968

Performances	OCTAVIA MG6	OCTAVIA DSG6	COMBI MG6	COMBI DSG6	COMBI 4x4 MG6	COMBI 4x4 DSG6	SCOUT MG6	SCOUT DSG6
Top speed (km/h)	211	209	210	208	204	203	199	197
Acceleration 0 - 100 km/h (s)	9.5	9.6	9.6	9.7	9.8	9.9	10.1	10.2
Permissible trailer load, braked (kg)	1500 ^{a)} /1700 ^{b)} (1500 ^{a)} / ^{b)} ^{c)}				1600 ^{a)} /1700 ^{b)} (1600 ^{a)} / ^{b)} ^{c)}			
Permissible trailer load, unbraked (kg)	690	700	690	700	740		750	

^{a)} Uphills up to 12 %

^{b)} Uphills up to 8 %

^{c)} Class N1 vehicles.

2.0 ltr./125 kW TDI CR engine

Output (kW per rpm)	Max. torque (Nm at rpm)	Number of cylinders/Displacement (cm ³)
125/4200	350/1750-2500	4/1968

Performances	OCTAVIA RS MG6	OCTAVIA RS DSG6	COMBI RS MG6	COMBI RS DSG6
Top speed (km/h)	226	224	225	223
Acceleration 0 - 100 km/h (s)	8.3	8.3	8.4	8.4
Permissible trailer load, braked (kg)	1400 ^{a)} /1600 ^{b)} (1400 ^{a)} / ^{b)} ^{c)}			
Permissible trailer load, unbraked (kg)	650			

^{a)} Uphills up to 12 %

^{b)} Uphills up to 8 %

^{c)} Class N1 vehicles.

Multi-purpose vehicles (AF)

Weight (in kg)				
Engine	Maximum permissible gross weight			
1.2 ltr./77 kW TSI	MG6	DSG7		
	1820	1845		
1.4 l/59 kW	MG5			
	1755			
1.4 ltr./90 kW TSI	MG6	DSG7	MG6	
	1865	1885	1880 ^{a)}	
1.6 l/75 kW	MG5	AG6		
	1835	1870		
1.8 ltr./118 (112) kW TSI	MG6	DSG7	4x4 MG6	
	1905	1925	2010	
1.6 ltr./77 kW TDI CR	MG5	DSG7	4x4 MG6	
	1905	1930	2015	
1.9 l/77 kW TDI PD	MG5	DSG6	4x4 MG6	
	1910	1935	2020	
2.0 ltr./81 kW TDI CR	MG5	MG6	DSG6	4x4 MG6
	1926	1950	1970	2035
2.0 ltr./103 kW TDI CR	MG6	DSG6	4x4 MG6	4x4 DSG6
	1950	1970	2035	2055

^{a)} The value corresponds to the status with the Green tec-package. ■

Index

A

ABS	96
Warning light	22
Accessories	177
Active steering support	95
Adjusting	
Exterior mirror	52
Adjusting seats	122
Adjustment	
Seat	55
Aerial	149
see Radio reception	151
Airbag	129
Deployment	129
Front airbag	130
Head airbag	132
Side airbag	131
Airbag system	129
Air conditioning system	
Air outlet vents	80
Climatronic	85
Manual air conditioning system	82
Alarm	31
Anti-theft alarm system	31
Antilock brake system	96
Armrest	
Front	74
rear	60, 75
Ashtray	68
Assistance systems	
ESC	95
Assist systems	
ABS	22, 96
Cruise control systems (CCS)	99
EDS and XDS	97
ESC	22

Parking aid	98
START/STOP	100
TCS	21, 96
Auto Check Control	17
Automatic driving lamp control	40
Automatic gearbox	102
Dynamic shift programme	105
Emergency programme	106
Information for driving	102
Kickdown	105
Manual shifting of gears on the multifunction steering wheel	104
Parking	103
Selector lever-emergency unlocking	106
Selector lever lock	105
Selector lever positions	103
Starting off	103
Stopping	103
Tiptronic	104
Automatic load deactivation	169
Auxiliary heating (auxiliary heating and ventilation)	87
Avoiding damage to your vehicle	143

B

Before setting off	121
Belt tensioners	128
Bonnet	
Closing	160
Opening	160
Warning light	20
Boot	
Class N1 vehicles	61
Cover	63
Emergency unlocking	34
Fastening elements	61
Fixing nets	62
Fixing of the floor covering	63
foldable boot cover (Combi)	64
Light	47

see Boot lid	33
Unlocking the boot lid	34
Variable loading floor	64

Boot lid	33
Automatic locking	33
Warning light	21
Brake booster	95
Brake fluid	
Checking	164
Brakes	
Brake assist systems	93
Handbrake	95
Running in	139
Warning light	19
Braking	
Brake fluid	164
Braking assistant	95
Breakdown kit	182
Bulbs	
Replacing	191
Button in the driver's door	
Electric power windows	34

C

Car computer	
see Multifunction display	12
Car jack	179
Carrier	66
Catalytic converter	139
CD changer	119
Central locking button	29
Central locking system	
lock	29
unlock	28
Changes	177
Changing	
Engine oil	162
Wheel	179
Charging a vehicle battery	168

Checking			
Battery electrolyte level	167		
Brake fluid	164		
Coolant level	163		
Engine oil	161		
Oil level	161		
Windscreen washer fluid	165		
Children and safety	135		
Child safety			
Side airbag	136		
Child safety lock	27		
Child seat			
Classification	136		
ISOFIX	137		
on the front passenger seat	135		
Suitability	137		
TOP TETHER	137		
Chrome parts			
refer to Taking care of your vehicle	150		
Cigarette lighter	69		
Cleaning	148		
Artificial leather	153		
Headlight lenses	151		
Material coverings	153		
Materials	153		
Natural leather	153		
Plastic parts	150		
Wheels	152		
Clock	11		
Clothes hooks	77		
Cockpit			
12-volt power socket	70		
Ashtray	68		
Cigarette lighter	69		
General view	7		
Light	45		
Storage compartments	70		
Compartments	70		
Computer			
see Multifunction display	12		
Coolant			
Checking	163		
Replenishing	163		
Temperature gauge	9		
Correct seated position	122		
Counter for distance driven	10		
Cruise control system (CCS)	99		
D			
Dash panel insert	8		
Daylight driving light	40		
Deactivating			
an airbag	133		
Deactivating an airbag	133		
Defrosting rear window	47		
Delayed locking of the boot lid			
see Boot lid	33		
Diesel			
refer to Fuel	158		
Diesel fuel			
Operation in winter	158		
Diesel particulate filter	23		
Digital clock	11		
Dipstick	161		
Display			
Coolant temperature	9		
Service interval	10		
Distance driven	10		
Door			
Child safety lock	27		
Warning light for an open door	20		
Doors			
Emergency locking	32		
Driving			
Abroad	143		
Driving through water on the street	144		
Emissions	197		
Fuel consumption	197		
E			
Economical and environmentally friendly driving	140		
EDS	97		
Electrical power windows			
Button in the driver's door	34		
Electric power windows			
Central locking system	36		
Electric sliding/tilting roof	37		
Electronic Differential Lock	97		
Electronic immobiliser	92		
Emergency			
Automatic gearbox	106		
Changing a wheel	179		
Hazard warning light system	44		
Jump-starting	185		
locking of the doors	32		
Selector lever-unlocking	106		
Sliding roof	38		
Towing the vehicle	186		
Tyre repair	182		
Unlocking the boot lid	34		
Emissions	197		
Engine			
Running in	139		
Starting and stopping the engine	91		
Engine compartment			
Brake fluid	164		
Coolant	162		
Overview	160		
Vehicle battery	165		
Engine oil			
Capacity	200		
Changing	162		
Checking	161		
Replenishing	161		
Specification	200		
Engine revolutions counter	9		
Environment	140		
Environmental compatibility	142		

Environmentally friendly driving	140
ESC	
Operating principle	95
Warning light	22
Ethanol E85	
see fuel	157

F

Fire extinguisher	178
First-aid kit	178
Floor mats	97
Front airbag	130
Front seats	54
Fuel	155
Diesel	158
Ethanol E85	157
Fuel gauge	9
gauge	9
refer to Fuel	155
Refuelling	155
Unleaded petrol	156
Fuel consumption	140
Fuses	
Assignment	189
Replacing	189

G

Gear	
Recommended gear	11
General view	
Cockpit	7
Glow plug system	
Warning light	23
GSM	109, 112

H

Handbrake	95
Head airbag	132

Headlight cleaning system	
Headlight cleaning system	50
Headlights	
Driving abroad	143
Headlight cleaning system	50
Head restraint	58
Heating	80
Defrosting windows	81
Exterior mirror	52
Rear window	47
Recirculated air mode	82
Seats	57
Heating rear window	47
Horn	7

I

Ignition	93
Ignition lock	93
Immobiliser	92
Information display	
see MAXI DOT	15
Instrument cluster	8
Instrument lighting	43
Interior monitor	32
Internet connection	115
ISOFIX	137

J

Jacking points	
Raise vehicle	181
Jump-starting	185

L

Lever	
Main beam	45
Turn signal	45

Light

Automatic driving lamp control	40
Cockpit	45
COMING HOME/LEAVING HOME function	41
Daylight driving light	40
Fog lights	42
Fog lights with the function CORNER	42
Hazard warning light system	44
Headlight beam adjustment	44
Headlight flasher	45
Low beam	40
Main beam	45
Parking light	40, 41
Rear fog light	43
Replacing bulbs	191
Tourist light	42
Turn signal	45

Lights

Cornering lights	41
switching on and off	40
Warning lights	18

Loads	197
--------------	-----

Lock

Central locking system	29
------------------------	----

Locking

Emergency locking	32
Remote control	30

Locking and unlocking from the inside	29
--	----

Luggage compartment

Folding double hooks	62
Folding hooks	62

M

MAXI DOT	15
Main menu	15
Settings	16

Mirror

Automatic dimming interior mirror	52
Exterior mirror	52

Manual dimming interior mirror	51
Vanity	47
Mobile phone	107, 109, 112
Connecting to the hands-free system	110, 113
Multifunction display	
Functions	12
Memory	12
Operation	13
Multimedia	118
AUX-IN	119
MDI	119

N

Net partition	65
----------------------	----

O

Oil	
refer to Engine oil	161
Onboard computer	
see Multifunction display	12
Operation in winter	
De-icing windows	151
Diesel fuel	158
Vehicle battery	167
Outside temperature	13
Overview	
Engine compartment	160
Warning lights	18

P

Paint	
see Paint damage	150
Paint damage	150
Parking	
Parking aid	98
Parking ticket holder	77
Passive Safety	121
Periodic wiping	49

Petrol	
refer to Fuel	156
Polishing the paintwork	
refer to Taking care of your vehicle	150
Power steering	92
Power windows	
Button in the driver's door	35
Button in the front passenger door	36
Button in the rear doors	36
Operational faults	37
Preservation	
refer to Taking care of your vehicle	150

R

Radiator fan	164
Radio reception	
Aerial	151
Functional fault	151
Raise vehicle	181
Rear mirror	
Automatic dimming interior mirror	52
Exterior mirror	52
Manual dimming interior mirror	51
Recirculated air mode	
Climatronic	86
Manual air conditioning system	84
Recommended gear	11
Refuelling	155
Fuel	155

Regulation	
Headlight beam	44
Remote control	30
Synchronisation process	31
Remote control key	
Replacing the battery	26
Removable through-loading bag	76
Removing the seats	59
Replacement of parts	177

Replacing	
Bulbs	191
Fuses	189
Vehicle battery	168
Windscreen wiper blade	51

Replenishing	
Coolant	163
Engine oil	161
Windscreen washer fluid	165

Roof luggage rack	
Attachment points	67

Roof rack system	
Roof load	67

Running in	
Brake pads	139
Engine	139
The first 1 500 km	139
Tyres	139

S

Safe securing system	28
Safety	121
Child safety	135
Child safety seats	135
Head restraints	58
ISOFIX	137
TOP TETHER	137
Save electrical energy	140
Seat	
Adjusting	55
Seat belt	
Warning light	19
Seat belt height adjuster	128
Seat belts	
Belt tensioners	128
Cleaning	154
fastening and unfastening	127
Height adjustment	128

Seats		Sun visors	47	Trailer	145
folding forward	59	Switching lights on and off	40	Towing a trailer	145
Head restraints	58			Transport	
Heating	57	T		Boot	60
Selector lever				Roof rack system	66
see selector lever positions	103	Taking care of the vehicle		Transporting children safely	135
Selector lever positions	103	Artificial leather	153	Two-way radio systems	107
Service display	10	Material coverings	153	Type plate	197
Setting		Materials	153	Tyre repair	182
Automatic dimming interior mirror	52	Natural leather	153	Tyres	
Manual air conditioning system	84	Seat belts	154	see Wheels and tyres	172
Manual dimming interior mirror	51	Taking care of your vehicle	148		
Steering wheel	92	Automatic car wash system	149		
Setting temperature		Chrome parts	150		
Heating	81	Cleaning the wheels	152	U	
Setting the clock	11	Door lock cylinders	151	Underbody protection	152
Shifting		Headlight lenses	151	unlock	
Diving economically	140	High-pressure cleaner	149	Central locking system	28
Gearshift lever	97	Plastic parts	150	Unlocking	
Side airbag	131	Polishing the paintwork	150	Remote control	30
Sliding/tilting roof		Preservation	150	Uphill start assist	95
see Electric sliding/tilting roof	37	Rubber seals	151		
Snow chains	176	Washing	149		
Spare wheel	173	Washing by hand	149		
Speedometer	9	Wash system	149		
START/STOP		TCS	96	Vehicle battery	
Function	100	Warning light	21	Automatic load deactivation	169
Starting and stopping the engine	91	Technical data	197	Charging	168
Starting engine		Telephone	109, 112	Checking the electrolyte level	167
Jump-starting	185	Through-loading channel	75	Operation in winter	167
START STOP		Tilting roof		Replacing	168
Jump-starting	186	see Electric sliding/tilting roof	37	Safety instructions	165
Steering		Tiptronic	102	Vehicle condition	
active support	95	see automatic gearbox	104	see Auto Check Control	17
Steering force assistance	92	Tool	179	Vehicle data sticker	197
Steering wheel	92	TOP TETHER	137	Vehicle dimensions	198
Storage	70	Towing	186	Vehicle key	26
Storage compartment		Towing a trailer	145	Vehicle tool kit	179
Lighting	46	Towing eye	187	Visors	47
Storage compartments	70	Towing protection monitoring	32		
		Traction control system TCS	96		

W		Windscreen washer system _____ 165
Warning lights _____ 18		Windscreen wipers _____ 49
Warning symbols		Windscreen wiper
see Warning lights _____ 18		Automatic rear window wiper (Combi) _____ 50
Warning triangle _____ 178		Replacing the rear window wiper blade _____ 51
Washing _____ 148		Replacing the windscreen wiper blades _____ 51
Automatic car wash system _____ 149		Windscreen wipers
by hand _____ 149		Activating _____ 49
Chrome parts _____ 150		Cleaning the windscreen wiper blades _____ 51
High-pressure cleaner _____ 149		Windscreen washer fluid _____ 165
Weights _____ 197		Winter operation
Wheel bolts		Snow chains _____ 176
Anti-theft wheel bolt _____ 182		Winter tyres
Caps _____ 174		see Wheels and tyres _____ 176
Loosening and tightening _____ 181		X
Wheels _____ 170		XDS _____ 97
Wheels and tyres		
Changing a wheel _____ 179		
Full wheel trim _____ 174		
General information _____ 170		
Handling wheels and tyres _____ 172		
new tyres _____ 172		
Service life of tyres _____ 171		
Snow chains _____ 176		
Spare wheel _____ 173		
Wheel bolts _____ 176		
Winter tyres _____ 176		
Window convenience operation _____ 36		
Windows		
De-icing _____ 151		
See electric power windows _____ 34		
Windscreen		
see Radio reception _____ 151		
Windscreen washer fluid		
Checking _____ 165		
Replenishing _____ 165		
Warning light _____ 24		
Winter _____ 165		

ŠKODA pursues a policy of constant product and model development. We trust that you will understand that changes to models in terms of shape, equipment and engineering, may be introduced at any time. The information about appearance, performances, dimensions, weight, standards and functions of the vehicle is correct at the time of publication. Certain items of equipment might only be installed at a later date (information provided by your local ŠKODA Service Partner) or are only offered in particular markets. It is therefore not possible for legal claims to be made based on the data, illustrations and descriptions contained in this Owner's Manual.

Reprinting, reproduction or translation, either in whole or in part, is not permitted without the written consent of ŠKODA.

ŠKODA expressly reserves all rights relating to copyright laws.

Subject to change.

Issued by: ŠKODA AUTO a.s.

© ŠKODA AUTO a.s. 2012

Minimisation of fuel consumption and CO₂ emissions

- Start-stop system*
- Recovery*
- Indication of recommended gear*

Weight reduction

- Optimisation of high-strength panels, reduction of thickness in panels and other materials
- Replacement of spare wheel with tyre repair kit

Reduction of energy consumption

- Use of energy-saving electromechanical steering instead of hydraulic type
- Optimisation of efficiency of generators
- Optimisation of operating consumption and electrical current consumption

Optimisation of aerodynamic- and rolling resistance

- Additional aerodynamic spoilers*
- Additional covers at rack (CD covers)*
- Optimised cooling (input grid, additional seal)*
- Reduction by 15 mm* with frame
- Ro-Wi tyres (wheels with low rolling resistance)*

Recyclability

- All models currently in production homologised in conformity with the requirements for recyclability (EU Directive 2005/64/EC)
- Use of recyclable, environmentally-friendly materials
- Use of recycled materials with the parameters of the new material preferred
- Labelling of materials for the purpose of making sorting easy



* realised in the GreenLine series



www.skoda-auto.com

You also can do something for the environment!

The fuel consumption of your ŠKODA and the related pollutant emissions are determined crucially on how you drive.

The noise and the wear of the vehicle depend on the way how you deal with your vehicle.

This Owner's Manual shows you how to use your ŠKODA vehicle with utmost care for the environment while driving economically at the same time.

Also please pay attention to those parts in the Owner's Manual that are marked  below.

Work with us - for the sake of the environment.

Návod k obsluze
Octavia, Laura anglicky 11.2012
S64.5610.12.20
1Z0 012 031 H